

# HOTEL CATALOGUE 2022



Hospitality Excellence since 1928



# ABOUT US

**EN** As an industry pioneer since 1928, Caddie designs and manufactures innovative handling equipment for hotels. The asset that has driven our expansion and success is the customer-centric product development enabled by our in-house design office. This has allowed us to set up a reliable, durable and functional range of trolley for housekeeping, front office, conference as well as laundry and room service.

**FR** Depuis 1928, les solutions et le service orientés vers le client ont conduit le succès et l'expansion internationale de Caddie. C'est cette expérience qui nous permet aujourd'hui de vous proposer un porte-feuille complet de solutions fiables, durables et fonctionnelles pour la réception, les étages, le service banquet et conférence, la circulation du linge et la restauration en chambre.

**IT** In qualità di pioniere fra i fornitori dell'industria alberghiera, Caddie progetta e produce carrelli e attrezzature per Hotel dal 1928. Lo studio di soluzioni atte a soddisfare qualsiasi tipo di esigenza e il nostro servizio di progettazione e ricerca sono stati i punti chiave del nostro successo a livello internazionale. La nostra esperienza ci permette di offrirvi un ventaglio di prodotti affidabili, durevoli e funzionali per reception, servizio ai piani, servizio in camera, servizio biancheria, catering e conferenze.

**DE** Als Pionier der Branche entwickelt und produziert Caddie seit 1928 innovative Hotel-Transportlösungen. Ein entscheidender Erfolgsfaktor der letzten Jahre ist zweifelsohne die kundenorientierte Produktentwicklung durch eigene Produktdesigner. Dies hat es uns ermöglicht, ein zuverlässiges, langlebiges und funktionales Sortiment an Zimmermädchenwagen sowie Front Office, Konferenz, Wäsche- und Roomservicewagen aufzubauen.



**EN** Caddie Hotel subsidiaries and distributors are located in different countries, which are strategic hubs in the international market. The concept and design phase is developed by the Italian headquarters according to the customer needs.

**IT** Caddie Hotel si avvale di magazzini e distributori dislocati in diversi paesi, punti strategici nel mercato mondiale. La progettazione parte dalla sede centrale italiana che sviluppa le soluzioni più adatte alle esigenze del cliente e del mercato.

**FR** Notre usine principale basée en Italie conçoit et développe les solutions les plus adaptées aux besoins des clients et grâce à nos différentes filiales, nous avons renforcé notre présence à l'international.

**DE** Caddie Hotel ist an mehreren, für den Hotelmarkt strategisch wichtigen Standorten durch Tochterfirmen oder Distributoren vertreten. Unser Herz und der Entwicklungsstandort liegt in Italien. Hier entwickeln und designen wir unsere bedarfsorientierten Produkte.

## GLOBAL NETWORK





# PHILOSOPHY

**EN** Caddie always stood and still stands for reliability, durability and a strong affinity for design.

Since the commercial foundation of Caddie Hotel, those product and brand characteristics are complemented by a customer oriented sales and associated service concept, led by a dedicated team with a long history and expertise in the hotel market. Together we are constantly working on solutions that support our customers in dealing with their daily challenges.

**FR** Fiabilité, longévité et design séduisant caractérisent depuis toujours la marque Caddie.

La création de Caddie Hotel a permis un support commercial complètement orienté vers nos clients, avec une équipe expérimentée dans le domaine de l'hôtellerie. Ensemble, nous collaborons constamment à la mise en œuvre de solutions facilitant le quotidien opérationnel de nos clients.

**IT** Il marchio Caddie è sinonimo di prodotti affidabili e dal design accattivante. Inoltre, con la creazione di Caddie Hotel, abbiamo aggiunto alle qualità legate al prodotto anche un supporto commerciale completamente orientato al cliente, formato da un team dedicato e con esperienza nel mercato alberghiero. Insieme collaboriamo costantemente per la creazione di soluzioni che supportino i nostri clienti nell'affrontare le loro sfide quotidiane.

**DE** Caddie Hotel - der Name steht für Zuverlässigkeit, Langlebigkeit und eine hohe Design-Affinität. Ergänzt werden diese Markeneigenschaften seit der Neufirmierung der Caddie Hotel GmbH um einen kundennah ausgerichteten Vertrieb und vor allem um ein engagiertes Team mit langjähriger Erfahrung im Hotelbereich.

Gemeinsam arbeiten wir stets daran, unsere Kunden bei ihren täglichen Herausforderungen bestmöglich zu unterstützen.

FRONT OFFICE \_\_\_\_\_ 11

Transbag One IN \_\_\_\_\_ 12  
 Transbag One BR \_\_\_\_\_ 13  
 Transbag Vip CR / BR M / L \_\_\_\_\_ 14  
 Transbag Smart CR / BR M / L \_\_\_\_\_ 15  
 Transbag Eco IN \_\_\_\_\_ 16  
 Transbag Hexa IN M / L \_\_\_\_\_ 17  
 Transbag Delta \_\_\_\_\_ 18  
 Teseo CR Easy ST / Ercole CR Easy \_\_\_\_\_ 19  
 Orsa IN / Orsa Dakar \_\_\_\_\_ 20  
 Masterinox 500 / Easy \_\_\_\_\_ 21  
 Roulstar Eco / Easy \_\_\_\_\_ 22  
 Volo / Volo GR \_\_\_\_\_ 23  
 Spiga / Cord \_\_\_\_\_ 24  
 Riga / Corda \_\_\_\_\_ 25  
 Retrax / Wall A & B \_\_\_\_\_ 26  
 Info / Display \_\_\_\_\_ 27

HOUSEKEEPING \_\_\_\_\_ 29

Bali M / L \_\_\_\_\_ 30  
 The Caddie \_\_\_\_\_ 32  
 Tahiti S / M / L \_\_\_\_\_ 34  
 Fidji S / M / L \_\_\_\_\_ 36  
 George S / M / L \_\_\_\_\_ 38  
 George XL \_\_\_\_\_ 40  
 Dakar Alu \_\_\_\_\_ 41  
 Palace Easy \_\_\_\_\_ 42  
 Capri Eco \_\_\_\_\_ 44  
 Halley 2 / Palacenet \_\_\_\_\_ 45  
 Ibiza S / M / L \_\_\_\_\_ 46  
 Easy / Samoa S / M \_\_\_\_\_ 52  
 Ambiente / Transnet \_\_\_\_\_ 48  
 Plasnet \_\_\_\_\_ 49  
 Floor Safety Sign \_\_\_\_\_ 49

LAUNDRY SERVICE \_\_\_\_\_

Caddie Sac / Hydro \_\_\_\_\_  
 Caddie Sac XS / Hydro XS \_\_\_\_\_  
 Ibiza Trisac 2 / Caddie X 2 \_\_\_\_\_  
 Caddie X / Caddie X Eco \_\_\_\_\_  
 Trisac 1 / 2 / 3 / 4 \_\_\_\_\_  
 Trisac Alu 1 / 2 / 3 / 4 \_\_\_\_\_  
 Sirio / Cesto \_\_\_\_\_  
 Bactainer Alu / Alu S/L \_\_\_\_\_  
 Bactainer 180 L / 360 L \_\_\_\_\_  
 Mobilinge \_\_\_\_\_  
 Mobilinge M / L \_\_\_\_\_  
 Roll Base / 3 / 4 \_\_\_\_\_  
 Roll Sicurezza 1/ 2 \_\_\_\_\_  
 Stender Easy / Easy HR / Stender Base Z \_\_\_\_\_



# INDEX



_____ 51	ROOM SERVICE _____ 67	FOOD SERVICE _____ 91
_____ 52	The Caddie Bar _____ 68	Coffie _____ 92
_____ 53	B-Palace Easy _____ 70	Tray Stand W _____ 93
_____ 54	Ibiza Bar M / L _____ 72	Caddinox 2 / 3 _____ 94
_____ 55	Bora Bora M / L _____ 73	Super Caddinox 2 / 3 _____ 95
_____ 56	Charlotte M / L _____ 74	Verso 12 / 12P _____ 96
_____ 57	Bali Bar _____ 75	Verso 24 / 24P _____ 97
_____ 58	Theliverie _____ 76	Alto 2 / 3 _____ 98
_____ 59	Table Flip Top _____ 77	Alto Flambè / 5PM _____ 99
_____ 60	Hot Box _____ 78	Alto Wine / Mixology _____ 100
_____ 61	Box Taxi _____ 79	Alto Bolla / Ice 3 _____ 101
_____ 62	Table Flip Top Eco 80/90 Q _____ 80	
_____ 63	Hot Box Eco _____ 81	
_____ 64	Box Taxi Eco _____ 82	
_____ 65	Passepartout 2 / 3 / PL 3 _____ 83	
	Luggage Rack CR / S / BR / S _____ 84	
	Luggage rack W-LNO / WS-LNO _____ 85	
	Lucy _____ 86	
	Foldie Eco _____ 87	
	Babybed Sleep'n Play _____ 88	
	Beddie Ergo S _____ 89	



EN	IT	FR	DE	
CASTORS	RUOTE	ROULETTES	ROLLEN	102
OPTIONS	OPTIONALS	OPTIONS	OPTIONEN	104
PANEL FINISH	FINITURE	FINITIONS	DEKORE	113



# FRONT OFFICE

**EN One of our areas of expertise:** for the secure and stylish transportation of suitcases and bags, Caddie Hotel offers a broad range of luggage carts that will fit perfectly in your hotel's interior.

**IT Una delle nostre aree di competenza:** per un trasporto elegante e sicuro dei bagagli, Caddie Hotel propone un'ampia gamma di carrelli il cui aspetto si accosta perfettamente allo stile del vostro hotel.

**FR L'un de nos secteurs d'expertise:** pour le transport élégant et sûr de bagages, Caddie Hotel propose une large gamme de chariots dont la finition et l'aspect s'inscriront parfaitement dans la décoration intérieure de votre établissement.

**DE Eines unserer Spezialgebiete:** für den sicheren und stilvollen Transport von Koffern und Taschen bietet Caddie Hotel ein großes Sortiment an Gepäckwagen, das sich optimal in das Gesamtkonzept Ihres Hotels einfügt.



THE ONE  
AND ONLY

- EN** • Highly shock-absorbent, non-marking and full wrap-around rubber bumper in anthracite color, interchangeable
- Hanging rail for coat hangers (48 cm)
  - Thick and soft velour carpet made of 100% Polyamide

- IT** • Bordo paracolpo in gomma colore antracite antiurto, antitraccia, intercambiabile
- Barra appendiabiti (48 cm)
  - Moquette spessa e soffice in poliammide 100%

- FR** • Pare-chocs intégral souple en caoutchouc non-marquant, coloris anthracite, remplaçable
- Barre penderie pour cintres (48 cm)
  - Moquette épaisse et souple 100% polyamide

- DE** • Extrem stoßdämpfender, nicht abfärbender rundum Gummistoßschutz in anthrazit, auswechselbar
- Kleiderstange (48 cm) für Kleiderbügel
  - Velour-Teppich aus 100% Polyamid

## Options



## Available colours

 Grey | Grigio | Gris | Grau  Blue | Blu | Bleu | Blau

 Red | Rosso | Rouge | Rot  Black | Nero | Noir | Schwarz

							
<b>TRANSBAG ONE IN</b>	max. 300 Kg	2 swivel and 2 fixed Ø200 mm 'RG'	Matt stainless steel tube Ø50mm Acciaio inox spazzolato Ø50mm Tubes acier inoxydable brossé Ø50mm Edelstahlrohr matt Ø50mm	1120x 650x h1920 mm	9 - 12	60 Kg	997290IN

# TRANSBAG ONE BR

THE ONE AND ONLY



- EN**
- Highly shock-absorbent, non-marking and full wrap-around rubber bumper in anthracite color, interchangeable
  - Hanging rail for coat hangers (48 cm)
  - Thick and soft velour carpet made of 100% Polyamide

- IT**
- Bordo paracolpo in gomma colore antracite antiurto, antitraccia, intercambiabile
  - Barra appendiabiti (48 cm)
  - Moquette spessa e soffice in poliammide 100%

- FR**
- Pare-chocs intégral souple en caoutchouc non-marquant, coloris anthracite, remplaçable
  - Barre penderie pour cintres (48 cm)
  - Moquette épaisse et souple 100% polyamide

- DE**
- Extrem stoßdämpfender, nicht abfärbender rundum Gummistoßschutz in anthrazit, auswechselbar
  - Kleiderstange (48 cm) für Kleiderbügel
  - Velour-Teppich aus 100% Polyamid

## Options

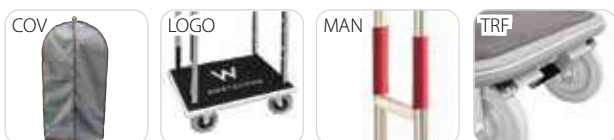

## Available colours

- Grey | Grigio | Gris | Grau
- Blue | Blu | Bleu | Blau
- Red | Rosso | Rouge | Rot
- Black | Nero | Noir | Schwarz

<b>TRANSBAG ONE BR</b>	max. 300 Kg	2 swivel and 2 fixed Ø200 mm 'RG'	Brass plated steel tube Ø50 mm Tubo in acciaio ottonato Ø50 mm Tubes en acier plaqué laiton Ø50 mm Messingrohr massiv Ø50 mm	1120x 650x h1920 mm	9 - 12	60 Kg	99720909

## TRANSBAG VIP CR M / L

## TRANSBAG VIP BR M / L



TRANSBAG VIP CR L



TRANSBAG VIP BR L

- EN**
- Non-marking and full wrap-around rubber bumper in light grey
  - Hanging rail for coat hangers (48 cm)
  - Thick and soft velour carpet made of 100% polyamide

- IT**
- Bordo paracolpo in gomma antitraccia colore grigio chiaro.
  - Barra appendiabiti (48 cm)
  - Moquette spessa e soffice in poliammide 100%



- FR**
- Pare-chocs intégral en caoutchouc non-marquant gris
  - Barre penderie pour cintres (48 cm)
  - Moquette épaisse et souple 100% polyamide

- DE**
- Nicht abfärbender rundum Gummistoßschutz in hellgrau
  - Kleiderstange (48 cm) für Kleiderbügel
  - Velour-Teppich aus 100% Polyamid







## Options



## Available colours

 Grey | Grigio | Gris | Grau  Blue | Blu | Bleu | Blau

 Red | Rosso | Rouge | Rot  Black | Nero | Noir | Schwarz

							
<b>TRANSBAG VIP CR M</b>	max. 300 Kg	2 swivel and 2 fixed Ø200 mm 'RG'	Steel tube with chrome finish Ø 40 mm Tubo in acciaio cromato Ø40 mm	935x 645x h1997 mm	8 - 10	41 Kg	010001CR
<b>TRANSBAG VIP CR L</b>			Tubes acier chromé Ø40mm Stahlrohr verchromt Ø40 mm	1130x 650x h1997 mm	9 - 12	45 Kg	010002CR
<b>TRANSBAG VIP BR M</b>			Brass plated steel tube Ø40 mm Tubo in acciaio ottonato Ø40 mm	935x 645x h1997 mm	8 - 10	41 Kg	010001BR
<b>TRANSBAG VIP BR L</b>			Tubes en acier laitoné Ø40 mm Messingrohr massiv Ø40 mm	1130x 650x h1997 mm	9 - 12	45 Kg	010002BR

## TRANSBAG SMART CR M / L

## TRANSBAG SMART BR M / L



TRANSBAG SMART CR L



TRANSBAG SMART BR L

- EN**
- Non-marking and full wrap-around rubber bumper in light grey
  - Hanging rail for coat hangers (48 cm)
  - Durable carpet made of 100% Polypropylene

- IT**
- Bordo paracolpo in gomma antitraccia colore grigio chiaro
  - Barra (48 cm) per appendere i cappotti
  - Moquette di lunga durata in polipropilene 100%

- FR**
- Pare-chocs intégral en caoutchouc gris clair
  - Barre penderie pour cintres (48 cm)
  - Moquette très résistante 100% polypropylène

- DE**
- Nicht abfärbender rundum Gummistoßschutz in hellgrau
  - Kleiderstange (48 cm) für Kleiderbügel
  - Strapazierfähiger Teppich aus 100% Polypropylen

### Options

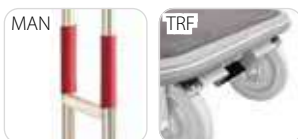

### Available colours

- Grey | Grigio | Gris | Grau
- Blue | Blu | Bleu | Blau
- Red | Rosso | Rouge | Rot
- Black | Nero | Noir | Schwarz

<b>TRANSBAG SMART CR M</b>	max. 300 Kg	2 swivel and 2 fixed Ø200 mm 'RG'	Steel tube with chrome finish Ø40mm Tubo in acciaio cromato Ø40 mm	891x 645x h1910 mm	8 - 10	40 Kg	CAD00050
<b>TRANSBAG SMART CR L</b>			Tubes acier chromé Ø40mm Stahlrohr verchromt Ø40 mm	1091x 650x h1910 mm	9 - 12	44 Kg	CAD00048
<b>TRANSBAG SMART BR M</b>			Brass plated steel tube Ø40 mm Tubo in acciaio ottonato Ø40 mm	891x 645x h1910 mm	8 - 10	40 Kg	CAD00055
<b>TRANSBAG SMART BR L</b>			Messingrohr massiv Ø40 mm	1091x 650x h1910 mm	9 - 12	44 Kg	CAD00056





NEW



- EN**
- Non-marking and full wrap-around rubber bumper
  - Hanging rail for coat hangers
  - Black carpet
  - 2 swivel castors with brake and 2 fixed

- IT**
- Bordo paracolpo in gomma antiurto, antitraccia
  - Barra appendiabiti
  - Moquette nera
  - 2 ruote girevoli con freno e 2 ruote fisse

- FR**
- Pare-chocs intégral en caoutchouc non-marquant
  - Barre penderie pour cintres
  - Moquette noir
  - 2 ruolettes pivotantes avec frein et 2 fixes

- DE**
- Extrem stoßdämpfender, nicht abfärbender rundum Gummistoßschutz
  - Kleiderstange für Kleiderbügel
  - Velour-Teppich schwarz
  - 2 Bockrollen, davon 2 Lenk-Bremsrollen

<b>TRANSBAG ECO IN</b>	max. 150 Kg	4 swivel Ø200 mm	Brushed stainless steel tube Ø40mm Tubo in acciaio inox spazzolato Ø40mm Tubes acier inoxydable brossé 40mm Edelstahlrohr matt Ø40mm	1100x 620x h1980 mm	9 - 12	48,5 Kg	CAD00127





## TRANSBAG HEXA IN M / L



TRANSBAG HEXA IN L

- EN**
- Non-marking and full wrap-around rubber bumper
  - Hanging rail for coat hangers
  - Dark grey carpet
  - 2 swivel castors with brake and 2 fixed

- IT**
- Bordo paracolpo in gomma antiurto, antitraccia
  - Barra appendiabiti
  - Moquette grigia scura
  - 2 ruote girevoli con freno e 2 ruote fisse

- FR**
- Pare-chocs intégral en caoutchouc non-marquant
  - Barre penderie pour cintres
  - Moquette gris foncé
  - 2 roues pivotantes avec frein et 2 fixes

- DE**
- Extrem stoßdämpfender, nicht abfärbender rundum Gummistoßschutz
  - Kleiderstange für Kleiderbügel
  - Elour-Teppich dunkelgrau
  - 2 Bockrollen, davon 2 Lenk-Bremsrollen

<b>TRANSBAG HEXA IN M</b>	max. 300 Kg	2 swivel and 2 fixed x Ø160 mm	Stainless steel tube Tubo in acciaio inox Tubes acier inoxydable Edelstahlrohr	790x 590x h1890 mm	6 - 8	38 Kg	CAD00257
<b>TRANSBAG HEXA IN L</b>				990x 590x h1890 mm	7 - 9	40 Kg	CAD00255





NEW

- EN** • Non-marking and full wrap-around rubber bumper in black  
• Hanging rail for coat hangers  
• Wooden base with dark blue carpet
- IT** • Bordo paracolpo in gomma antitraccia nera  
• Barra appendiabiti  
• Base in legno con moquette blu scura

- FR** • Pare-chocs intégral en caoutchouc noir  
• Barre penderie pour cintres  
• Socle en bois avec moquette blue foncé
- DE** • Nicht abfärbender rundum Gummistoßschutz in Schwarz  
• Kleiderstange für Kleiderbügel  
• Holzsockel elour-Teppich dunkelblau

<b>TRANSBAG DELTA</b>	max. 150 Kg	4 swivel Ø200 mm	Steel tube with chrome finish Ø 40 mm Tubo in acciaio cromato Ø40 mm Tubes acier chromé Ø40mm Stahlrohr verchromt Ø40 mm	950x 550x h1830 mm	8 - 10	34 Kg	CAD00254

## TESEO CR EASY ST



NEW

- EN**
- 4 rubber bumper rings at corners
  - Durable carpet made of 100% Polypropylene
  - Side pushing bars
  - Stainless steel sheet deck (TESEO CR EASY ST)
  - Grey rubber bumper rings at corners

- FR**
- Pare-chocs angulaires
  - Moquette très résistante 100% polypropylène
  - Poignée de poussée
  - Base pleine in acier inoxydable (TESEO CR EASY ST)
  - Pare-chocs angulaires









## ERCOLE CR EASY



NEW

- IT**
- Angoli con paracolpi in gomma grigia
  - Moquette di lunga durata in polipropilene 100%
  - Maniglioni di spinta
  - Base in lamiera in acciaio inox (TESEO CR EASY ST)
  - Angoli con paracolpi in gomma grigia

- DE**
- Seitliche Abweisinge
  - Strapazierfähiger Teppich aus 100% Polypropylen
  - Schiebebügel
  - Bodenplatte in Edelstahl (TESEO CR EASY ST)
  - Seitliche Abweisinge

							
<b>TESEO CR EASY ST</b>	max. 200 Kg	4 swivel x Ø140 mm	Stainless steel tube Tubo in acciaio inox Tubes acier inoxydable Edelstahlrohr	1000x 560x h1600 mm	6 - 7	25 Kg	CAD00166 
<b>ERCOLE CR EASY</b>		2 swivel and 2 fixed x Ø160 mm	Sheet metal desk and steel tube Lamiera e tubo di acciaio Tôle et tube en acier Blech- und Stahlrohr	1440x 660x h950 mm	10 - 12	36 Kg	CAD1894.1 



# ORSA IN / ORSA DAKAR



ORSA IN



ORSA DAKAR

- EN**
- Space-saving foldable when not in use
  - Sheathed handle (with plastic grip)
  - Durable carpet made of 100% Polypropylene

- IT**
- Pieghevole quando non in uso
  - Impugnatura in plastica
  - Moquette di resistenti in polipropilene 100%

- FR**
- Plateforme repliable et rails de pose avec protection
  - Poignée gainée
  - Moquette très résistante 100% polypropylène

- DE**
- Platzsparend zusammenklappbar bei Nichtgebrauch
  - Ummantelter Handgriff
  - Strapazierfähiger Teppich aus 100% Polypropylen

**Available colours**

- Grey | Grigio | Gris | Grau
- Blue | Blu | Bleu | Blau
- Red | Rosso | Rouge | Rot
- Black | Nero | Noir | Schwarz

<b>ORSA IN</b>	max. 150 Kg	2 x Ø300 mm 'PNP'	Stainless steel Ø28 mm Acciaio inox Ø28 mm Acier inoxydable Ø28 mm Edelstahlrohr gebürstet Ø28 mm	1052 (open)/ 409 (closed) x 573x h1217 mm	6 - 7	30 Kg	010500IN
<b>ORSA DAKAR</b>		2 pneumatic x Ø260 mm 'TT'		1080 (open)/411x 625 (close)x h1101 mm			010501IN

## MASTERINOX 500



MASTERINOX 500

- EN** • Full stainless steel sheet platform  
• Stainless steel tube handle  
• Pushing handle

- FR** • Plateau en acier inoxydable  
• Poignée en tube d'acier inoxydable  
• Poignée de poussée

## MASTERINOX EASY



MASTERINOX EASY

- IT** • Piattaforma liscia in acciaio inox  
• Manico in tubo di acciaio inox  
• Maniglione di spinta

- DE** • Edelstahl Bodenplatte  
• Rohrgriff aus Edelstahl  
• Mit Schiebebügel

	 KG				 KG	 CODE
<b>MASTERINOX 500</b>	max. 500 Kg	2 swivel and 2 fixed Ø200 mm	Stainless steel Acciaio inox Acier inoxydable	1060x 560x h1045 mm	25 Kg	100302IN
<b>MASTERINOX EASY</b>	max. 200 Kg	2 swivel and 2 fixed Ø140 mm	Edelstahl	1100x 600x h970 mm	15 Kg	CAD00165



**NEW**



## ROULSTAR ECO

NEW



ROULSTAR ECO

## ROULSTAR EASY

NEW









ROULSTAR EASY

- EN** • Polyethylene based  
• Pushing handle foldable (ECO) or fixed (EASY) handle

- IT** • Base in polietilene  
• Maniglione di spinta pieghevole (ECO) o fisso (EASY)

- FR** • Plateau en polyéthylène  
• Poignée de poussée pliable (ECO) ou fixe (EASY)

- DE** • Bodenplatte in Polyethylen  
• Mit Schiebebügel  
• Faltbarer (ECO) und fester (EASY) Griff

						
<b>ROULSTAR ECO</b>	max. 200 kg	2 swivel and 2 fixed x Ø140 mm	Steel tube and polyethylene	950x 570x h870 mm	13 Kg	CAD00164
<b>ROULSTAR EASY</b>			Tube in metallo e polietilene Tube en acier et polyéthylène Stahlrohr und Polyethylen	1070x 570x h970 mm	14 Kg	CAD00251

## VOLO



## VOLO GR



- EN**
- Nestable
  - 2 front donut bumper
  - Upper basket for hand luggage, with hook for bags (VOLO)
  - Upper basket for hand luggage and clothes hanger bar (VOLO GR)

- IT**
- Impilabile
  - 2 paracolpi frontali
  - Cestino superiore per bagagli a mano con gancio per borse (VOLO)
  - Cestino superiore per bagagli a mano e barra appendiabiti (VOLO GR)

- FR**
- Emboîtable
  - 2 pare-chocs angulaire à l'avant
  - Panier supérieur pour bagages à main, porte sac intégré à l'avant (VOLO)
  - Panier supérieur pour bagages à main et barre penderie pour cintres (VOLO GR)

- DE**
- Stapelbar
  - 2 Abweisringe
  - Oberer Korb für Handgepäck, mit Taschenaufhängung (VOLO)
  - Oberer Korb für Handgepäck, mit Taschenaufhängung Kleiderbügel (VOLO GR)

## Options



<b>VOLO</b>	max. 250 Kg	2 swivel front x Ø125 mm and 2 rear x Ø200 mm, with ball bearing, with rubber tread	Steel tube electrolytic galvanized, with clear coat Struttura in tubo d'acciaio con zincatura elettrolitica con copertura in vernice trasparente	1015x 600x h970 mm	3 - 4	18 Kg	VOLO001
<b>VOLO GR</b>			Tubes acier finition électro galvanisée vernie Stahlrohr verzinkt, mit Klarlacküberzug	1015x 600x h1700 mm		19,5 Kg	CAD00061

## SPIGA

## CORD



SPIGA BR

SPIGA IN



CORD R BR

CORD B CR

CORD N CR

CORD Z BR

- EN** • Possibility to add Display or ropes  
• Head with hollowed crown so as to fix a snap hook

- IT** • Possibilità di fissaggio Display  
• Disco piatto con ghiera per il fissaggio di moschettoni

- FR** • Possibilité d'ajouter des panneaux d'informations ou des cordes  
• Tête avec couronne évidée





- DE** • Möglichkeit zum Hinzufügen von Display oder Kordeln  
• Flacher Kopf mit Befestigung für Kordel-Karabiner

- EN** • Twisted rope 1500 mm available in: red, blue, cream and black  
• Snap hook in steel (CR) or brassed finish (BR)

- IT** • Corda intrecciata 1500 mm disponibile in: rosso, blu, crema e nero  
• Moschettone in acciaio (CR) o finitura ottonata (BR)

- FR** • Cordon torsadé 1500 mm disponible en: rouge, bleu, crème et noir  
• Mousqueton en acier inoxydable (IN) ou finition laiton (BR)

- DE** • Gedrehte Kordel 1500 mm erhältlich in: rot, blau, beige und schwarz  
• Karabinerhaken aus Stahl verchromt (CR) oder vermessingt (BR)

				
<b>SPIGA IN</b> <b>SPIGA BR</b>	Stainless steel with chrome (IN) / brass (BR) finish Acciaio inox con finitura cromata (IN) / ottonata (BR) Tubes acier inoxydable chromé (IN) / finition laiton (BR) Edelstahl, verchromt (IN) / Stahl, vermessingt (BR)	Ø base 360x Ø post 50x h910 mm Ø base 360x Ø tubo 50x h910 mm Ø base 360x Ø poteau 50x h910 mm Ø base 360x Ø Pfosten 50x h910 mm	13 Kg	030100IN 030100BR
<b>CORD R CR</b> <b>CORD R BR</b>	Red, chrome snap hook finish (CR) / Red, brass snap hook finish (BR) Corda rossa con moschettoni cromati (CR) / ottonati (BR) Rouge: mousqueton finition chromée (CR) / laiton (BR) Rot, Endstück verchromt (CR) / Rot, Endstück vermessingt (BR)	1500 mm	0.8 Kg	030301CR 030301BR
<b>CORD B CR</b> <b>CORD B BR</b>	Blue, chrome snap hook finish (CR) / Blue, brass snap hook finish (BR) Corda blu con moschettoni cromati (CR) / ottonati (BR) Bleu: mousqueton finition chromée (CR) / laiton (BR) Blau, Endstück verchromt (CR) / Blau, Endstück vermessingt (BR)			030302CR 030302BR
<b>CORD N CR</b> <b>CORD N BR</b>	Cream, chrome snap hook finish (CR) / Cream, brass snap hook finish (BR) Corda color crema con moschettoni cromati (CR) / ottonati (BR) Crème: mousqueton finition chromée (CR) / laiton (BR) Beige, Endstück verchromt (CR) / Beige, Endstück vermessingt (BR)			030303CR 030303BR
<b>CORD Z CR</b> <b>CORD Z BR</b>	Black, chrome snap hook finish (CR) / Black, brass snap hook finish (BR) Corda nera con moschettoni cromati (CR) / ottonati (BR) Noir: mousqueton finition chromée (CR) / laiton (BR) Schwarz, Endstück verchromt (CR) / Schwarz, Endstück vermessingt (BR)			030304CR 030304BR



## RIGA



RIGA BR

RIGA IN

## CORDA



CORDA R CR



CORDA B BR



CORDA N CR

NEW



- EN** • Possibility to add Display (with opt. Supp) or ropes  
• Head with hollowed crown so as to fix a snaphook

- IT** • Possibilità di aggiungere Display, con l'ausilio del Supp o corde  
• Disco piatto con ghiera per il fissaggio di moschettoni

- FR** • Possibilité d'ajouter des panneaux d'informations avec option Supp ou des cordes  
• Tête avec couronne évidée

- DE** • Möglichkeit zum Hinzufügen von Display (mit opt. Supp) oder Kordeln  
• Flacher Kopf mit Befestigung für Kordel-Karabiner

- EN** • Twisted rope 1500 mm available in: red, blue and black  
• Snap hook in steel (CR) or brassed finish (BR)

- IT** • Corda intrecciata 1500 mm disponibile in: rosso, blu e nero  
• Moschettoni in acciaio (CR) o finitura ottonata (BR)

- FR** • Cordon torsadé 1500 mm disponible en: rouge, bleu et noir  
• Mousqueton en acier inoxydable (IN) ou finition laiton (BR)

- DE** • Gedrehte Kordel 1500 mm erhältlich in: rot, blau und schwarz  
• Karabinerhaken aus Stahl verchromt (CR) oder vermessingt (BR)

<b>RIGA IN</b> <b>RIGA BR</b>	Stainless steel with matt (IN) / brass (BR) finish Acciaio inox (IN) / con finitura ottonata (BR) Tubes acier inoxydable brossé (IN) / finition laiton (BR) Edelstahl Stahl (IN) / Stahl, vermessingt (BR)	Ø base 320x Ø post 50x h970 mm Ø base 320x Ø tubo 50x h970 mm Ø base 360x Ø poteau 50x h910 mm Ø base 320x Ø Pfosten 50x h970 mm	5,5 Kg	CAD00086 CAD00045
<b>CORDA R CR</b> <b>CORDA R BR</b>	Red, chrome snap hook finish (CR) / Red, brass snap hook finish (BR) Corda rossa con moschettoni cromati (CR) / ottonati (BR) Rouge: mousqueton finition chromée (CR) / laiton (BR) Rot, Endstück verchromt (CR) / Rot, Endstück vermessingt (BR)	1500 mm	0.6 Kg	CAD00087 CAD00089
<b>CORDA B CR</b> <b>CORDA B BR</b>	Blue, chrome snap hook finish (CR) / Blue, brass snap hook finish (BR) Corda blu con moschettoni cromati (CR) / ottonati (BR) Bleu: mousqueton finition chromée (CR) / laiton (BR) Blau, Endstück verchromt (CR) / Blau, Endstück vermessingt (BR)			CAD00088 CAD00090
<b>CORDA N CR</b> <b>CORDA N BR</b>	Black, chrome snap hook finish (CR) / Black, brass snap hook finish (BR) Corda nera con moschettoni cromati (CR) / ottonati (BR) Noir: mousqueton finition chromée (CR) / laiton (BR) Schwarz, Endstück verchromt (CR) / Schwarz, Endstück vermessingt (BR)			CAD00214 CAD00215

## RETRAX / WALL A &amp; B



RETRAX BR

RETRAX IN

RETRAX INS

RETRAX BK



WALL A



WALL B

## Available colours



## Options



**EN RETRAX**  
• Length of belt 2500 mm

**WALL A**  
• Black steel casing  
• Length of the belt 2500 mm

**WALL B**  
• Stainless steel clip to be used opposite to WALL A or RETRAX

**IT RETRAX**  
• Lunghezza nastro 2500 mm

**WALL A**  
• Conchiglia colore nero  
• Lunghezza nastro 2500 mm

**WALL B**  
• Ricevitore nastro in acciaio inox

**FR RETRAX**  
• Longueur de la sangle: 2500 mm

**WALL A**  
• Coque en acier peint finition noire  
• Longueur de la sangle: 2500 mm

**WALL B**  
• Clip de fixation de sangle à installer pour recevoir la sangle du WALL A ou du RETRAX

**DE RETRAX**  
• Zugband mit einer Länge von ca. 2500 mm

**WALL A**  
• Schwarz lackiertes Stahlgehäuse  
• Bandlänge ca. 2500 mm

**WALL B**  
• Edelstahl-Wandhalterung für Zugband

<b>RETRAX BR</b>	Stainless steel with brass finish Acciaio inox con finitura ottonata Tubes acier inoxydable finition laiton Edelstahl vermessingt	Ø base 340x Ø post 64x h985 mm	14 Kg	030401BR
<b>RETRAX IN</b>	Stainless steel with chrome finish Acciaio inox con finitura cromata Tubes acier inoxydable chromé Edelstahl glänzend	Ø base 340x Ø post 64x h985 mm		030401IN
<b>RETRAX INS</b>	Stainless steel with brush finish Acciaio inox con finitura spazzolata Tubes acier inoxydable brossé Edelstahl matt	Ø base 340x Ø post 64x h985 mm		030401INS
<b>RETRAX BK</b>	Steel with black matt finish Acciaio con finitura nera opaca Tubes acier finition noire Stahlrohr schwarz pulverbeschichtet	Ø base 340x Ø post 64x h985 mm		030401BK
<b>WALL A</b>	Painted steel Acciaio verniciato Acier peint Lackierter Stahl	Ø 70 x h110	1 Kg	030402
<b>WALL B</b>	Stainless Steel Acciaio Inox Acier Inoxydable Edelstahl	-	0.5 Kg	030403

## INFO / DISPLAY



INFO A4 IN



INFO A3 BR



DISPLAY A4 BR



DISPLAY A3 CR

**EN INFO KIT**

- Info Kit is composed of DISPLAY and SPIGA and optional SUPP

**DISPLAY**

- Information panels can be used in portrait or landscape orientation
- Including support (SUPP) for fixing to post

**IT INFO KIT**

- Il Kit Info è composto da DISPLAY e SPIGA con l'ausilio dell'optional SUPP

**DISPLAY**

- Pannello display che può essere usato sia in posizione orizzontale che verticale
- Compreso di supporto (SUPP) per l'aggancio alla colonnina

**FR INFO KIT**

- Le Kit Info est composé par le poteau SPIGA et le panneau d'information DISPLAY avec option SUPP

**DISPLAY**





- Panneau d'information versatile en format portrait ou paysage.
- Y compris le support (SUPP) pour le couplage à la colonne

**DE INFO KIT**

- Das Info-Kit besteht aus DISPLAY und SPIGA (mit opt. Supp)

**DISPLAY**

- Informationstafeln können im Hoch- oder Querformat verwendet werden
- Inklusive Stütze (SUPP) zum Anknüpfen an die Säule

			 KG	 CODE
<b>DISPLAY A4 CR</b> <b>DISPLAY A4 BR</b>	Outer frame chrome with black inner frame (CR) / gold-colored inner frame (BR) Display cromato, con cornice interna nera (CR) / dorata (BR) Cadre intérieur noir (CR) / doré (BR)	275x 360 mm	1 Kg	030201CR 030201BR
<b>DISPLAY A3 CR</b> <b>DISPLAY A3 BR</b>	Infotafel DISPLAY mit innerem schwarzen Rahmen (CR) / innerem goldoptik Rahmen (BR)	360x 485 mm	1.5 Kg	030202CR 030202BR
<b>INFO A4CR</b> <b>INFO A4BR</b>	Steel base with chrome (CR) and brass finish (BR) / Outer frame chrome with black inner frame (CR) / gold-colored inner frame (BR) Colonnina cromata (CR) / ottonata (BR) con display cromato con cornice interna nera (CR) / dorata (BR)	275x 360 mm	14 Kg	030201CR KIT 030201BR KIT
<b>INFO A3CR</b> <b>INFO A3BR</b>	Poteau et pied en acier, finition chromée (CR) / laiton (BR), cadre intérieur noir (CR) / doré (BR) Absperrständer SPIGA in Stahl verchromt (CR) / vermessingt (BR) mit Infotafel DISPLAY mit innerem schwarzen Rahmen (CR) / innerem goldoptik Rahmen (BR)	360x 485 mm	14.5 Kg	030202CR KIT 030202BR KIT





# HOUSEKEEPING

**EN As a pioneer in the sector,** we have built a strong experience which gives us a solid understanding of what is needed for a professional and efficient housekeeping service.

**IT Pionieri del settore,** abbiamo acquisito una forte esperienza che ci permette di capire i bisogni dei nostri clienti per un servizio ai piani professionale ed efficace.

**FR Pionnier dans ce secteur,** nous avons acquis une forte expérience, contribuant ainsi à une solide compréhension des besoins de nos clients, pour un travail professionnel et efficace dans les étages.

**DE Als der Pionier** in diesem Bereich wissen wir, worauf es bei einem professionellen und effektiven Housekeeping ankommt.



# BALI M / L



BALI L

**SATELLITE**  
removable trolley with  
waste bag and cover



BALI M  
(CAD00210) + OPTIONS: SATELLITE, SAC, LID,  
KC, DH, D, RNY

- EN**
- 2 height adjustable shelves
  - Lockable doors and lid (OPT)
  - 4 donut bumpers

- IT**
- 2 ripiani regolabili in altezza
  - Porte e coperchio muniti di serratura (OPT)
  - 4 ruote paracolpo ricoperte di gomma antitraccia

- FR**
- 2 étagères ajustables
  - Portes et couvercle verrouillables (OPT)
  - Pare-chocs angulaire

- DE**
- 2 höhenverstellbare Einlegeböden
  - Abschließbare Tür und Deckel (OPT)
  - 4 Abweisinge

<b>BALI M</b>	max. 150 Kg	4 swivel x Ø150 mm 'CMP'; 2 of which with brake	Steel tubing structure with HPL panels Struttura in tubo d'acciaio con pannelli HPL	900x 590x h1290 mm	1600x 590x h1290 mm	9 - 12	68 Kg	CAD00210
<b>BALI L</b>			Structure en tubes d'acier avec panneaux en HPL Stahlrohrrahmen mit HPL-Platten	1100x 590x h1290 mm	1900x 590x h1290 mm	12-15	90 Kg	CAD00250

**NEW**



BALI KIT

**BALI KIT: Fully operational solutions**

Basic model

Option PVC



Option SAC

**Options**



**Panel Finish**

HPL



SFB

SOM

SWE

SNE



caddie



**TOTALLY  
CUSTOMIZABLE**

## Trendie



- EN Turn-down service bag. Compact, ergonomic and versatile quick solution for an impeccable service.
- IT Borsa per il servizio alle camere. Soluzione rapida e compatta, ergonomica e versatile, per un servizio rapido e impeccabile.
- FR Sac Turn-Down compact pour un service polyvalent impeccable, rapide et ergonomique.
- DE Faltbare Servicetasche: Eine kompakte, ergonomische und vielseitige Lösung für einen tadellosen, schnellen Service.



## Handie



- EN Customizable housekeeping trolley. Discreet, silent and lightweight cart for a stylish and efficient service.
- IT Carrello per le pulizie personalizzabile. Discreto, silenzioso e leggero per un servizio elegante ed efficiente.
- FR Valisette personnalisable pour un service d'étage élégant, discret, silencieux et efficace.
- DE Anpassbarer Reinigungswagen. Dezent, leise und leicht für einen eleganten und effizienten Service.



= 3

## Buddie



- EN A complete set of 2 separate elements brought together for an impeccable and efficient invisible housekeeping service.
- IT Un set completo di 2 elementi separati riuniti per un servizio di pulizia invisibile, impeccabile ed efficiente.
- FR Un ensemble comprenant le deux différents éléments pour un service en chambre complet.
- DE Die Kombination aus 2 separaten Elementen sorgt für ein unsichtbares und gleichzeitig effizientes Housekeeping.



**ON DEMAND  
ECO-LEATHER  
FINISH**

### Available colours



RE - Red



BR - Brown



BL - Blue



BK - Black



RAL 15 pieces MOQ.

### Options



000LID

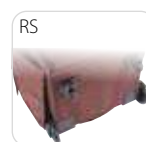

RS



SAC-B



- EN** **1** Heavy duty fastening strap secures the Trendie from falling  
**2** Strong with elastic fastening or strap wraps around the sticks on pocket with removable and washable plastic pocket liners for an unmatched hygiene.  
**3** Rigid plastic drawer with inner adjustable velcro dividers that can be washed and rinsed with water
- FR** **1** Une solide sangle permet de fixer le Trendie  
**2** Le contenu des poches est protégé par des sangles élastiques et résistantes. Les séparateurs sont amovibles et lavables.  
**3** Casier en plastique rigide avec séparateurs vélcro amovibles. Lavable à l'eau.

- IT** **1** Fascia elastica di fissaggio  
**2** Tasche dotate di fodere con velcro o fisse in plastica lavabili per un'igiene impareggiabile.  
**3** Divisori interni regolabili in plastica rigida. I divisori possono essere rimossi e il cassetto può essere lavato.
- DE** **1** Mit Aufsteckband zum Fixieren am HANDIE.  
**2** Die beiden Seitentaschen wurden zum Verstauen von Reinigungsmitteln und z.B. 1 Besen konzipiert und sind abwaschbar.  
**3** Die Schubladen sind komplett herausnehmbar. Sie verfügen über ein Trennwandsystem auf Klettverschlussbasis, das abnehmbar sowie waschbar ist.

**Handie Kit**

Handie basic model

+

Option  
RS

Option SAC-B

Option  
LID**Buddie Kit**

Handie Kit



+

Trendie











# Handie EASY

- EN** Black housekeeping trolley. Practically and essential, ensure our best combination of design and quality.
- IT** Carrello per le pulizie in tessuto nero. Trolley pratico ed essenziale che garantisce il miglior rapporto qualità prezzo.
- FR** Valisette noir. Ce modèle offrant un excellent rapport qualité/prix.
- DE** Reinigungswagen praxistauglich vorkonfiguriert mit Verbessertem Preis-Leistungsverhältnis.



XX=\*CODE COLOR  
 COD. COLORE  
 CODE COULEUR  
 FARB CODE

					 Rooms		 CODE
<b>TRENDIE</b>	max. 10/15 Kg	-	PVCP (Hydrepellent PVC-coated Polyester 600)	450x 380x h270 mm	1	2,9 Kg	050602XX*
<b>HANDIE</b>	max. 25/30 Kg	2 x Ø 110 mm 2 x Ø 50 mm	PVCP (poliestere 600 idrorepellente rivestito in PVC)	450x 380x h620 mm	2	8,8 Kg	050601XX*
<b>BUDDIE</b>	max. 35/45 Kg	2 x Ø 110 mm 2 x Ø 50 mm	PVCP (impermeable recouvert en polyester 600) Wasserdichtes PVC-beschichtetes Polyester 600	450x 380x h890 mm	2-3	11,7 Kg	050603XX*
<b>HANDIE EASY</b>	max. 25/30 Kg	2 x Ø 100 mm		460x 460x h630 mm	2	8,8 Kg	050601EY 





TAHITI L



TAHITI S KIT + OPT. E/R AND BP

- EN**
- 2 height adjustable shelves
  - Non marking and full wrap-around rubber bumper
  - Top level with retaining bars

- IT**
- 2 ripiani regolabili in altezza
  - Bordo paracolpo in gomma antistraccia
  - Ripiano superiore con spondine di protezione

- FR**
- 2 étagères ajustables
  - Pare-chocs intégral non-marquant
  - Plateau supérieur avec barres de rétention

- DE**
- 2 höhenverstellbare Einlegeböden
  - Nicht abfärbender rundum Gummistoßschutz
  - Oberste Ebene mit Schutzreling

					Max size	Rooms	KG	CODE
<b>TAHITI S</b>	max. 150 Kg	4 swivel x Ø 150 mm CMP; 2 of which with brake	Steel tubing structure with HPL panels	690x 566x h1491mm	1350x 566x h1333mm	7 - 10	37 Kg	050202HPL
<b>TAHITI M</b>			Struttura in tubo d'acciaio con pannelli HPL	890x 566x h1491mm	1550x 566x h1333mm	10 - 13	44 Kg	050203HPL
<b>TAHITI L</b>			Structure en tubes d'acier avec panneaux en HPL	1096x 566x h1491mm	1770.5x 566x h1333mm	13 - 16	52 Kg	050204HPL



TAHITI L KIT

**BESTSELLER**

**TAHITI KIT: Fully operational solutions**

Basic model (Tahiti S/M/L)

Option PVC + Option SAC

**Options**



**Panel Finish**





FIDJI M



FIDJI S KIT + OPT. BP

- EN** • 2 height adjustable shelves  
 • Non marking and full wrap-around rubber bumper  
 • Top level with retaining bars

- IT** • 2 ripiani regolabili in altezza  
 • Bordo paracolpo in gomma antitraccia  
 • Ripiano superiore con spondine di protezione

- FR** • 2 étagères ajustables  
 • Pare-chocs intégral non-marquant  
 • Plateau supérieur avec barres de rétention

- DE** • 2 höhenverstellbare Einlegeböden  
 • Nicht abfärbender rundum Gummistoßschutz  
 • Oberste Ebene mit Schutzreling

FIDJI < TAHITI → | 8 cm | ←

TAHITI 56,6 cm

FIDJI 48,5 cm

16 15 14 13 12 11 10 9 8 7 6 5 4 3 2



FIDJI L KIT+ OPT: BP, D, C

**FIDJI KIT: Fully operational solutions**

Basic model (Fidji S/M/L)



**Options**



**Panel Finish**



					Max size	Rooms		CODE
<b>FIDJI S</b>	max. 150 Kg	4 swivel x Ø150 mm 'CMP'; 2 of which with brake	Steel tubing structure with HPL panels	690x 485x h1491mm	1350x 485x h1333mm	5 - 8	27 Kg	050402HPL
<b>FIDJI M</b>			Struttura in tubo d'acciaio con pannelli HPL	890x 485x h1491mm	1550x 485x h1333mm	9 - 12	34 Kg	050403HPL
<b>FIDJI L</b>			Structure en tubes d'acier avec panneaux latéraux et arrière en HPL Stahlrohrrahmen mit HPL-Platten	1096x 485x h1491mm	1770.5x 485x h1333mm	12 - 15	42 Kg	050404HPL





GEORGE L



GEORGE M + OPT: PVC, SAC, E

- EN** • 2 height adjustable shelves
- Non marking and full wrap-around rubber bumper
  - Top level and amenity box with adjustable separators for convenient organization

- FR** • 2 étagères ajustables
- Pare-chocs intégral non-marquant
  - Cavité supérieure avec séparateurs ajustables pour l'organisation des produits d'accueil

- IT** • 2 ripiani regolabili in altezza
- Bordo paracolpo in gomma antitraccia
  - Ripiano superiore dotato di un vano porta oggetti con separatori regolabili

- DE** • 2 höhenverstellbare Einlegeböden
- Nicht abfärbender rundum Gummistoßschutz
  - Oberste Etage mit integriertem Kleinartikelkasten mit variabler Inneneinteilung
  - Mit Schiebebügel

### Panel Finish

LAM



LNO

LWE

LAN

LNE

LNV

LBE

LWS

LOM

LBV

LTR

LCO



GEORGE S KIT

**GEORGE KIT: Fully operational solutions**

Basic model (George S/M/L)

Option PVC



Option SAC

**Options**

		Not available for S size					

<b>GEORGE S</b>	max. 150 Kg	4 swivel x Ø150 mm "CMP" 2 of which with brake	Laminated wood Legno laminato Bois mélaminé Melaminharzbeschichtetes Holz	630x 570x h1474 mm	1306.5x 570x h1270 mm	5 - 8	45 Kg	050102WD
<b>GEORGE M</b>				830x 570x h1474 mm	1510x 570x h1270 mm	10 - 13	55 Kg	050103WD
<b>GEORGE L</b>				1030x 570x h1474 mm	1706x 570x h1270 mm	12 - 15	64 Kg	050104WD



NEW



- EN**
- 2 height adjustable shelves
  - Non marking and full wrap-around rubber bumper
  - Top level with amenity box with lid and adjustable separators for convenient organization

- IT**
- 2 ripiani regolabili in altezza
  - Bordo paracolpo in gomma antitraccia
  - Ripiano superiore dotato di un porta oggetti con separatori regolabili.

- FR**
- 2 étagères ajustables
  - Pare-chocs intégral non-marquant
  - Cavité supérieure avec séparateurs ajustables pour l'organisation des produits d'accueil

- DE**
- 2 höhenverstellbare Einlegeböden
  - Nicht abfärbender rundum Gummistoßschutz
  - Oberste Etage mit integriertem Kleinartikellkasten mit variabler Inneneinteilung

Panel Finish

LAM



Options



	KG				Max size	Rooms	CODE
<b>GEORGE XL</b>	max. 150 Kg	4 swivel x Ø160 mm 'CMP', 2 of which with brake	Laminated wood Legno laminato Bois mélaminé Melaminharzbeschichtetes Holz	1430x 575x h1302 mm	1834x 575x h1302 mm	15 - 20	050105WD





**ALU MADE** IMPROVED AND PERFECT FOR OUTDOOR USE.

**MOQ**



- EN**
- 2 fixed shelves
  - Lockable aluminium doors
  - Non marking and full wrap-around rubber bumper

- IT**
- 2 ripiani fissi
  - Chiusura con porte munite di serratura
  - Bordo paracolpo in gomma antitraccia

- FR**
- 2 étagères fixes
  - Portes en aluminium verrouillables
  - Pare-chocs intégral non-marquant

- DE**
- 2 feste Einlegeböden
  - Abschließbare Türen
  - Nicht abfärbender rundum Gummistoßschutz



## DAKAR ALU KIT: Fully operational solutions

Basic model

Option PVC



+



Option SAC

**MOQ**



### Options

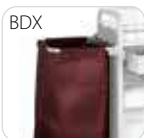

	max. 150 Kg	4 swivel Ø160 mm	Anodized aluminum Alluminio anodizzato Aluminium anodisé Eloxiertes Aluminium	890x 550x h1386 mm	Max size 1544x 550x h1386 mm	Rooms 9 - 12	48 Kg	CAD00117



NEW



- EN**
- Left interior side with pull out storage drawer for garbage and for linen
  - Extra drawer and compartments e.g. for cleaning products
  - Concealed sliding doors

- IT**
- Nel lato interno sinistro, un cassetto per raccolta rifiuti e biancheria
  - Cassetto extra e scompartimenti per prodotti di pulizia
  - Porte scorrevoli a scomparsa

- FR**
- Intérieur gauche: corbeille à déchets et à linge sale sur glissières
  - Tiroir supplémentaire et compartiment pour produits d'accueil et de nettoyage
  - Kit de portes rabattable à l'intérieur

- DE**
- Linke Innenraumseite mit Auszug für Müllsammel- und Wäschebehälter
  - Weitere Schublade sowie Fächer z.B. für Reinigungsmittel
  - Versenkbare Türe

### Options



### Panel Finish

LAM



LNO

LWE

LAN

LNE

LNV

LBE

LWS

LOM

LBV

LTR

LCO



- EN**
- 1 Linen bag on rails
  - 2 Left interior side with pull out storage drawer for garbage and for linen
  - 3 Extra drawer and compartments e.g. for cleaning products
  - 4 Concealed sliding doors
  - 5 Right interior side with 3 shelves, 2 drawers

- IT**
- 1 Sacco in poliestere su guide estraibili
  - 2 Nel lato interno sinistro cassetto per raccolta rifiuti e biancheria
  - 3 Cassetto extra e scompartimenti per prodotti di pulizia
  - 4 Porte scorrevoli a scomparsa
  - 5 Nel lato interno destro 3 ripiani e 2 cassetti

- FR**
- 1 Sac pour linge sale, sur glissières
  - 2 Intérieur gauche: Corbeille à déchet, sur glissière
  - 3 Tiroir supplémentaire et compartiment pour produits d'accueil et de nettoyage
  - 4 Kit de portes rabattable en intérieur
  - 5 Intérieur côté droit : 3 étagères et 2 tiroirs

- DE**
- 1 Auszug mit Wäschesack
  - 2 Auszug für Müllsack
  - 3 Weitere Schublade sowie Fächer z.B. für Reinigungsmittel
  - 4 Versenkbare Türen
  - 5 Rechte Innenraumseite mit 3 höhenverstellbare Einlegeböden und 2 Schubladen

<b>PALACE EASY</b>	max. 150 Kg	2 swivel and 2 fixed x Ø160 mm 'RNY'	Laminated wood Legno laminato Bois mélaminé Melaminharzbeschichtetes Holz	1080x 580x h1545 mm	Rooms 3 - 5	CAD00201



NEW



- EN**
- 2 adjustable shelves
  - Lockable plastic doors
  - 2 removable bags with zip
  - Auxiliary lower drawer
  - Top shelf with hedges
  - 4 donut bumpers







- IT**
- 2 ripiani regolabili
  - Chiusura con porte munite di serratura
  - 2 borse rimovibili con zip
  - Compartimento inferiore ausiliario
  - Ripiano superiore con protezione
  - 4 ruote paracolpo ricoperte di gomma antitraccia

- FR**
- 2 étagères réglables
  - Fermeture avec portes verrouillables
  - 2 sacs amovibles avec fermeture éclair
  - Niveau inférieur
  - Tablette supérieure avec protection
  - 4 pare-chocs en caoutchouc non marquant

- DE**
- 2 höhenverstellbare Einlegeböden
  - Abschließbare Kunststofftüren
  - 2 abnehmbare Taschen mit Reißverschluss
  - Zusätzliche untere Schublade
  - Oberes Regal mit Fallschutz
  - 4 Abweisrollen

**PLASTIC  
MADE**

**PERFECT FOR OUTDOOR USE.  
PERFETTO PER UN USO ALL'ESTERNO.  
IDÉAL POUR UTILISATION EXTÉRIEURE.  
PERFEKT FÜR DEN AUSSENEINSATZ.**

						
<b>CAPRI ECO</b>	max. 120 Kg	2 swivel and 2 fixed x Ø200 mm, 2 of which with brake	High-density polyethylene (HDPE) Polietilene ad alta densità (HDPE) Polyéthylène haute densité (PE-HD) Polyethylen hoher Dichte (HDPE)	1530x 550x h1270 mm	12 - 15	CAD00119.G



## HALLEY 2



HALLEY 2

- EN** • Lower full metal drawer
  - Upper liftable holder for linen bag incl. polyester bag of 127 Ltr.
- IT** • Cassetto inferiore in metallo
  - Supporto superiore per sacco biancheria completo di un sacco poliestere da 127 Ltr.
- FR** • Tiroir métallique inférieur
  - Support supérieur relevable avec sac 127 Ltr. en polyester inclus
- DE** • Untere Metall-Schublade
  - Obere klappbare Wäschesackhalterung inkl. Polyestersack 127Ltr. anthrazit

## PALACENET



PALACENET + OPT. BP

- EN** • 1 inner compartment with height adjustable shelf
  - Lockable roller shutter
- IT** • Scompartimento interno con ripiano regolabile in altezza
  - Chiusura a serranda con chiave
- FR** • 1 compartiment intérieur avec étagère amovible
  - Volet roulant verrouillable
- DE** • Oberste Ebene mit Schutzreling
  - Abschließbarer Rollo

### Options



### Panel Finish



\*=AVAILABLE ONLY FOR

				Max size	Max size	Rooms		CODE
<b>HALLEY 2 *</b>	max. 150 Kg	2 swivel x Ø150 mm and 2 fixed x Ø300 mm 'PNP'	Steel tubing structure with HPL panels Struttura in tubo d'acciaio con pannelli HPL	628x 540x h1433mm	628x 540x h1433mm	3 - 4	37 Kg	050401HPL
<b>PALACENET</b>		4 swivel x Ø150 mm 'CMP', 2 of which with brake	Structure en tubes d'acier avec panneaux HPL Stahlrohrrahmen mit HPL-Platten	690x 565x h1320 mm	1350x 565x h1320 mm		35 Kg	020100HPL



# IBIZA S / M / L



IBIZA M

- EN** • 2 height adjustable shelves  
 • Non marking and full wrap-around rubber bumper  
 • Double-sided upper liftable holders for waste bag and for polyester linen bag of 127 Ltr.

- IT** • 2 ripiani regolabili in altezza  
 • Bordo paracolpo in gomma antitraccia  
 • Supporto superiore pieghevole per sacco spazzatura in poliestere 127 Ltr. e sacco biancheria

- FR** • 2 étagères ajustables  
 • Pare-chocs intégral non-marquant  
 • Supports supérieurs pour sac poubelle et pour sac à linge 127 Ltr. en polyester

- DE** • 2 höhenverstellbare Einlegeböden  
 • Nach oben klappbare Müllsackhalterung  
 • Nach oben klappbare Wäschesackhalterung inkl. Polyestersack 127Ltr. anthrazit

## Options



## Panel Finish



					Max size	Rooms		
<b>IBIZA S</b>			Steel tubing structure with HPL panels	690x 566x h1491 mm	1334.5x 566x h1333 mm	7 - 10	31 Kg	050502HPL
<b>IBIZA M</b>	max. 150 Kg	4 swivel x Ø150 mm 'CMP'	Struttura in tubo d'acciaio con pannelli HPL Structure en tubes d'acier avec panneaux en HPL	890x 566x h1491mm	1535.5x 566x h1333 mm	10 - 13	38 Kg	050503HPL
<b>IBIZA L</b>			Stahlrohrrahmen mit HPL-Platten	1096x 566x h1491 mm	1755x 566x h1333 mm	13 - 16	46 Kg	050504HPL

## EASY

NEW



EASY

## SAMOA S / M

NEW



SAMOA M

- EN**
- 4 fixed shelves
  - Rubber ring buffers
  - 2 folding bag holders with fireproof bag and PVC (SAMOA)
  - 2 folding bag holders with canvas bag for dirty linen (EASY)









- FR**
- 4 étagères fixes
  - Pare-chocs
  - 2 supports supérieurs relevables avec sac en ignifuge et PVC sac (SAMOA)
  - 2 supports supérieurs relevables avec sac en toile (EASY)

- IT**
- 4 piani fissi
  - Paracolpi in gomma
  - 2 reggisacco pieghevoli con sacco ignifugo e PVC (SAMOA)
  - 2 portabiancheria in tela (EASY)

- DE**
- 4 feste Böden aus Melamin
  - Gummipuffer
  - 2 feuerfester Gewebesack inbegriffen (SAMOA)
  - 2 faltbeutelhalter mit 2 Baumwollsäcken (EASY)

## Options



						
<b>EASY</b>	4 swivel x Ø150 mm	Stainless steel square tube	810x 520x h1510 mm	1200x 520x h1370 mm	4 - 5	050405IN 
<b>SAMOA S</b>	4 swivel x Ø125 mm	Struttura in tubo d'acciaio quadrato	900 x 500x h1230 mm	1430 x 500x h1230 mm	2 - 4	CAD00229 
<b>SAMOA M</b>		Structure tube carré acier inoxydable Vierkantrohr Edelstahl	1100 x 500x h1230 mm	1430 x 500x h1230 mm	4 - 5	CAD00168 



## AMBIENTE

NEW



## TRANSNET

NEW



- EN**
- Made with 100% recycled plastic
  - Equipped by: 2 upper buckets 6 Ltr. each, 2 buckets of 20 Ltr. each and mop wringer, 2 bucket baskets
  - Bag holder with bag cover and broom holder on the sides

- IT**
- Realizzato con plastica 100% riciclata
  - Dotato di: 2 secchi superiori 6 Ltr. cad., 2 secchi da 20 Ltr. cad. e strizzatore mop, 2 cestelli portasecchi
  - Reggisacco con coprisacco e portascopo sui fianchi

- FR**
- Fabriqué en plastique 100% recyclé
  - Chariot équipé avec 2 seaux supérieurs de 6 Ltr. chacun, 2 seaux inférieurs de 20 Ltr. chacun, 2 paniers porte-seaux, 1 essoreur
  - Support pour sac avec sac de cache et clip à balais

- DE**
- Aus 100% recycelbarem Kunststoff
  - Ausgestattet mit 2 Eimer je 6 Ltr., 2 Eimer je 20 Ltr. und Wringer
  - Mülleimerhalterung mit Deckel, Sichtschuttsack und Besenhalter

- EN**
- Chrome plated folding trolley, equipped with 2 bucket with wringer for mop
  - Equipped with broom clip
  - 1 red nylon bag 120 Ltr.

- IT**
- Carrello pieghevole completo di 2 secchi di cui uno con strizzatore per mop
  - Dotato di portamanico in gomma
  - Sacco in nylon rosso da 120 Ltr.

- FR**
- Chariot pliable équipé avec 2 seaux dont un avec essoreur
  - 1 clip à balais
  - 1 sac en nylon rouge 120 Ltr.

- DE**
- Verchromter und faltbarer Reinigungswagen, mit 2 Eimern und 1 Wringer
  - Ausgestattet mit Besenclip
  - 1 rote Nylontasche 120 Ltr.

<b>AMBIENTE</b>	4 swivel x Ø 80 mm	Steel tube and recycled plastic Struttura in tubo d'acciaio e plastica riciclata Tubes en acier chromé et plastique recyclé Stahlrohr verchromt und Kunststoff	930x 670x h1100 mm	14,8 Kg	CAD00228
<b>TRANSNET</b>		Chromed steel tube Struttura in tubo d'acciaio cromato Tubes en acier chromé Stahlrohr verchromt und Kunststoff	900x 510x h1000 mm	15 Kg	CAD00226





## PLASNET



- EN** • Upper basket with support clip for brooms  
• 2 buckets 15 Ltr. 1 wringer and 2 buckets 6 Ltr.

- IT** • Cestello superiore con clip per le scope  
• 2 secchi da 15 Ltr. ciascuno, 1 strizzatore e 2 secchi da 6 Ltr.

- FR** • Panier supérieur avec support clip pour balais  
• 2 seaux de 15 Ltr. 1 essoreur et 2 seaux de 6 Ltr.

- DE** • Mülleimerhalterung mit Deckel und Besenhalter  
• 2 Eimer 15 Ltr, 1 Wringer und 2 Eimer à 6 Ltr.

## FLOOR SAFETY SIGN



- EN** • Plastic floor sign with double side imprint  
• Dimensions: 300x h700 mm

- IT** • Pannello segnalatore completo di 2 dischi segnaletici  
• Dimensioni: 300x h700 mm

- FR** • Panneau sol mouillé  
• Dimensions: 300x h700 mm

- DE** • Bodenschild mit 2-seitigem Aufdruck in englisch  
• Maße: 300x h700 mm

					
<b>PLASNET</b>	4 swivel x Ø 100 mm with donut bumpers	Chromed steel tube Struttura in tubo d'acciaio cromata Tubes en acier chromé Stahlrohr verchromt und Kunststoff	1000 x 540 x h1150 mm	16,6 Kg	CAD00059 
<b>FLOOR SAFETY SIGN</b>	-	Plastic Plastica Plastique Kunststoff	-	1,4 Kg	CAD00039 



caddie





# LAUNDRY SERVICE

**EN Our know-how** in the development of transport and mobile storage carts and containers is based on ground experience. The outcome is a set of equipment featuring an easy and ergonomic handling style when fully loaded.

**IT La nostra abilità** nella creazione di carrelli e contenitori per il trasporto e lo stoccaggio della biancheria è data da anni di prove e test sul campo. Risultato: una gamma di prodotti maneggevoli ed ergonomici anche a pieno carico!

**FR Notre savoir-faire** dans le développement de chariots et containers de transport et stockage de linge est basé sur de nombreux essais et une mise en situation des produits. Résultat: un équipement combinant facilité de manœuvre et ergonomie, même chargé au maximum!

**DE Damit kennen wir uns aus:** Praxiserprobt und –bewährt sind unsere verschiedenen Transport- und Lagerbehälter, die selbst im beladenen Zustand leicht zu handhaben sind.



## CADDIE SAC

## CADDIE SAC HYDRO



CADDIE SAC



CADDIE SAC HYDRO

- EN** • Lower platform with metal bars  
 • Detachable laundry bag in polyester (CADDIE SAC) or a durable water repellent bag in burgundy (CADDIE SAC HYDRO)

- IT** • Piattaforma inferiore con barre di metallo  
 • Sacco biancheria amovibile, disponibile in 2 versioni: sacco in poliestere grigio (CADDIE SAC) o sacco idrorepellente bordeaux (CADDIE SAC HYDRO)

- FR** • Structure support inférieure anti-affaissement  
 • Sac détachable et lavable en Polyester (CADDIE SAC) ou en mix Polyester-nylon imperméable bordeaux (CADDIE SAC HYDRO)

- DE** • Stabile untere Ablage aus Metallstreben  
 • Abnehmbarer, waschbarer Wäschesack in grauem Polyester (CADDIE SAC), oder mit wasserabweisender, bordeauxroter Wäschesack (CADDIE SAC HYDRO)

<b>CADDIE SAC</b>	192 Ltr.	4 swivel x Ø125 mm "TPP" with donut bumpers, 2 of which with brake	Steel tube with grey powder coating Struttura in tubo d'acciaio verniciato color grigio	1030x 535x h922,5 mm	13 Kg	060100LN
<b>CADDIE SAC HYDRO</b>			Structure tubes d'acier peint gris clair Vierkant-Stahlrohr, pulverbeschichtet in grau			060100BDX

## CADDIE SAC XS



CADDIE SAC XS

## CADDIE SAC HYDRO XS









CADDIE SAC HYDRO XS

- EN** • Lower platform with metal bars  
 • Detachable laundry bag in polyester (CADDIE SAC XS) or a durable water repellent bag in burgundy (CADDIE SAC HYDRO XS)

- IT** • Piattaforma inferiore e barre di metallo  
 • Sacco biancheria amovibile, disponibile in 2 versioni: sacco in poliestere grigio, (CADDIE SAC XS) o sacco idrorepellente bordeaux (CADDIE SAC HYDRO XS)

- FR** • Structure support inférieur anti-affaissement  
 • Sac détachable et lavable en Polyester (CADDIE SAC XS) ou en mix Polyester-nylon imperméable bordeaux (CADDIE SAC HYDRO XS)

- DE** • Stabile untere Ablage aus Metallstreben  
 • Abnehmbarer, waschbarer Wäschesack in grauem Polyester (CADDIE SAC XS), oder mit wasserabweisender, bordeauxroter Wäschesack (CADDIE SAC HYDRO XS)  
 • 4 Abweisinge

						
<b>CADDIE SAC XS</b>	150 Ltr.	4 swivel x Ø125 mm 'TPP' with donut bumpers, 2 of which with brake	Steel tube with grey powder coating Struttura in tubo d'acciaio verniciato color grigio	747,7x 535x h922,5 mm	12 Kg	060100LN XS
<b>CADDIE SAC HYDRO XS</b>			Vierkant-Stahlrohr, pulverbeschichtet in grau			060100BDX XS



## IBIZA TRISAC 2

## CADDIE X 2



IBIZA TRISAC 2



CADDIE X 2

- EN**
- Lower platform with metal bars for IBIZA TRISAC 2
  - Lower PVC straps support for CADDIE X and CADDIE X 2
  - Polyester bags included
  - 4 swivel wheels

- FR**
- Cadre support inférieur avec traverses métalliques anti-affaissement pour IBIZA TRISAC 2
  - Support inférieur en sangles en PVC pour CADDIE X 2
  - Sacs à linge polyester inclus
  - 4 roulettes pivotantes

- IT**
- Piattaforma inferiore con barre di metallo IBIZA TRISAC 2
  - Cinghie inferiori in PVC di supporto per CADDIE X 2
  - Sacchi in poliestere inclusi
  - 4 ruote girevoli

- DE**
- Stabile untere Ablage aus Metallstreben zum IBIZA TRISAC 2
  - Stabile untere Ablage zum CADDIE X und CADDIE X 2
  - Inkl. grauen Polyestersäcken
  - 4 lenkroller

						
<b>IBIZA TRISAC 2</b>	2 x 127 Ltr.	4 swivel x Ø 125 mm with donut bumpers	Steel tube with grey powder coating RAL 9006 Struttura in tubo d'acciaio verniciato color grigio RAL 9006	755.6x 465x h1062.5 mm	12 Kg	060502IB
<b>CADDIE X 2</b>	300 Ltr.	4 swivel x Ø 125 mm, with donut bumper 2 of which with brake	Structure en tube d'acier peint gris clair RAL9006 Vierkant-Stahlrohr, pulverbeschichtet in RAL 9006 (grau)	920x 485x h1050 mm	10,5 Kg	060102LN

**NEW**

## CADDIE X

## CADDIE X ECO

NEW



CADDIE X









CADDIE X ECO

- EN** • Lower platform in folding wire and cotton bag included (CADDIE X ECO)
- Polyester bags included (CADDIE X)
  - Including Lower PVC straps support (CADDIE X)

- IT** • Piattaforma inferiore in filo pieghevole e sacco cotone sanforizzato incluso (CADDIE X ECO)
- Saccho in poliestere incluso (CADDIE X)
  - Cinghie inferiori in PVC di supporto (CADDIE X)

- FR** • Support inférieur anti-affaissement en fils d'acier et inclut un sac à linge en coton (CADDIE X ECO)
- Sac à linge polyester inclu (CADDIE X)
  - Support inférieur en sangles en PVC (CADDIE X)

- DE** • Stabile untere Ablage und inkl. grauem Baumwollsack (CADDIE X ECO)
- Stabile untere Ablage zum (CADDIE X)
  - Inkl. grauen Polyestersäcken (CADDIE X)

						
<b>CADDIE X</b>	150 Ltr.	4 swivel x Ø80 mm with donut bumper	Steel tube with grey powder coating RAL 9006 Struttura in tubo d'acciaio verniciato color grigio RAL 9006 Structure en tube d'acier peint gris clair RAL9006 Vierkant-Stahlrohr, pulverbeschichtet in RAL 9006 (grau)	500x 485x h1050 mm	6,5 Kg	060101LN
<b>CADDIE X ECO</b>	230 Ltr.	4 swivel x Ø80 mm with donut bumper	Stainless steel Acciaio inox Acier inoxydable Edelstahl	530x 500x h1040 mm	6,5 Kg	CAD00227 



# TRISAC 1 / 2 / 3 / 4



TRISAC 1



TRISAC 4

- EN** • Lower platform with metal bars  
 • 1, 2, 3 or 4 detachable polyester bags  
 • Black plastic lid for each laundry bag

- IT** • Piattaforma inferiore con barre di metallo  
 • 1, 2, 3 o 4 sacchi in poliestere amovibili  
 • Coperchio nero in plastica per ogni sacco

- FR** • Structure support inférieure avec traverses métalliques anti-affaissement  
 • 1, 2, 3 ou 4 sacs polyester amovibles inclus  
 • Couverture en plastique noir pour chaque sac

- DE** • Stabile untere Ablage aus Metallstreben  
 • 1, 2, 3 oder 4 abnehmbare Polyestersäcke  
 • Schwarze Plastikdeckel

<b>TRISAC 1</b>	<b>BIGGER BAG</b> 127 Ltr.	4 swivel x Ø125 mm with donut bumpers, 2 of which with brake	Steel tube with grey powder coating RAL 9006 Struttura in tubo d'acciaio verniciato color grigio RAL 9006 Structure en tube d'acier peint gris clair RAL9006 Stahlrohr, pulverbeschichtet RAL 9006	426x 465x h1077,5 mm	9 Kg	060201LN
<b>TRISAC 2</b>	<b>BIGGER BAGS</b> 2 x 127 Ltr.			756x 465x h1077,5 mm	12 Kg	060202LN
<b>TRISAC 3</b>	<b>BIGGER BAGS</b> 3 x 127 Ltr.			1036x 465x h1077,5 mm	15 Kg	060203LN
<b>TRISAC 4</b>	<b>BIGGER BAG</b> 4 x 127 Ltr.			1340,6x 465x h1077,5 mm	18 Kg	060204LN

**NEW**





TRISAC ALU 1



TRISAC ALU 3

- EN**
- White ABS bottom base
  - 1, 2, 3 or 4 moduls with detachable, anthracite polyester bags
  - Bracket clip for an easy fixation of the bags
  - Colored plastic lid for each laundry bag

- IT**
- Base bianca in ABS
  - Da 1 a 4 moduli con sacco amovibile grigio in poliestere
  - Clip per un comodo fissaggio dei sacchi
  - Coperchio in plastica colorata per ogni sacco

- FR**
- Base blanche en ABS
  - 1, 2, 3 ou 4 sacs polyester anthracite
  - Mise en place des sacs grâce à la fixation par anneau extérieur
  - Couvercle en plastique teinté pour chaque sac

- DE**
- ABS-Bodenplatte weiß lackiert
  - Inkl. 1, 2, 3 oder 4 abnehmbaren, grauen Polyestersäcken
  - Leichte Fixierung der Säcke durch Klemmbügel
  - Farbige Kunststoffdeckel

<b>TRISAC ALU 1</b>	87 Ltr.	4 swivel x Ø75 mm 'CMM', 2 of which with brake	Anodized aluminium tube frame, white ABS steel bottom base Struttura in tubo d'alluminio anodizzato con base bianca in ABS Structure en alliage léger anodisé, base en ABS Eloxiertes Aluminium, Bodenplatte aus Stahlblech weiß lackiert	390x 410x h880 mm	9 Kg	060301LN
<b>TRISAC ALU 2</b>	2 x 87 Ltr.			790x 410x h880 mm	16 Kg	060302LN
<b>TRISAC ALU 3</b>	3 x 87 Ltr.			1190x 410x h880 mm	19 Kg	060303LN
<b>TRISAC ALU 4</b>	4 x 87 Ltr.			1575x 410x h880 mm	23 Kg	060304LN



# SIRIO / CESTO



SIRIO



CESTO

- EN**
- 4 swivel wheels
  - Stackable
  - Fully welded structure

- IT**
- 4 ruote girevoli
  - Impilabile
  - Struttura completamente saldata

- FR**
- 4 roulettes pivotantes
  - Empilable
  - Structure entièrement soudée

- DE**
- 4 lenkroller
  - Stapelbar
  - Vollverschweißte Konstruktion

## Options



Options only available for the products marked with '\*'  
 Opzionale disponibile solo per i prodotti segnati con '\*'  
 Options seulement disponibles pour les produits désignés par '\*'  
 Optionen nur für die mit \* markierten Modelle

<b>SIRIO*</b>	max. 250 Kg	4 swivel x Ø100 mm 'CMM'	Steel wire structure electrolytically galvanized with white powder coating Struttura in tubo d'acciaio elettro galvanizzata con verniciatura bianca Structure en fils d'acier soudée avec revêtement epoxy blanc anti-corrosion Verzinkter Drahtwagen, weiß pulverbeschichtet	840x 630x h750 mm	270 Ltr.	14 Kg	99405750
<b>CESTO</b>	max. 400 Kg	4 swivel x Ø125 mm	Steel tube frame with wire mesh, electrolytically galvanized Struttura in tubo e filo d'acciaio. Finitura: zincatura brillante Tubes et fils d'acier, finition électro-galvanisée Rohr- und Drahtkonstruktion, elektrolytisch verzinkt	810x 610x h740 mm		17,5 Kg	CEST001

## BACTAINER ALU / S/L



BACTAINER ALU S/L



BACTAINER ALU









- EN**
- Upper rim reinforced
  - Water-tight bottom plate
  - Perforated and removable double base with integrated drain tap (ALU)
  - Mobile spring driven self-leveling base that moves according to the weight (ALU S/L)

- IT**
- Bordo superiore rinforzato
  - Base inferiore a tenuta stagna
  - Doppio fondo forato e rimovibile con tappo di scarico (ALU)
  - Fondo mobile montato su molle che si regolano in base al peso caricato (ALU S/L)

- FR**
- Bord supérieur arrondi et renforcé rond étanche
  - Grille de fond amovible perforée et bonde de vidange (ALU)
  - Fond mobile à niveau constant monté sur ressort (ALU S/L)

- DE**
- Oberer Rand verstärkt
  - Wasserdichter Boden
  - Gelöcherter und abnehmbarer Doppelboden (ALU)
  - Integrierter Ablaufhahn (ALU)
  - Mobiler Federboden, der sich je nach Belastung senkt oder hebt für leichteres Be- und Entladen (ALU S/L)

							
<b>BACTAINER ALU S/L</b>	max. 70 Kg	2 swivel and 2 fixed x Ø125 mm	Anodized aluminium Struttura in alluminio anodizzato	1080x 630x 800 mm	336 Ltr.	51 Kg	070201AL
<b>BACTAINER ALU</b>	max. 150 kg	2 swivel and 2 fixed x Ø200 mm	Aluminium anodisé Eloxiertes Aluminium	1030x 630x h735 mm	270 Ltr.	32 Kg	070202AL



## BACTAINER 180 L

## BACTAINER 360 L



BACTAINER 180 L









BACTAINER 360 L

- EN**
- Removable lid with 2 foldable flaps
  - Integrated drain tap (3/4 inch)
  - Stackable

- IT**
- Coperchio amovibile con 2 alette pieghevoli
  - Tappo per lo scarico incluso
  - Impilabile

- FR**
- Couvercle amovible et articulé sur une charnière inox
  - Bonde de vidange
  - Empilable

- DE**
- Abnehmbarer Deckel mit 1/2 Öffnung
  - Mit integriertem Ablaufhahn (3/4 Zoll)
  - Stapelbar

							
<b>BACTAINER 180 L</b>	max. 200 kg	2 swivel and 2 fixed x Ø100 mm	White polypropylene Polipropilene bianco Polypropylène blanc	600x 440x h690 mm	180 Ltr.	15 Kg	070101PE
<b>BACTAINER 360 L</b>	max. 400 kg	2 swivel and 2 fixed x Ø150 mm	Polypropylen weiß, lebensmittelecht	950x570x h820 m	360 Ltr.	34 kg	070102PE

## MOBILINGE



MOBILINGE

- EN** • Blue plastic roll down curtain with velcro fasteners  
• 2 shelves, folding down at 90° angle for multipurpose use

- IT** • Telo di chiusura in plastica blu con fascette in velcro  
• 2 ripiani ribaltabili a 90°

- FR** • Rideau déroulant bleu en plastique avec fermeture vélcro  
• 1 étagère relevable et 1 rabattable à 90° pour usage polyvalent

- DE** • Blaue Verschlussabdeckung aus Kunststoff mit Klettverschluss  
• 2 Einlegeböden um 90° abklappbar für leichtes Handling

						
<b>MOBILINGE</b>	max. 135 Kg	2 swivel and 2 fixed x Ø125 mm	Anodized aluminium Struttura in lega leggera ossidata anodicamente Aluminium anodisé Eloxiertes Aluminium	800x 600x h1650 mm	48 Kg	070203AL



# MOBILINGE M / L



MOBILINGE M







MOBILINGE L

- EN**
- Non-marking and full wrap-around rubber bumper
  - 2 fixed shelves
  - 2 doors with magnetic latches opening at 270°
  - Pushing handle

- FR**
- Pare-chocs périmétrique non marquant
  - 2 étagères fixes
  - 2 portes ouvrant à 270° avec poignées verrous
  - Poignée de poussée

- IT**
- Paracolpo integrale anti-traccia
  - 2 ripiani interni fissi
  - 2 porte con chiusura magnetica ed apertura a 270°
  - Maniglione di spinta

- DE**
- Nicht abfärbender, rundum Gummistoßschutz
  - 2 feste Regale
  - 2 Türen mit seitlicher Magnethaftung, Öffnungswinkel 270°
  - Mit Schiebegriff

						
<b>MOBILINGE M</b>	max. 250 Kg	2 swivel and 2 fixed x Ø200 mm	Anodized aluminium Struttura in lega leggera ossidata anodicamente	1230x 630x h1500 mm	66 Kg	070204AL
<b>MOBILINGE L</b>			Aluminium anodisé Eloxiertes Aluminium	1230x 630x h1740 mm	70 Kg	070205AL

# ROLL BASE / 3 / 4

**NEW**



ROLL BASE

**NEW**



ROLL BASE 3

**NEW**



ROLL BASE 4

- EN** • 2 (BASE) or 3 removable sides panels (BASE 3/4) including a labeling space  
 • Mesh dimensions: 45x180 mm (base); 106x405 mm (side)

- IT** • Roll container a due (BASE) o a tre lati (BASE 3/4) con pannelli laterali amovibili, include placca porta-etichette  
 • Dimensioni maglia: 45x180 mm (base) / 106x405 mm (pannello)

- FR** • 2 (BASE) ou 3 panneaux démontables (BASE 3/4) avec plaque d'identification  
 • Maille : 45x180 mm (socle) / 106x405 mm (panneaux latéraux)

- DE** • Rollcontainer mit 2 Seiten (BASE) / mit 3 geschlossenen Seiten (BASE 3/4) und abklappbarer Fronttür (BASE 4)  
 • Seitenteile herausnehmbar 2 Seitenwände mit Beschriftungsplatte  
 • Basis-/Seitenmaschenweite: 45x180 mm / 106x405 mm

## Options

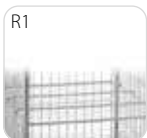

<b>ROLL BASE</b>	max. 500 Kg	2 swivel and 2 fixed x Ø125 mm	Steel tube frame with wire mesh, electrolytically galvanized	715x 805x h1800 mm	22 Kg	Disassembled product	ROLL001
<b>ROLL BASE 3</b>			Finitura: zincatura brillante		27 Kg	Prodotto smontato	ROLL002
<b>ROLL BASE 4</b>			Rohr- und Drahtkonstruktion, elektrolytisch verzinkt		34,5 Kg	Produit démonté	ROLL003



# ROLL SICUREZZA 1 / 2

**NEW**



ROLL SICUREZZA 1

**NEW**



ROLL SICUREZZA 2

- EN**
- Top panel
  - Door/s can be padlocked (not included)
  - 1 full-height door opening at 270° (1)
  - 2 half doors opening at 270° (2)
  - Mesh dimensions: 45x180 mm (base); 50x50mm (side)

- IT**
- Pannello superiore
  - Possibilità di chiusura porte con lucchetto (non incluso)
  - 1 porta con apertura a 270° (1)
  - 2 mezze porte con apertura a 270° (2)
  - Dimensioni maglia: 45x180 mm (base) / 50x50 mm (pannelli laterali)

- FR**
- Panneau de fermeture supérieur
  - Porte/s verrouillable/s avec cadenas (non-fourni)
  - 1 grande porte s'ouvrant à 270° (1)
  - 2 demies-portes s'ouvrant à 270° (2)
  - Maille: 45x180 mm (socle) / 50x50 mm (panneaux latéraux)

- DE**
- Komplett geschlossener Rollcontainer mit Deckel
  - Abschließbare Tür/en für Vorhängeschloss geeignet (Schloss nicht enthalten)
  - 1 große Tür, Öffnungswinkel 270° (1)
  - Horizontal geteilte Tür, Öffnungswinkel 270° (2)
  - Basis-/Seitenmaschenweite: 45x180mm / 50x5 mm

**Options**

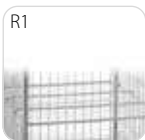

<b>ROLL SICUREZZA 1</b>	max. 500 Kg	2 swivel and 2 fixed x Ø125 mm	Steel tube frame with wire mesh, electrolytically galvanized Struttura in tubo e filo d'acciaio. Finitura: zincatura brillante Tubes et fils d'acier, finition électro-galvanisée	700x 800x h1800 mm	45 Kg	Disassembled product Prodotto smontato Produit démonté	ROLLS11
<b>ROLL SICUREZZA 2</b>			Rohr- und Drahtkonstruktion, elektrolytisch verzinkt		46 Kg	Demontiertes Produkt	ROLLS12



## STENDER EASY / STENDER EASY HR / STENDER BASE Z



STENDER EASY



STENDER EASY HR







STENDER BASE Z

- EN**
- Bilateral extension bars (EASY)
  - Holds 30 - 35 garments on hangers
  - Removable structure (HR)
  - Available with optional hat rack (HR)
  - Nestable (BASE Z)

- FR**
- 2 extensions latérales (EASY)
  - Capacité 30 - 35 cintres
  - Structure amovible (HR)
  - Disponible avec porte-chapeau (HR)
  - Emboîtable (BASE Z)

- IT**
- Barre estendibili su entrambi i lati (EASY)
  - Possibilità di appendere fino a 30 - 35 capi
  - Struttura smontabile (HR)
  - Disponibile anche con l'opzione cappelliera (HR)
  - Impilabile (BASE Z)

- DE**
- Beidseitige Ausziehelemente an oberem Holm (EASY)
  - Platz für ca. 30 - 35 Jacken auf Bügeln
  - Mit Hutablage (HR)
  - Abnehmbare Struktur (HR)
  - Platzsparend ineinanderschiebbar (BASE Z)

					
<b>STENDER EASY</b>	80 Kg	4 swivel x Ø80 mm	Steel with chrome finish Tubo d'acciaio cromato Tubes acier chromé Stahlrohr verchromt	1549/2001x 557x h1562 mm	040201CR
<b>STENDER EASY HR</b>		4 swivel x Ø45 mm		1500x 550x h1720 mm	040202CR
<b>STENDER BASE Z</b>	70 Kg	4 swivel x Ø80 mm with donut bumpers, 2 of which with brake	Steel tube frame, lower part powder coated Telaio in tubo d'acciaio verniciato con parte superiore cromata Bâti en tube acier peinte. Structure en tubes d'acier verni, partie supérieure chromée Fahrgestell aus Stahl mit grauer Pulverbeschichtung, Kleiderstange verchromt	1140x 600x h1150 mm	STENBAZ





# ROOM SERVICE

**EN As practical as beautiful:** our range for the specific needs of a perfect room-service delivery includes room-service tables, minibar trolleys and service carts.

**IT Tanto pratico quanto elegante:** la nostra gamma di prodotti per un perfetto servizio in camera comprende tavolini, carrelli rifornimento minibar e carrelli di servizio.

**FR Aussi pratique qu'élégant:** notre gamme de produits pour un room service parfait inclut des tables, des chariots de réapprovisionnement de minibar ainsi que des chariots de service en chambre.

**DE Praktisch und funktionell geht auch formschön:** zu unserem Programm für die spezifischen Anforderungen an einen perfekten Roomservice zählen stilvolle Serviertische, Minibar- sowie Servierwagen.



1

## Trendie bar



EN Turn-down service bag with removable drawer.

IT Borsa per il servizio in camera con cassetto estraibile.

FR Sac de service en chambre avec tiroir amovible.

DE Zimmerservice-Tasche mit herausnehmbarer Schublade.

+

2

## Handie bar



EN Room service trolley with waterproof pockets and perforated foam bottle holders.

IT Carrello per servizio in camera con tasche impermeabili e portabottiglie in schiuma perforata.

FR Chariot mini bar avec poches étanches et porte-bouteilles en mousse perforée.

DE Kompakter Zimmer-und Barservicewagen mit vielen wasserdichten Taschen sowie Schubladen mit einem extra Schaumstoff-Einsatz für Flaschen.

=

3

## Buddie bar



EN A complete set of 2 separate elements brought together for an impeccable and efficient invisible room and bar service.

IT Carrello composto di 2 separati elementi riuniti per un servizio in camera e bar invisibile ed efficiente.

FR Un ensemble comprenant le TRENDIE et le HANDIE, réunis pour un service mini bar efficace et invisible.

DE Die Kombination aus 2 separaten Elementen sorgt für ein unsichtbares und gleichzeitig effizientes House-Keeping.

# The caddiebar



1



3



- EN 1** Removable and washable inner plastic waste-pocket for excellent hygiene
- 2** Rigid plastic drawer with inner adjustable velcro dividers, keeping amenities and items well organized. Dividers can be removed and the Caddie can be washed and rinsed with water.
- 3** Rigid support with perforated foam.

- IT 1** Tasca interna in plastica portarifiuti rimovibile e lavabile per un'igiene senza impeccabile.
- 2** Cassetti con divisori interni regolabili in velcro che possono essere rimossi e il carrello può essere lavato e sciacquato con acqua.
- 3** Supporto rigido con schiuma perforata.

- FR 1** Poche-poubelle intérieure en plastique amovible et lavable pour une excellente hygiène.
- 2** Casier en plastique rigide avec séparateurs en velcro réglables. Les séparateurs sont amovibles et lavables à l'eau.
- 3** Support en mousse perforée. La mousse ne peut pas être retirée.

- DE 1** Absolut hygienisch: Viele Taschen und Innenelemente sind herausnehmbar und komplett waschbar. Mit Aufsteckband zum Fixieren am Handle.
- 2** Die festen Schubladen sind komplett entnehmbar. Sie verfügen über ein Trennwandsystem auf Klettverschlussbasis, das abnehmbar sowie waschbar ist.
- 3** Schaumstoff-Einsatz mit Flaschenaussparung.



**Available colours**



RE - Red BR - Brown BL - Blue BK - Black RAL 15 pieces MOQ.

XX=\*CODE COLOR  
COD. COLORE  
CODE COULEUR  
FARB CODE

<b>TRENDIE bar</b>	max. 10/15 Kg	-	PVCP (Hydrorepellent PVC-coated Polyester 600)	450x 380x h270 mm	4 Kg	CAD00083XX*
<b>HANDIE bar</b>	max. 25/30 Kg	2 x Ø 110 mm 2 x Ø 50 mm	PVCP (poliestere 600 idrorepellente rivestito in PVC)	450x 380x h620 mm	10 Kg	CAD00084XX*
<b>BUDDIE bar</b>	max. 35/45 Kg	2 x Ø 110 mm 2 x Ø 50 mm	Wasserdichtes PVC-beschichtetes Polyester 600	450x 380x h890 mm	14 Kg	CAD00085XX*



NEW

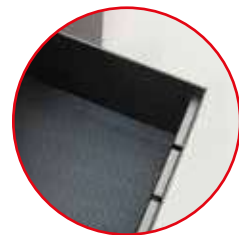

Options



<b>B-PALACE EASY</b>	max. 150 Kg	4 swivel x Ø160 mm	Laminated wood structure Struttura in legno laminato Bois mélaminé Melaminharzbeschichtetes Holz	850x 535x h1270 mm	70 Kg	CAD00252



- EN**
- 1 Laminated wood structure
  - 2 3 inner drawers with compartments
  - 3 1 shelf
  - 4 Small items box with lockable lid
  - 5 Lockable doors
  - 6 4 swivels castors Ø160 mm with 5th wheel

- IT**
- 1 Struttura in legno laminato
  - 2 3 cassetti interni con separatori
  - 3 1 ripiano
  - 4 Scompartimento superiore con coperchio e serratura
  - 5 Chiusura porte con chiave
  - 6 4 ruote girevoli Ø160mm e RS5 di serie

- FR**
- 1 Structure en bois mélaminé
  - 2 3 tiroirs intérieurs avec compartiments
  - 3 1 étagère
  - 4 Cavité supérieure avec couvercle métallique
  - 5 Kit de portes verouillables
  - 6 4 roulettes pivotantes Ø160 mm avec 5ème roue centrale

- DE**
- 1 Korpus aus laminiertem Holz
  - 2 3 innenliegende Schubladen mit Trennstegen
  - 3 1 Etage
  - 4 Kleinartikelkasten mit abschließbarem Deckel
  - 5 Abschließbare Flügeltüren
  - 6 4 Lenkrollen Ø160 mm 'RNY' sowie eine zusätzliche 5te Rolle 'RS5' zur besseren Manövrierbarkeit im beladenen Zustand

### Panel Finish

#### LAM





IBIZA BAR M

- EN**
- 3 shelves with metal retaining bars, 2 of which height-adjustable
  - 1 metal drawer with separators made of HPL (2 pcs. for M, 3 pcs. for L) maximum storage height 13,5 cm
  - Non marking and full wrap-around rubber bumper

- FR**
- 3 étagères avec barres métalliques de retenue dont ajustables
  - 1 tiroir en métal avec séparateurs ajustables HPL (taille M: 2, taille L: 3). Hauteur maximale de stockage : 13,5 cm
  - Pare-chocs intégral non marquant

- IT**
- 3 ripiani con spondine di protezione, di cui 2 regolabili in altezza
  - 1 cassetto in metallo con separatori in HPL (mod. M= 2 pz., mod. L= 3pz), altezza massima di stoccaggio 13,5 cm
  - Bordo paracolpo in gomma antitraccia

- DE**
- 3 Ebenen mit Schutzreling, davon 2 höhenverstellbar
  - 1 Metallschublade mit variabler Inneneinteilung aus HPL (M= 2 Stk., L= 3 Stk.), max. Höhe 13,5 cm
  - Oberste Ebene mit Aufkantung als Abrutschschutz
  - Nicht abfärbender rundum Gummistoßschutz

### Options



### Panel Finish



<b>IBIZA BAR M</b>	max. 150 Kg	4 swivel x Ø150 mm 'CMP'	Steel tubing structure with HPL panels Struttura in tubo verniciato con pannelli HPL	890x 566x h1333 mm	40 Kg	080503HPL
<b>IBIZA BAR L</b>			Structure en tubes d'acier avec panneaux en HPL Stahlrohrrahmen grau pulverbeschichtet, HPL-Platten	1096x 566x h1333 mm	46 Kg	080504HPL



## BORA-BORA M / L



BORA-BORA L

- EN** • Non marking and full wrap-around rubber bumper
- 3 metal drawers with separators made of HPL (2 pcs. for M, 3 pcs. for L); storage height: top 24 cm, middle 27 cm, bottom 27 cm
  - Standard 5th wheel

- IT** • Bordo paracolpo in gomma antitraccia
- 3 cassetti interni in metallo con separatori in HPL (mod. M= 2 pz., mod. L= 3 pz.): superiore 24 cm, centrale 27 cm, inferiore 27 cm
  - RS5 di serie

- FR** • Pare-chocs intégral non-marquant
- 3 tiroirs en métal avec séparateurs ajustables HPL (taille M: 2, taille L: 3); hauteur de stockage des tiroirs: haut 24 cm, milieu 27 cm, bas 27 cm
  - 5ème roue centrale

- DE** • 3 Metallschubladen mit variabler Inneneinteilung aus HPL (M = 2 Stk., L = 3 Stk.); Stellhöhen in Schubladen: Oben 24 cm, Mitte 27 cm, Unten 27 cm
- Nicht abfärbender rundum Gummistoßschutz
  - 5te Rolle 'RS5' zur besseren Manövrierbarkeit im beladenen Zustand

## Options



## Panel Finish



<b>BORA-BORA M</b>	max. 150 Kg	4 swivel x Ø150 mm 'CMP', 2 of which with brake + RS5	Steel tubing structure with HPL panels Struttura in tubo verniciato con pannelli HPL	890x 566x h1333 mm	54 Kg	080203HPL
<b>BORA-BORA L</b>			Structure en tubes d'acier avec panneaux en HPL Stahlrohrrahmen grau pulverbeschichtet, HPL-Platten	1096x 566x h1333 mm	60 Kg	080204HPL

# CHARLOTTE M / L



CHARLOTTE M + LID

- EN** • 3 metal drawers with separators; storage height: top 14 cm, middle 24 cm, bottom 28 cm, base shelf 30 cm
- With pushing handle

- IT** • 3 cassetti interni in metallo con separatori HPL: superiore 14 cm, centrale 24 cm, inferiore 28 cm, base carrello 30 cm
- Maniglione di spinta

- FR** • 3 tiroirs en métal avec séparateurs ajustables HPL. Hauteur des tiroirs: haut 14 cm, milieu 24 cm, bas 28 cm, étagère du bas 30 cm
- Poignée de poussée

- DE** • 3 Metallschubladen mit verstellbarer Inneneinteilung; Stellhöhen in Schubladen: Oben 14 cm, Mitte 24 cm, Unten 28 cm, Boden 30 cm
- Mit Schiebegriff

## Options



## Panel Finish

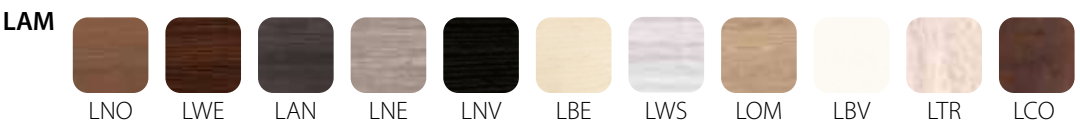

<b>CHARLOTTE M</b>	max. 150 Kg	4 swivel x Ø150 mm 'CMP', 2 of which with brake + RS5	Laminated wood structure Struttura in legno laminato Bois mélaminé Melaminharzbeschichtetes Holz	850x 535x h1270 mm	65 Kg	080103WD
<b>CHARLOTTE L</b>				1030x 535x h1270 mm	70 Kg	080104WD

## BALI BAR

NEW



- EN** • 4 metal drawers with separators; storage height: top 11.5 cm, middle 14.5 cm, middle 24.5 cm, bottom 31 cm
- 4 donut bumpers
  - Double pushing handle
  - 5th wheel included

- FR** • 4 tiroirs en métal avec séparateurs ajustables HPL. Hauteur des tiroirs: haut 11,5 cm, milieu 14,5 cm, milieu 24,5 cm, bas 31 cm
- 4 pare-chocs annulaires
  - 2 poignées de poussée
  - Avec 5ème roue centrale

- IT** • 4 cassetti interni in metallo con separatori HPL: superiore 11,5 cm, centrale 14,5 cm, centrale 24,5 cm, inferiore 31 cm
- 4 ruote paracolpo ricoperte di gomma antitraccia
  - Doppia maniglia di spinta
  - RS5 di serie

- DE** • 4 Metallschubladen mit verstellbarer Inneneinteilung; Stellhöhen in Schubladen: Oben 11.5 cm, Mitte 14.5 cm, Mitte 24.5 cm, Unten 31 cm
- Mit Schiebegriff
  - 4 Lenkrollen Ø150 mm sowie eine zusätzliche 5te Rolle 'RS5' zur besseren Manövrierbarkeit im beladenen Zustand

## Options



## Panel Finish

HPL



SFB



SOM



SWE



SNE

<b>BALI BAR</b>	max. 150 Kg	4 swivel x Ø150 mm 'CMP', 2 of which with brake + RS5	Steel tubing structure with HPL panels Struttura in tubo verniciato con pannelli HPL Structure en tubes d'acier avec panneaux en HPL Stahlrohrrahmen pulverbeschichtet, HPL-Platten	900x 590x h1290 mm	64 Kg	CAD00167



NEW



THELIVERIE + HOTBOX



THELIVERIE + HOTBOX

- |  |  |
|--|--|
| <p><b>EN</b></p> <ul style="list-style-type: none"> <li>• 1 drawer with separators; storage height: top 14 cm</li> <li>• With pushing handle</li> <li>• 2 height adjustable shelves</li> <li>• Single door</li> <li>• Hot Box not included</li> </ul>                        | <p><b>IT</b></p> <ul style="list-style-type: none"> <li>• 1 cassetto interno in metallo con separatori HPL alti 14 cm</li> <li>• Maniglione di spinta</li> <li>• 2 ripiani regolabili in altezza</li> <li>• Porta singola frontale</li> <li>• Hot Box non incluso</li> </ul> |
| <p><b>FR</b></p> <ul style="list-style-type: none"> <li>• 1 tiroir en métal avec séparateurs ajustables HPL. Hauteur des tiroirs: haut 14 cm</li> <li>• Poignée de poussée</li> <li>• 2 étagères ajustables</li> <li>• Porte simple</li> <li>• Hotbox non incluse</li> </ul> | <p><b>DE</b></p> <ul style="list-style-type: none"> <li>• 1 Metallschublade mit variabler Inneneinteilung aus HPL max. Höhe 14 cm</li> <li>• Mit Schiebegriff</li> <li>• 2 höhenverstellbare Einlegeböden</li> <li>• Einzeltür</li> <li>• Hotbox nicht enthalten</li> </ul>  |

Options

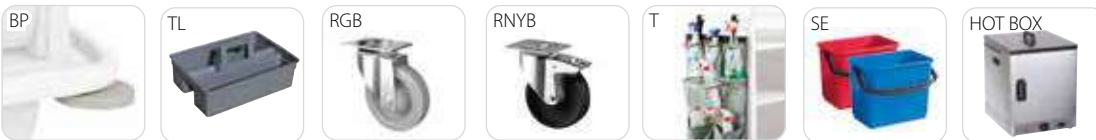

Panel Finish



<b>THELIVERIE</b>	max. 150 Kg	4 swivel castors Ø150 mm 'TPP', 2 with brakes	Laminated wood structure Struttura in legno laminato Bois mélaminé Melaminharzbeschichtetes Holz	630 x 535 x h1360 mm	Compatible only with HOT BOX and THERMOBOX	49 Kg	CAD00216

## TABLE FLIP TOP



TABLE FLIP TOP + 2 HOT BOX









- EN** • Fits up to 2 HOT BOXes at the same time  
• Whole table top flips vertically and can be stacked, saving space for nesting while not in use

- IT** • Adatto a trasportare fino a 2 HOT BOX  
• Piano ribaltabile verticalmente e impilabile quando non in uso

- FR** • Compatible avec 2 HOT BOX  
• Côtés rabattables, plateau basculant (faible encombrement)

- DE** • Verchromtes Untergestell für den Transport von bis zu 2 HOT BOXen gleichzeitig  
• Gesamte Tischplatte senkrecht abklapp- und arretierbar, daher platzsparend ineinander schiebbar

						
<b>TABLE FLIP TOP</b>	4 swivel x Ø125 mm 'TPP', 2 of which with brake	Solid CDF wood in graphite color finish, steel frame with chrome finish Top in legno CDF colore grafite, struttura in tubo cromato Bois CDF finition coloris anthracite, structure en tubes d'acier chromé CDF Holz in der Farbe graphit, verchromter Stahl	900/546x h786/1170 mm	Compatible only with HOT BOX	15 Kg	090103 





- EN** • Electrical heat box 500W made of stainless steel
- Fully insulated structure
  - 2 height adjustable mesh shelves
  - Suitable for plates up to Ø32 cm

- IT** • Box termico 500W in acciaio inox
- Struttura completamente isolata
  - 2 griglie regolabili in altezza
  - Adatto a piatti fino a Ø32 cm

- FR** • Caisson chauffant 500W en inox
- Structure entièrement isolée
  - 2 étagères ajustables en fil d'acier
  - Assiettes jusqu'à Ø32 cm

- DE** • Elektrische Wärmebox 500W aus Edelstahl
- Isolierte Wände
  - 2 höhenverstellbare Gittereinlegeböden
  - Für Teller bis Ø32 cm geeignet

### Options



<b>HOT BOX</b>	For plates up to Ø 32cm Per piatti fino a Ø 32cm Assiettes jusqu'à Ø32 cm Teller Ø bis 32 cm	Stainless steel Acciaio inox Acier inoxydable Edelstahl	405x 380x h512 mm	Compatible only with TABLE FLIP TOP BOX TAXI THELIVERIE	18 Kg	090200IN

## BOX TAXI



BOX TAXI



BOX TAXI + 6 HOT BOX

- EN**
- 2 levels for a total load capacity of 6 HOT BOXes
  - Cabling designed for either individual or simultaneous heating of HOT BOXes with just one power plug

- FR**
- Transport et charge jusqu'à 6 HOT BOX
  - Alimentation prévue pour une mise en température simultanée ou individuelle des HOT BOX avec une seule prise murale

- IT**
- 2 ripiani per una capacità di trasporto totale fino a 6 HOT BOX
  - Cablaggio adatto sia per riscaldamento singolo o simultaneo degli HOT BOX con una sola presa

- DE**
- 2 Etagen für bis zu 6 HOT BOXen
  - Separate Stromanschlüsse für jeden Stellplatz

## Options

UK



<b>BOX TAXI</b>	max. 150 Kg	4 swivel x Ø125 mm "TPP" with donut bumpers, 2 of which with brake	Stainless steel Acciaio inox Acier inoxydable Edelstahl	1467x 562x h1363 mm	Compatible only with HOT BOX	30 Kg	0902011N





TABLE FLIP TOP ECO 80



TABLE FLIP TOP ECO 90 Q+ HOT BOX ECO











TABLE FLIP TOP ECO 80

- EN**
- Fits up to 1 HOT BOX ECO
  - Whole table top flips vertically and can be stacked, saving space for nesting while not in use
  - Anti-scratch and non-slip shelf

- IT**
- Adatto a trasportare 1 HOT BOX ECO
  - Piano ribaltabile verticalmente e impilabile quando non in uso
  - Ripiano anti antigraffio ed antiscivolo

- FR**
- Compatible avec 1 HOT BOX ECO
  - Côtés rabattables, plateau basculant (faible encombrement)
  - Étagère anti-rayures et antidérapante

- DE**
- Verchromtes Untergestell für den Transport von bis zu 1 HOT BOX ECO
  - Gesamte Tischplatte senkrecht abklapp- und arretierbar, daher platzsparend ineinander schiebbar
  - Kratzfestes und rutschfestes Tischplatte

						
<b>TABLE FLIP TOP ECO 80</b>	4 swivel x Ø95 mm, 2 of which with brake	Solid MDF wood in black color finish, stainless steel frame Top in legno MDF colore nero, struttura in acciaio inox	800x h780 mm	Compatible only with HOT BOX ECO	15 Kg	CAD00221 
<b>TABLE FLIP TOP ECO 90 Q</b>	4 swivel x Ø125 mm, 2 of which with brake	Bois MDF finition coloris noir, structure en tubes d'acier inoxydable MDF Holz in der Farbe schwarz, Edelstahlrohr matt	900x h780 mm		18 Kg	CAD00222Q 



## HOT BOX ECO

NEW



HOT BOX ECO









Compatible only with:  
TABLE FLIP TOP ECO 80 -  
TABLE FLIP TOP ECO 90 Q-  
BOX TAXI ECO

- EN**
- Electrical heat box 230V made of stainless steel
  - Fully insulated structure
  - PVC handle to transport the box
  - Intermediate stainless steel shelf
  - Suitable for plates up to Ø32 cm

- IT**
- Box termico 230V in acciaio inox
  - Struttura completamente isolata
  - Maniglia in PVC per lo spostamento
  - Ripiano grigliato intermedio
  - Adatto a piatti fino a Ø32 cm

- FR**
- Caisson chauffant 230V en inox
  - Structure entièrement isolée
  - Poignée en PVC pour la transporter
  - 1 étagère en fil d'acier
  - Assiettes jusqu'à Ø32 cm

- DE**
- Elektrische Wärmebox 230V aus Edelstahl
  - Isolierte Wände
  - PVC-Griff zum transportieren
  - 1 Gitter Einlegeboden
  - Für Teller bis Ø32 cm geeignet

							
<b>HOT BOX ECO</b>	For plates up to Ø 32cm Per piatti fino a Ø 32cm Assiettes jusqu'à Ø32 cm Teller Ø bis 32 cm	Stainless steel Acciaio inox Acier inoxydable Edelstahl	450x 460x h510 mm	Compatible only with TABLE FLIP TOP ECO BOX TACE ECO	12 Kg	400 W	CAD00224 



NEW



BOX TAXI ECO + 6 HOT BOX ECO

- EN**
- 2 levels for a total load capacity of 6 HOT BOXes ECO
  - Cabling designed for either individual or simultaneous heating of HOT BOXes ECO with just one power plug

- IT**
- Due livelli per il trasporto fino a 6 HOT BOX ECO alla volta
  - Dotato di alimentatore per il riscaldamento simultaneo o individuale di HOT BOX ECO con una presa a parete singola

- FR**
- Transporte et charge jusqu'à 6 HOT BOX ECO
  - Alimentation prévue pour une mise en température simultanée ou individuelle des HOT BOX ECO avec une seule prise murale

- DE**
- 2 Etagen für bis zu 6 HOT BOXen ECO
  - Separate Stromanschlüsse für jeden Stellplatz

<b>BOX TAXI ECO</b>	max. 150 Kg	4 swivel x Ø125 mm with donut bumpers, 2 of which with brake	Stainless steel Acciaio inox Acier inoxydable Edelstahl	1530x 560x h1390 mm	Compatible only with HOT BOX ECO	25 Kg	2400 W	CAD00223

## PASSEPARTOUT 2 / 3 / PL 3

NEW



PASSEPARTOUT 2



PASSEPARTOUT 3



PASSEPARTOUT 3 PL

- EN** • Shelves with retaining bars in chrome finish (PASSEPARTOUT 2 / 3)  
 • Shelves with edges (PASSEPARTOUT 3 PL)  
 • Side pushing bars

- IT** • Ripiani con spondine di protezione cromate (PASSEPARTOUT 2 / 3)  
 • Ripiani con bordi di protezione (PASSEPARTOUT 3 PL)  
 • Maniglioni di spinta

- FR** • Étagères avec barres de retention en finition chromée (PASSEPARTOUT 2 / 3)  
 • Étagères avec rebords (PASSEPARTOUT 3 PL)  
 • Poignée de poussée

- DE** • 2 bzw. 3 Etagen mit Schutzreling aus Edelstahl (PASSEPARTOUT 2 / 3)  
 • Fachböden mit Kanten (PASSEPARTOUT 3 PL)  
 • Schiebegriff

## Panel Finish PASSEPARTOUT 2 / 3



PMB



PBE



PWE



Many other colors available with MOQ.  
 Information in panel finish section.

<b>PASSEPARTOUT 2</b>	100 kg	4 swivel x Ø100 mm 'TPP' with donut bumper	Tube frame with chrome finish, laminated wood Struttura cromata, ripiani in legno laminato	980x 470x h945 mm	040102WD
<b>PASSEPARTOUT 3</b>	150 kg		Structure tubes acier chromé, bois mélaminé Edelstahl Rohrstruktur, melaminharzbeschichtetes Holz	980x 470x h945 mm	040103WD
<b>PASSEPARTOUT PL 3</b>	40 kg	4 swivel x Ø100 mm	Plastic shelves with anodised aluminium uprights Struttura in plastica con montanti in alluminio anodizzato Plastique étagères avec montants en Aluminium Kunststoff mit Trägern aus eloxiertem Aluminium.	850x 430x h950 mm	CAD1008PL-F

## LUGGAGE RACK CR / S



## LUGGAGE RACK BR / S









- EN**
- Luggage rack with an universal design, perfect for every hotel
  - Model S with backrest for better support of the suitcase
  - Foldable

- IT**
- Reggivalige dal design universale, ideale per ogni hotel
  - Modello S provvisto di schienale per un sostegno migliore della valigia
  - Pieghevole

- FR**
- Porte-bagages au design universel, parfait pour chaque hôtel
  - Modèle S avec dossier pour un meilleur support de la valise
  - Pliable

- DE**
- Gepäckablage mit universellem Design, perfekt für jedes Hotel
  - Modell S mit Rückenlehne für besseren Halt des Koffers
  - Zusammenklappbar

						
<b>LUGGAGE RACK CR</b>	max. 60 Kg	Brushed chromed steel with PVC black belts, with backrest (S) Acciaio cromato con cinghie nere in PVC provvisto di schienale (S)	680x 430x h520 mm	Tubes diameter 25 mm Tubular thickness 0.8 mm	1,6 Kg	CAD00031
<b>LUGGAGE RACK CR S</b>		Tubes d'acier chromé et sangles en PVC noir, avec dossier (S) Chromstahl gebürstet, schwarze PVC-Gurte	680x 430x h715 mm		2,6 Kg	CAD00032
<b>LUGGAGE RACK BR</b>		Steel tube with brass finish with PVC black belts, with backrest (S) Acciaio con finitura ottonata con cinghie nere in PVC provvisto di schienale (S)	680x 430x h520 mm		1,6 Kg	CAD00033
<b>LUGGAGE RACK BR S</b>		Tubes d'acier finition laiton, sangles en PVC, noir, avec dossier (S) Stahl vermessingt, schwarze PVC-Gurte	680x 430x h715 mm		2,6 Kg	CAD00034

## LUGGAGE RACK W-LNO / WS-LNO

NEW



LUGGAGE RACK W-LNO

NEW



LUGGAGE RACK WS-LNO

- EN**
- Sturdy and attractive design
  - Easy clean up
  - Foldable
  - Easy one hand fold
  - Model S with backrest for better support of the suitcase

- IT**
- Design robusto e accattivante
  - Facile da pulire
  - Pieghevole
  - Si piega con una mano
  - Modello S provvisto di schienale per un sostegno migliore della valigia

- FR**
- Design robuste et attrayant
  - Facile à nettoyer
  - Pliable
  - Pliage facile d'une main
  - Modèle S avec dossier pour un meilleur support de la valise

- DE**
- Robustes und ansprechendes Design
  - Einfach aufzuräumen
  - Zusammenklappbar
  - Einfach mit einer Hand falten
  - Modell S mit Rückenlehne für besseren Halt des Koffers

					
<b>LUGGAGE RACK W-LNO</b>	max. 50 Kg	Dark walnut wood with Nylon black belts Struttura in legno di noce scuro con cinghie nere in Nylon Noyer foncé et sangles en nylon Kiefernholz, schwarze Nylon-Gurte	480x480x h530 mm	2 Kg	CAD00123. LNO
<b>LUGGAGE RACK WS-LNO</b>			480x480x h580 mm		CAD00213S. LNO











- EN**
- Refillable polish container, capacity 150 ml
  - Automatic switch on / switch off by shoes approaching sensor
  - Powering: 230V - 50 Hz
  - Soft base for footwear
  - Non-slip feet

- IT**
- Contenitore cera ricaricabile, capacità 150 ml
  - Attivazione / spegnimento automatici con sensore presenza scarpe
  - Alimentazione: 230 V - 50 Hz
  - Base d'appoggio della calzatura morbida
  - Piedi antiscivolo

- FR**
- Récipient cire rechargeable, capacité 150 ml
  - Activation et arrêt automatique grâce à un capteur de présence de chaussure
  - Alimentation: 230 V - 50 Hz
  - Base de support pour chaussures souples
  - Pieds antidérapants

- DE**
- Nachfüllbarer Farbbehälter, Kapazität 150 ml
  - Automatisches Ein- / Ausschalten durch Schuhannäherungssensor
  - Stromversorgung: 230 V - 50 Hz
  - Stützbasis für weiches Schuhwerk
  - Rutschfeste Füße

\* REVOLUTIONS PER  
MINUTE

						
<b>LUCY</b>	1200 rpm*	Stainless steel Acciaio inox Acier inoxydable Edelstahl	200x 370x h330 mm	100 W	6,2 Kg	CAD00091

## FOLDIE ECO









- EN**
- Easily foldable
  - Wooden slats, light, easy to assemble
  - Mattress included
  - Swiveling wheels for easy transport
  - Mattress color subject to availability

- IT**
- Facile da richiudere quando non in uso
  - Doghe in legno, leggero, facile da montare
  - Materasso incluso
  - Ruote girevoli per facilitare il trasporto
  - Colore del materasso secondo disponibilità

- FR**
- Structure entièrement pliable
  - Lattes de bois, léger et facile à monter
  - Matelas inclus
  - Roues pivotantes pour un transport facile
  - Couleur du matelas selon disponibilité

- DE**
- Einfach klappbar
  - Kopteil, Bezug inklusive
  - Holz-Lattenrost, leicht
  - Schwenkräder für einfachen Transport
  - Matratzenfarbe je nach Verfügbarkeit

						
<b>FOLDIE ECO</b>	max. 150 Kg	Ø 40 mm	Steel tube frame Struttura in metallo Cadre renforcé Verstärkte Metallrahmenkonstruktion	800x 1840x h390 mm	12 Kg	CADBR01 





Extra mattress available  
MAT Opt.

- EN**
- Easily foldable
  - Corner protection
  - Standard mattress 2 cm (thickness)
  - Side opening with zipper
  - Portable with carry handle

- IT**
- Facilmente richiudibile quando non in uso
  - Protezioni angolari
  - Materassino standard spesso 2 cm
  - Lato con apertura a zip
  - Sacca per riporlo comodamente quando non in uso

- FR**
- Cadre renforcé et moussé entièrement pliable
  - Protections angulaires
  - Matelas standard épaisseur 2 cm
  - Côté ouvrant avec fermeture éclair
  - Transportable avec poignée

- DE**
- Verstärkte Metallrahmenkonstruktion mit Klappmechanismus
  - Bunter Eckschutz
  - 2 cm Flachmatratze (Standard)
  - Vordere Ausstiegsöffnung mit Reißverschluss
  - Tasche zum praktischen Verstauen und Lagern bei Nichtgebrauch

### Options



	 KG				 KG	 CODE
<b>BABY BED SLEEP'N PLAY</b>	max. 15 Kg	2 x Ø 100 mm	Steel tube frame Scheletro in metallo Cadre renforcé Verstärkte Metallrahmenkonstruktion	1250x 690x h850 mm	7,5 Kg	090300PL



## BEDDIE ERGO S

NEW



- EN**
- Easily foldable
  - Standard mattress 2 cm (thickness)
  - Internal dimensions: 90x60 cm

- IT**
- Facilmente richiudibile quando non in uso
  - Materassino standard spesso 2 cm
  - Dimensioni interne: 90x60 cm

- FR**
- Cadre renforcé et moussé entièrement pliable
  - Matelas standard épaisseur 2 cm
  - Dimensions intérieures: 90x60 cm

- DE**
- Verstärkte Metallrahmenkonstruktion mit Klappmechanismus
  - 2 cm Flachmatratze (Standard)
  - Innenmaße: 90x60 cm

## Options



<b>BEDDIE ERGO S</b>	max. 15 Kg	4 swivel x Ø40 mm, 2 of which with brake	Pine wood Struttura in legno di pino Pin Kiefernholz	660x 1010x h960 mm	13 Kg	CAD00095S



# FOOD SERVICE

**EN Style & service:** functionality matches with style. We are constantly looking for new solutions to meet your standards and needs, providing you the best alternatives for a high level F&B service.

**IT Lo stile nel servire:** funzionalità senza dimenticare lo stile. Siamo sempre alla ricerca di soluzioni all'altezza delle vostre strutture, in grado di garantirvi un servizio F&B di alta qualità

**FR Style & service:** la fonctionnalité s'associe au style. Nous recherchons constamment de nouvelles solutions pour répondre aux besoins, tout en apportant un service F&B de qualité.

**DE Stil & Service:** funktionalität trifft Stil. Wir sind ständig auf der Suche nach neuen Lösungen, die Ihren Standards sowie Anforderungen entsprechen und Ihnen die besten Alternativen für einen erstklassigen F & B Service bieten.





- EN**
- Lockable shutter
  - 2 height-adjustable shelves
  - Non marking and full wrap-around rubber bumper
  - 2 side folding shelves in steel with bumpers

- IT**
- Chiusura a serranda con serratura
  - 2 ripiani regolabili in altezza
  - Bordo paracolpo in gomma antitraccia
  - 2 ripiani pieghevoli laterali in acciaio con paraurti

- FR**
- Volet roulant verrouillable
  - 2 niveaux étagères ajustables
  - Pare-chocs intégral non-marquant
  - 2 étagères latérales rabattables en acier et pare-chocs annulaires d'angle non marquants

- DE**
- Abschließbarer Kunststoffrollo inkl. Schloss
  - 2 höhenverstellbare Einlegeböden
  - Abriebfester und umlaufender Gummistoßschutz mit Schutzreling
  - 2 seitliche Klappböden aus Stahl mit Abweisinge

### Options



### Panel Finish for Coffie

HPL



SFB



SOM



SWE



SNE

<b>COFFIE</b>	200 Kg	4 swivel x Ø150 mm 'CMP'	Steel tubing structure with HPL panels Struttura in tubo d'acciaio con pannelli HPL Structure en tubes d'acier avec panneaux en HPL Stahlrohrrahmen mit HPL-Platten	1334x 566x h1491 mm	42 Kg	CAD00047

## TRAY STAND W

NEW



TRAY NOT INCLUDED

- EN**
- Sturdy and attractive design
  - Easy clean up
  - Easy one-hand fold

- IT**
- Design robusto e accattivante
  - Facile da pulire
  - Si piega con una mano

- FR**
- Design robuste et attrayant
  - Facile à nettoyer
  - Pliage facile d'une main

- DE**
- Robustes und ansprechendes Design
  - Einfache Reinigung

						
<b>TRAY STAND W</b>	50 Kg	-	Pine wood with PVC black belts, with backrest Struttura in legno di pino con cinghie nere in PVC Structure en pin avec sangles en PVC noires Kiefernholz mit schwarzem PVC-Branch	600x 500x h800 mm	3,5 Kg	CAD554



## CADDINOX 2



## CADDINOX 3



- EN**
- 2 or 3 shelves with a perimetric profiled upstand, soundproofed and with satin finish
  - Stainless steel round tube frame, Ø 25 mm
  - Side pushing bars





- IT**
- 2 o 3 ripiani con bordo arrotondato, insonorizzati e con finitura satinata
  - Struttura in tubo tondo di acciaio inox Ø 25 mm
  - Maniglioni di spinta

- FR**
- 2 ou 3 étagères avec rebord, insonorisées et satinées
  - Structure en tube rond en acier inoxydable Ø 25 mm
  - Poigne de pousse

- DE**
- 2 oder 3 Ebenen, jeweils mit Aufkantung
  - Edelstahl Rundrohrrahmen Ø25 mm
  - Schiebebügel
  - 4 Abweisinge

### Options



					
<b>CADDINOX 2</b>	max. 100 Kg	4 swivel x Ø 125 mm "TPP"	Stainless steel Acciaio inox Acier inoxydable Edelstahl	900x 600x h940 mm	100101IN
<b>CADDINOX 3</b>				900x 600x h1040 mm	100102IN

## SUPER CADDINOX 2



- EN**
- 2 or 3 shelves with a perimetric profiled upstand
  - 4 donut bumpers
  - Stainless steel round tube closed frame, Ø 25 mm

- FR**
- 2 ou 3 étagères avec rebords
  - 4 pare-chocs en caoutchouc
  - Structure en acier inoxydable tube Ø 25mm

## SUPER CADDINOX 3



- IT**
- 2 o 3 ripiani con bordo
  - 4 paracolpi in gomma
  - Struttura in tubo tondo di acciaio inox Ø 25 mm

- DE**
- 2 oder 3 Ebenen, jeweils mit Aufkantung
  - Edelstahl Rundrohrrahmen Ø25 mm
  - Schiebebügel
  - 4 Abweisinge

## Options



<b>SUPER CADDINOX 2</b>	max. 200 Kg	4 swivel x Ø 125 mm 'TPP', 2 of which with brake	Welded stainless steel Acciaio inox saldato Acier inoxydable soudé Geschweißter Edelstahl	1090x 590x h950 mm	17 Kg	100201IN
<b>SUPER CADDINOX 3</b>					22 Kg	100202IN



## VERSO 12

NEW

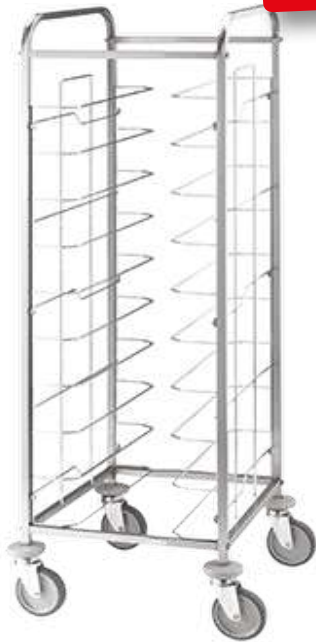

- EN** • 12 tray holder foldable shelves in chrome-plated steel
- Stainless steel square tube construction
  - Suitable for trays of max 53x39 cm

- IT** • 12 ripiani porta vassoi in filo d'acciaio cromato
- Struttura in tubo quadro di acciaio inox
  - Vassoi con dim. max 53x39 cm

- FR** • 12 porte-plateaux en fil acier chromé
- Structure en tube carré en acier inoxydable
  - Plateaux dim. max 53x39 cm

- DE** • 12 klappbare Tablettsschübe in verchromtem Stahl
- Edelstahl Vierkantrohrgestell
  - Passend für Tablettss max. Maß 53x39 cm

## VERSO 12P

NEW



- EN** • 12 tray holder foldable shelves in chrome-plated steel
- Stainless steel square tube construction with 2-side tobacco oak panels
  - Suitable for trays of max 53x39 cm

- IT** • 12 ripiani porta vassoi in filo d'acciaio cromato
- Struttura in tubo quadro di acciaio inox con pannelli laterali con finitura Rovere Tabacco
  - Vassoi con dim. max 53x39 cm







- FR** • 12 porte-plateaux en fil acier chromé
- Structure en tube carré en acier inoxydable et panneaux latéraux finition Chêne Tabac
  - Plateaux dim. max 53x39 cm

- DE** • 12 klappbare Tablettsschübe in verchromtem Stahl
- Edelstahl Vierkantrohrgestell mit 2 Seitenwänden
  - Passend für Tablettss max. Maß 53x39 cm

## Options

DR-T



						
<b>VERSO 12</b>	max. 100 Kg	4 swivel x Ø125 mm with donut bumper	Stainless steel frame (with lateral laminated wood Verso 12P)	520x 600x h1830 mm	15,5 Kg	CAD00217
<b>VERSO 12P</b>			Struttura in acciaio inox (con pannelli in legno nobilitato Verso 12P)			
			Structure en tubes d'acier inoxydable (bois MDF finition coloris noir Verso 12P)			
			Edelstahlrohr matt (MDF Holz in der Farbe schwarz Verso 12P)		25 Kg	CAD00218



## VERSO 24

NEW

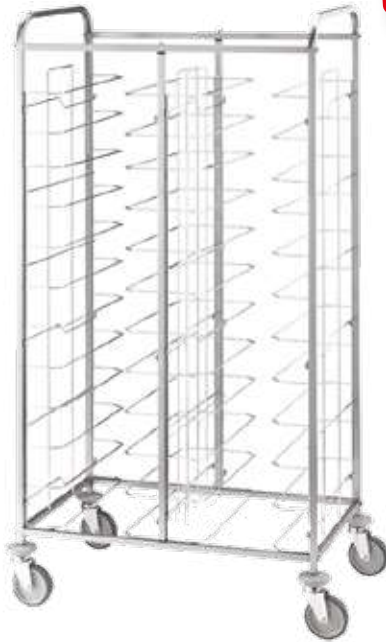

## VERSO 24P

NEW



- EN** • 2 compartments of 12 tray holder foldable shelves each in chrome-plated steel
- Stainless steel square tube construction
  - Suitable for trays of max 53x39 cm

- IT** • 2 colonne da 12 ripiani porta vassoi ciascuna in filo d'acciaio cromato
- Struttura in tubo quadro di acciaio inox
  - Vassoi con dim. max 53x39 cm

- FR** • 2 colonnes à 12 niveaux porte plateaux en fil d'acier chromé
- Structure en tube carré en acier inoxydable
  - Plateaux dim. max 53x39 cm

- DE** • 2x 12 klappbare Tablettschübe in verchromtem Stahl
- Edelstahl Vierkanthohrgestell
  - Passend für Tablett max. Maß 53x39 cm

- EN** • 2 compartments of 12 tray holder foldable shelves each in chrome-plated steel
- Stainless steel square tube construction with 2-side tobacco oak stained melamine-faced panels
  - Suitable for trays of max 53x39 cm

- IT** • 2 colonne da 12 ripiani porta vassoi ciascuna in filo d'acciaio cromato
- Struttura in tubo quadro di acciaio inox e pannelli laterali con finitura Rovere Tabacco
  - Vassoi con dim. max 53x39 cm







- FR** • 2 colonnes à 12 niveaux porte plateaux en fil d'acier chromé
- Structure en tube carré en acier inoxydable et panneaux latéraux finition Chêne Tabac
  - Plateaux dim. max 53x39 cm

- DE** • 2x 12 klappbare Tablettschübe in verchromtem Stahl
- Edelstahl Vierkanthohrgestell mit 2 Seitenwänden
  - Passend für Tablett max. Maß 53x39 cm

## Options

DR-T



						
<b>VERSO 24</b>	max. 200 Kg	4 swivel x Ø125 mm with donut bumper	Stainless steel frame (with lateral laminated wood Verso 24P)	950x 600x h1830 mm	25 Kg	CAD00219
<b>VERSO 24P</b>			Struttura in acciaio inox (con pannelli in legno nobilitato Verso 24P)		34,5 Kg	CAD00220
			Structure en tubes d'acier inoxydable (bois MDF finition coloris noir Verso 24P)			
			Edelstahlrohr matt (MDF Holz in der Farbe schwarz Verso 24P)			



## ALTO 2



ALTO 2

- EN • 2 tiers
- Tiny elegant chromed details
  - Side pushing bars

- IT • 2 ripiani
- Piccoli dettagli cromati
  - Maniglie di spinta

- FR • 2 niveaux
- Détails en finition chromée
  - Poigne de pousse

- DE • 2 Etagen
- Mit Chrom-Details
  - Seitliche Schiebegriffe

## Options



## Panel Finish

## SW



RAL



MNO



MGR



MWE

## ALTO 3



ALTO 3

- EN • 3 tiers
- Tiny elegant chromed details
  - Side pushing bars

- IT • 3 ripiani
- Piccoli dettagli cromati
  - Maniglie di spinta

- FR • 3 niveaux
- Détails en finition chromée
  - Poigne de pousse

- DE • 3 Etagen
- Mit Chrom-Details
  - Seitliche Schiebegriffe

**ADDITIONAL MODELS AVAILABLE**  
**ALTRI MODELLI DISPONIBILI**  
**PLUS DE MODÈLES DISPONIBLES**  
**MEHR MODELLE VERFÜGBAR**

Options only available for the products marked with '\*'  
 Optional disponibile solo per i prodotti segnati con '\*'  
 Options seulement disponibles pour les produits désignés par '\*'  
 Optionen nur für die mit \* markierten Modelle

## ALTO FLAMBÈ



ALTO FLAMBÈ

- EN**
- Stainless steel worktop
  - Equipped with single stove, drawer and an integrated bottle holder

- IT**
- Piano in acciaio
  - Dotato di un bruciatore a fuoco singolo, cassetto di servizio e di un portabottiglie integrato nel piano di lavoro

- FR**
- Étagère en acier inoxydable
  - Équipé d'un feu, tiroir de service et support bouteilles intégré dans l'étagère supérieur

- DE**
- Obere Etage mit Edelstahl ausgelegt
  - Flambierwagen mit einem sicheren Einzel-Spiritusbrenner
  - Mit einer Schublade und einem integriertem Flaschenhalter

## ALTO 5 PM



ALTO 5PM

- EN**
- Integrated display case for food & beverage refrigerated by means of chilling packs
  - Protection frame (included)

- IT**
- Dotato di una vetrinetta integrata per il servizio di cibi e bevande, refrigerata con piastre eutettiche
  - Spondine di protezione (incluse)

- FR**
- Équipé d'une vitrine réfrigérée avec pack réfrigérant
  - Cadre de protection supérieur (compris)

- DE**
- Verfügt über eine integrierte Vitrine für Süßwaren
  - Gekühlt mittels Kühllakus
  - Obere Etage mit Schutzreling

					
<b>ALTO 2 *</b>	max. 100 Kg	4 swivel x Ø100 mm	Solid wood Legno massello Bois massif Massivholz	1015x 570x h1121 mm	CAD00173
<b>ALTO 3</b>				1015x 570x h1121 mm	CAD00174
<b>ALTO FLAMBÈ</b>				1015x 570x h936 mm	CAD00177
<b>ALTO 5PM</b>				1015x 570x h900 mm	CAD00181

## ALTO WINE



ALTO WINE

- EN** • Equipped by: drawer, glass rack, cork collection pan, bottles display
- 4 bottles coolers placed on a chilling pack ensuring up to 5 hours of cooling autonomy

- IT** • Dotato di: cassetto, rastrelliera porta bicchieri, espositore di bottiglie, vaschetta porta tappi
- 4 recipienti su piastra eutettica con autonomia fino a 5 ore di servizio

- FR** • Équipé de: tiroir, râtelier à verres, bac de collecte de bouchons, présentoir de bouteilles
- Pack réfrigérant assurant jusqu'à 5 heures de refroidissement

- DE** • Schublade, Gläsergestell, Korkauffangschale und Untergestell mit spezieller Anrichte für die Flaschenpräsentation
- 4 Flaschenkühler, die auf einem Kühlakku platziert sind und bis zu 5 Stunden Kühltemperatur gewährleisten

## ALTO MIXOLOGY



ALTO MIXOLOGY

- EN** • Stainless steel tiers equipped with 2 GN 1/3 pans, 1 metal box and frontal acrylic glass structure
- Double glass/bottle holder structure

- IT** • Piano in acciaio inox con 2 vasche GN 1/3, 1 cassetta e alzatina frontale in plexiglass
- Doppia rastrelliera inferiore

- FR** • Étagère supérieur en acier inoxydable équipé de 2 GN 1/3, 1 conteneur métallique et une protection en verre acrylique
- Support verres et bouteilles

- DE** • Oberfläche aus Edelstahl und ausgestattet mit zwei GN 1/3 Behälter, 1 Metallbox und einer vertikal aufgestellten Glasscheibe
- Mit praktischer Flaschen-Gläser-Halterung

## Options



## Panel Finish

SW



RAL



MNO



MGR



MWE

**ADDITIONAL MODELS AVAILABLE**  
**ALTRI MODELLI DISPONIBILI**  
**PLUS DE MODÈLES DISPONIBLES**  
**MEHR MODELLE VERFÜGBAR**

Options only available for the products marked with '\* \*'  
 Opzionale disponibile solo per i prodotti segnati con '\* \*'  
 Options seulement disponibles pour les produits désignés par '\* \*'  
 Optionen nur für die mit \* markierten Modelle

## ALTO BOLLA



ALTO BOLLA

## ALTO ICE 3



ALTO ICE 3

- EN** • Equipped by: 2 glass racks, ice bucket and 2 bottle coolers  
• Upper tier is laid with marble materic HPL finish

- IT** • Dotato di: rastrelliere porta bicchieri, secchiello per bottiglie, 2 glacette  
• Ripiano superiore rivestito in HPL finitura marmo

- FR** • Equipé de 2 râteliers en verre et seau à glace  
• Plateau supérieur en HPL finition marbre

- DE** • Verfügt über einen Glasständer aus Acrylglas, Eiskübel und zwei Flaschenkühler  
• Der obere Teil ist mit Marmor ausgelegt

- EN** • 2 to 3 tiers with detachable refrigerated display case with hemispherical dome with double side opening  
• Chilling pack ensuring up to 5 hours of cooling autonomy

- IT** • 2 o 3 ripiani con vetrina espositiva refrigerata asportabile a doppia apertura  
• Refrigerazione tramite piastre eutettiche con autonomia fino a 5 ore di servizio

- FR** • Présentoir réfrigéré détachable avec dôme hémisphérique à double ouverture sur 2 ou 3 étages  
• Pack réfrigérant assurant jusqu'à 5 heures de refroidissement

- DE** • 2 oder 3 Etagen, mit abnehmbarer Kühlvitrine  
• Halbkugelförmige Kuppel, beidseitig zu öffnen  
• Kühlung mittels Kühllakus für bis zu 5 Stunden Betrieb

					
<b>ALTO WINE</b>	max. 100 Kg	4 swivel x Ø100 mm	Solid wood Legno massello Bois massif Massivholz	1015x 570x h1019 mm	CAD00178
<b>ALTO BOLLA</b>				1015x 570x h1121 mm	CAD00179
<b>ALTO MIXOLOGY</b>				1015x 570x h1121 mm	CAD00180
<b>ALTO ICE 3 *</b>				1015x 570x h1197 mm	CAD00211



**CMM**

Housing made of pressed steel, bright zinc plated  
Wheel center made of polypropylene  
Double ball bearing  
Thermoplastic rubber tread  
Can be used for many floor types  
Very durable  
Very good maneuverability  
Tread leaves no marks on the floor

Supporto in lamiera d'acciaio zincato  
Nucleo in polipropilene  
Doppio giro di cuscinetti a sfera  
Rivestimento in gomma termoplastica  
Possono essere utilizzate su diversi tipi di superficie  
Molto resistenti  
Ottima manovrabilità  
Antitraccia

Chappe en acier galvanisé brillant  
Corps de galet en polypropylène  
Double roulement à billes  
Bandage caoutchouc  
Utilisation possible sur de nombreux type de sols  
Très durable  
Très bonne maniabilité  
Non marquantes

Gehäuse aus verzinktem Stahl  
Radkörper aus Polypropylen  
Doppeltes Kugellager  
Lauffläche aus einer thermoplastischen Gummimischung  
Für viele Bodentypen geeignet  
Sehr stabil  
Leicht gängig  
Hinterlässt keine Finituraspuren auf Böden

**CMP**

Housing made of Polyamid in RAL 7001  
Double ball bearing  
Thermoplastic rubber tread  
Ideal for hard and even floors  
Very quiet  
Non-corrosive  
Tread leaves no marks on the floor

Supporto poliammide RAL 7001  
Doppio giro di cuscinetti a sfera  
Rivestimento in gomma termoplastica  
Ideali per superfici dure e regolari  
Molto silenziose  
Anticorrosione  
Antitraccia

Chappe en polyamide gris RAL 7001  
Double roulement à billes  
Bandage caoutchouc  
Idéales pour sols durs et réguliers  
Très silencieuses  
Absence de risque de corrosion  
Non marquantes

Kunststoffgabel aus Polyamid in RAL 7001  
Doppeltes Kugellager  
Lauffläche aus einer thermoplastischen Gummimischung  
Für ebene und eher harte, feinfugige Bodentypen geeignet  
Sehr leise  
Keine Korrosion  
Hinterlässt keine Spuren auf Böden

**PNP**

Wheel center made of polypropylene  
Foamed polyurethane tread  
Precision ball bearing  
Only for Orsa  
Can be used for many floor types, also for outdoor  
Almost wear-free  
Low rolling-resistance

Nucleo in polipropilene  
Rivestimento in schiuma poliuretana  
Cuscinetti a sfera di precisione  
Possono essere utilizzate su diversi tipi di superficie, anche all'esterno  
Praticamente indistruttibili  
Ottima scorrevolezza  
Disponibile solo per il carrello Orsa

Corps de galet en polypropylène  
Roulement à billes de précision  
Bandage en polyuréthane moussé  
Seulement pour Orsa  
Utilisation possible sur de nombreux types de sols, également en extérieur  
Quasi-inusables  
Faible résistance au roulement

Radkörper aus Polypropylen  
Lauffläche aus geschäumtem Polyurethan  
Präzisionskugellager  
Für viele Bodentypen geeignet, auch Outdoor  
Nahezu verschleißfrei  
Geringer Rollwiderstand

**RG**

Housing made of pressed steel, bright zinc plated  
Double ball bearing  
Elastic rubber tread  
Ideal for hard and uneven floors  
Vibration absorbent  
Very quiet

Supporto in lamiera d'acciaio con zincatura brillante  
Doppio giro di cuscinetti a sfera  
Rivestimento in gomma elastica  
Ideali per superfici dure e irregolari  
Antivibrazione  
Molto silenziose

Chappe en acier galvanisé brillant  
Double roulement à billes  
Bandage caoutchouc élastique  
Idéales pour sols durs et irréguliers  
Absorbe les vibrations  
Très silencieuses

Gehäuse aus verzinktem Stahl  
Doppeltes Kugellager  
Lauffläche aus elastischem Gummi  
Ideal für harte und unebene Böden  
Schwingungsabsorbierend  
Sehr leise



## RNY

Housing made of pressed steel, bright zinc plated  
 Double ball bearing swivel head  
 Plain bearing  
 Nylon tread  
 Ideal for soft floors such as deep carpet  
 Very durable and wear-free  
 Very good maneuverability

Supporto in lamiera d'acciaio con zincatura brillante  
 Doppio giro di cuscinetti a sfera sul supporto girevole  
 Foro passante  
 Rivestimento in nylon  
 Ideali per superfici morbide come la moquette  
 Molto solide e resistenti  
 Ottima manovrabilità

Chappe en acier galvanisé brillant  
 Pivot à double roulement à billes  
 Roulement à billes  
 Bandage dur nylon  
 Idéales pour sols souples type moquette profonde  
 Très durables et solides  
 Très bonne maniabilité

Gehäuse aus glanzverzinktem Stahlblech  
 Schwenklager mit zweifachem Kugelkranz  
 Gleitlager  
 Lauffläche aus Polyamid/Nylon  
 Ideal für weiche Böden wie tiefflorige Teppiche  
 Sehr langlebig und wartungsfrei  
 Gute Manövrierbarkeit



## RSS

Wheels center made of polypropylen  
 Full rubber tread  
 Roller bearing  
 Gentle to floor thanks to the soft material  
 Excellent maneuverability and rotation capacity

Nucleo in polipropilene  
 Cuscinetti a rulli  
 Rivestimento in gomma  
 Materiale morbido che preserva le superfici  
 Ottima manovrabilità e capacità di rotazione

Corps de galet en polypropylène  
 Bandage caoutchouc plein  
 Roulement à rouleau  
 Matériau très souple, préservant le revêtement de sol  
 Très bonne maniabilité et capacité à la rotation

Radkörper aus Polypropylen  
 Lauffläche aus Vollgummi  
 Rollenlager  
 Sehr bodenschonend, da sehr weiches Material  
 Leichte Manövrierbarkeit / Drehbarkeit



## TPP

Housing made of high grade synthetic material  
 Double ball bearing swivel head  
 Precision ball bearing  
 Thermoplastic rubber tread  
 Very quiet  
 Tread leaves no marks on the floor  
 Non-corrosive  
 Vibration absorbent

Supporto in materiale plastico di alta qualità  
 Doppio giro di cuscinetti a sfera sul supporto girevole  
 Cuscinetti a sfera di precisione  
 Rivestimento in gomma termoplastica  
 Molto silenziose  
 Resistente alla corrosione  
 Antitraccia  
 Antivibrazione

Chappe en matériau plastique haute qualité  
 Pivot à double roulement à billes  
 Roulement à billes de précision  
 Bandage caoutchouc  
 Très silencieuses  
 Non marquantes  
 Absence de risque de corrosion  
 Absorbe les vibrations

Gehäuse aus hochwertigem Kunststoff  
 Schwenklager mit zweifachem Kugelkranz  
 Präzisionskugellager  
 Lauffläche aus einer thermoplastischen Gummimischung  
 Sehr leise  
 Hinterlässt keine Spuren auf Böden  
 Keine Korrosion  
 Schwingungsabsorbierend



## TPS

Housing made of pressed steel, bright zinc plated  
 Roller bearing  
 Thermoplastic rubber tread  
 Can be used for many floor types  
 Very quiet  
 Tread leaves no marks on the floor  
 Non-corrosive  
 Vibration absorbent

Supporto in lamiera d'acciaio con zincatura brillante  
 Cuscinetti a rulli  
 Rivestimento in gomma termoplastica  
 Possono essere utilizzate su diversi tipi di superficie  
 Molto silenziose  
 Resistente alla corrosione  
 Antitraccia  
 Antivibrazione

Chappe en acier galvanisé brillant  
 Roulement à rouleau  
 Bandage caoutchouc  
 Utilisation possible sur de nombreux types de sols  
 Très silencieuses  
 Absence de risque de corrosion  
 Non marquantes  
 Absorbe les vibrations

Gehäuse aus glanzverzinktem Stahlblech  
 Kugellager  
 Lauffläche aus einer thermoplastischen Gummimischung  
 Für viele Bodentypen geeignet  
 Sehr leise  
 Hinterlässt keine Finituraspuren auf Böden  
 Keine Korrosion  
 Schwingungsabsorbierend



## TT

Wheel center made of pressed steel  
 Only for Orsa  
 Pneumatic wheels, tread leaves no marks on the floor  
 Roller bearing  
 High load capacity, antislip  
 Easy crossing of threshold

Nucleo in lamiera d'acciaio  
 Solo per Orsa  
 Ruota pneumatica, antitraccia  
 Cuscinetti a rulli  
 Grande portata, antiscivolo  
 Adatte a superare piccoli ostacoli

Corps de galet en acier  
 Seulement pur Orsa  
 Bandage pneumatique, non marquantes  
 Roulement à billes  
 Haute charge utilis, antidérapantes  
 Facilite le passage de petits obstacles

Radkörper aus Stahlblech  
 Nur für Orsa  
 Luftbereifung mit Blockprofil  
 Kugellager  
 Hohe Zuladung möglich, Rutschfest  
 Einfaches Überwinden von Schwellen



**Broom clip**  
One broom clip, possibility to add more  
**Clip per scopa**  
Clip per scopa, possibilità di aggiungerne altre

**Clip à balai**  
Un seul clip à balai, possibilité d'en ajouter d'autres  
**Besensclip**  
Ein Besensclip, erweiterbar



**Linen bag holder, powder coated**  
Upper liftable holder  
Lower liftable base with metal bars and abrasion-proof, non-marking donut bumpers Ø 100 mm  
Robust, water-repellent PES laundry bag (127 Ltr.) in burgundy red  
**Kit sacco biancheria BDX**  
Supporto superiore ribaltabile  
Supporto inferiore ribaltabile con barre in metallo e ruote paracolpo antitraccia Ø 100 mm  
Sacco biancheria bordeaux PES idrorepellente (127 Ltr.)

**Support sac à linge**  
Support relevable supérieur  
Support inférieur relevable avec barres anti-affaissement et 2 pare-chocs annulaires d'angle non marquant Ø 100 mm  
Sac à linge hydrophobe très solide coloris bordeaux 127 Ltr.

**Wäschesackhalterung, pulverbeschichtet**  
Obere, hoch klappbare Halterung  
Untere, hoch klappbare Ablage mit Metallstreben und nicht abfärbende Abweisrollen Ø 100 mm  
Robuster, wasserabweisender PES-Wäschesack 127 Ltr. in bordeaux



**Complete set baby bed**  
Set composed by: pillowcase 38x57 cm, fitted sheet for cot 100x155 cm, sheet 120x170 cm  
**Set completo letto bimbo**  
Set composto da: lenzuolo da sopra misura 120x170 cm, lenzuolo da sotto con angoli misura totale 100x155 cm, federe sacchetto misura 38x57 cm

**Set complet pour lit bébé**  
Ensemble composé d'une taie d'oreiller 38x57 cm, drap housse pour lit bébé 100x155 cm, drap 120x170 cm  
**Komplettes Baby Bett Set**  
Set bestehend aus Kissenbezug 38x57 cm, Spannbetttuch für Kinderbett 100x155 cm, Blatt 120x170 cm

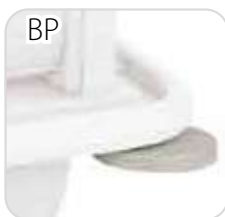

**4 additional donut bumpers on each of the trolley's corner**  
Soft, non-marking material  
Light-grey, RAL 9006  
**Kit paracolpi su ogni angolo del carrello**  
Materiale flessibile e antitraccia  
Colore grigio chiaro, RAL 9006

**4 pare-chocs annulaires d'angle sur chariot**  
Matériau souple et non-marquant  
Gris clair, RAL 9006  
**4 zusätzliche Abweiringe am Stoßschutz, Ø 90mm**  
Weiches, nicht abfärbendes Material  
Hellgrau, RAL 9006

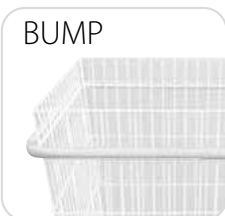

**Full wrap-around bumper**  
**Paracolpo perimetrale in gomma**

**Pare-chocs périmétrique en caoutchouc**  
**Oben umlaufender rundum Gummistoßschutz**



**Small items box, metal (without lid)**  
Adjustable separators made of HPL (size S=1pc. / size M=2pcs. / size L=3pcs.), height 10 cm  
Pre-punched for mechanical fixing into trolley top  
**Cassetta porta oggetti superiore in metallo senza coperchio**  
Separatori regolabili in HPL (1 nel modello S, 2 nel modello M, 3 nel modello L), 10 cm di altezza  
Preforata per il fissaggio sul carrello

**Casier à produits d'accueil métallique (sans couvercle)**  
Séparateurs ajustables en HPL (taille S: 1pc / taille M: 2 pcs / taille L: 3pcs), hauteur 10 cm  
Fond pré-percé pour fixation mécanique sur la galerie supérieur d'un chariot  
**Kleinartikelkasten aus Metall ohne Deckel**  
Variable Trennsteg aus HPL (Maße S=1 Stk. / Maße M = 2 Stk. / Maße L = 3 Stk.) Seitenhöhe 10 cm  
Vorgelocht für Verschraubung mit der obersten Ebene



**Small items metal box with lid**  
Adjustable separators made of HPL (size S=1pc. / size M=2pcs. / size L=3pcs.)  
Height 10cm  
Pre-punched for mechanical fixing into trolley top  
Handle with chrome finish, soft closing  
**Cassetta porta oggetti superiore in metallo con coperchio**  
Separatori regolabili in HPL (1 nel modello S, 2 nel modello M, 3 nel modello L)  
10 cm di altezza  
Preforata per il fissaggio sul carrello  
Maniglia cromata, cerniere idrauliche

**Casier à produits d'accueil métallique (avec couvercle)**  
Séparateurs ajustables en HPL (taille S: 1pc / taille M: 2 pcs / taille L: 3pcs)  
Hauteur 10 cm  
Fond pré-percé pour fixation mécanique sur la galerie supérieur d'un chariot  
Poignée chromée, fermeture amortie  
**Kleinartikelkasten aus Metall mit abschließbarem Deckel**  
Variable Trennsteg aus HPL (Maße S=1 Stk. / Maße M = 2 Stk. / Maße L = 3 Stk.)  
Seitenhöhe 10 cm  
Vorgelocht für Verschraubung mit der obersten Ebene  
Verchromter Handgriff



# OPTIONS | OPTIONEN



**Protective cover, individually made**  
 PVC coated fabric with robust structure  
 Various colours available  
 Optional logo printing  
**Copertura protettiva**  
 PVC, molto robusto  
 Diversi colori disponibili  
 Possibilità di aggiungere il logo

**Housse de protection**  
 Matériau PVC lisse renforcé, très robuste  
 Plusieurs coloris disponibles  
 Option impression logo  
**Hochwertige Schutzhülle, individuell angefertigt**  
 PVC beschichtetes Gewebe, sehr stabile Struktur  
 Verschiedene Farben zur Auswahl  
 Logo-Druck möglich



**Big drawer**  
 Drawer with inner Separators and shelf  
**Cassetto capiente**  
 Cassetto con separatori interni e ripiano estraibile

**Grand tiroir**  
 Tiroir avec séparateurs et étagère  
**Große Schublade**  
 Schublade mit Inneneinteilung und Regalboden



**Metal drawer**  
 Adjustable separators made of HPL  
 (size S=1pc. / size M=2pcs. / size L=3pcs.)  
 Sturdy metal rails  
 Soft closing  
 Integrated, mechanical pullout stop  
**Cassetto interno in metallo**  
 Separatori interni in HPL  
 (1 nel modello S, 2 nel modello M, 3 nel modello L)  
 Guide metalliche  
 Meccanismo di sicurezza contro le aperture accidentali

**Tiroir métallique**  
 Séparateurs ajustables en HPL  
 (taille S: 1pc / taille M: 2 pcs / taille L: 3pcs)  
 Glissières métalliques  
 Loquet fermeture tiroir amorti  
 Mécanisme de blocage anti-ouverture accidentelle  
**Metallschublade**  
 Variable Inneneinteilung aus HPL  
 (Maße S=1 Stk. / Maße M = 2 Stk. / Maße L = 3 Stk.)  
 Stabile Metall-Führungsschienen  
 Manuelle Verriegelung  
 Mechanischer Auszugstopp



**Small item box with 6 separators**  
 Adjustable separators made of HPL  
**Cassetta con 6 separatori in HPL**  
 Separatori regolabili in HPL

**Casier à produits avec 6 séparateurs**  
 Séparateurs ajustables en HPL  
**Kleinartikelkasten mit 6 Inneneinteilungen aus HPL**  
 Variable Trennstege aus HPL



**Drawer for Verso**  
 Removable stainless steel container  
**Bacinella estraibile per carrelli Verso**  
 Bacinella estraibile in acciaio inox

**Tiroir pour Verso**  
 Récipient amovible en acier inoxydable  
**Abnehmbarer Edelstahlbehälter für VERSO**



**Doors lockable in laminated wood**  
 Size S=1 door, size M=2 doors, size L=2 doors  
 Dormant lock, 2 keys  
 Upper magnetic latches  
**Chiusura con porte in legno laminato**  
 1 porta per il modello S, 2 porte per i modelli M e L  
 Maniglia inclusa nel meccanismo di chiusura, 2 chiavi  
 Fermi magnetici

**Portes verrouillables en bois mélaminé**  
 Taille S : 1 porte, taille M et L : 2 portes  
 Poignée et verrou encastrés et incrustés, 2 clés  
 Loquet magnétique supérieur  
**Türen, abschließbar melaminharzbeschichtetes Holz**  
 S=1 Türe, M=2 Türen, L=2 Türen  
 Flach versenktes Schloss, 2 Schlüssel  
 Obere Magnetarretierungen



**Selective waste sorting kit**  
 3 plastic containers  
 Lower liftable base with metal bars and 4 donut bumpers  
**Kit raccolta differenziata**  
 3 contenitori di plastica  
 Supporto inferiore ribaltabile con ruotine paracolpo

**Kit tri sélectif**  
 3 conteneurs en plastique  
 Support inférieur relevable avec barres métalliques anti-affaissement et pare-chocs annulaires d'angle  
**Selektives Abfallsortierkit**  
 3 Kunststoffbehälter  
 Untere, hoch klappbare Ablage mit Metallstreben und nicht abfärbende Abweisrollen Ø 100 mm



**e-DRIVE**  
Fifth motorized wheel (forward and backward) electrically operated by knob  
180w 24v electric motor with electromagnetic unlockable brake  
2 wheels polyurethane bandage diameter 160 mm  
2 batteries + charger + battery charge level indicator  
Control button box in painted plastic  
Made in France and Certificate of Integrability CE

**e-DRIVE**  
Quinta ruota motorizzata azionata elettricamente tramite manopola  
Motore elettrico 180w 24v con freno elettromagnetico sbloccabile  
2 ruote diametro 160 mm  
2 batterie + caricabatterie + indicatore livello carica batteria  
Pulsantiera di comando in plastica verniciata  
Prodotto in Francia e certificato di integrabilità CE

**e-DRIVE**  
Cinquième roue motorisée (avant et arrière) actionnée électriquement par bouton  
Moteur électrique 180w 24v, frein électromagnétique déverrouillable  
2 roues bandage polyuréthane diamètre 160 mm  
2 batteries + chargeur + voyant de niveau de charge des batteries  
Boite à boutons de commande en plastique peint  
Fabriqué en France et Certificat d'intégrabilité CE

**e-DRIVE**  
Fünftes motorisiertes Rad (vorwärts und rückwärts) elektrisch betätigt durch Knopf  
Elektromotor 180w 24v mit elektromagnetischem entriegelbarer Bremse  
2 Räder Polyurethan-Bandage Durchmesser 160 mm  
2 Batterien + Ladegerät + Ladezustandsanzeige  
Bedientastenbox aus lackiertem Kunststoff  
Made in France und Zertifikat der Integrierbarkeit CE



**E / R**  
**Shutter lockable**  
Upper snap closure, 2 keys  
**Chiusura scorrevole**  
Fermi magnetici, 2 chiavi

**Volet roulant verrouillable**  
Fermeture à bouton-pression, 2 clés  
**Kunststoff Rollo, abschließbar**  
Obere Magnetarretierungen, 2 Schlüssel



**EXB**  
**Extra base**  
Lower extensible-liftable base with metal bars and abrasion-proof, non-marking donut bumpers Ø 100 mm  
Maximum weight supported 10 kg  
**Extra base**  
Base allungabile e sollevabile inferiore con barre metalliche e antiabrasione, paraurti a ciambella antistraccia Ø 100 mm  
Peso massimo supportato 10 kg

**Base extensible**  
Support inférieur extensible-relevable avec barres anti-affaissement et 2 pare-chocs annulaires d'angle non marquants Ø 100 mm.  
Poids maximum supporté 10 kg  
**Zusätzliche Basis**  
Untere ausziehbar und anhebbare Basis in Metal und abriebfesten, nicht abfärbende Abweisinge Ø 100 mm  
Maximales unterstütztes Gewicht 10 kg



**GR**  
**Mesh shelf**  
Height adjustable mesh shelf  
**Ripiano in rete**  
Ripiano in rete regolabile in altezza

**Etagère en fil**  
Étagère en maille réglable en hauteur  
**Gitterrost**  
Höhenverstellbare Gitterablage



**KC**  
**Lock with combination**  
Chiusura con serratura con combinazione

**Verrou à combinaison**  
Abschließbares Zahlenschloss



**LID**  
**Lockable metal lid for top shelf, powder coated**  
Handle with chrome finish  
Adjustable separators made of HPL (S=1 pc. lengthwise, 1 depthwise / M=1 pc. lengthwise, 2 depthwise / L=1 pc. lengthwise, 3 depthwise)  
**Coperchio in metallo verniciato con serratura**  
Maniglia cromata  
Separatori regolabili in HPL (S= 1 sep. in larghezza e 1 in profondità, M= 1 sep. in larghezza e 2 in profondità, L= 1 sep. in larghezza e 3 in profondità)

**Capot métallique verrouillable intégré**  
Poignée chromée  
Séparateurs ajustables en HPL (1 pc. en longueur et en largeur: taille S: 1 pc / taille M: 2 pcs. / taille L: 3 pcs.)  
**Abschließbarer Metalldeckel für oberste Etage, pulverbeschichtet**  
Verchromter Handgriff  
Variable Inneneinteilung aus HPL (1 vertikaler, 1 senkrechter Trennsteg für S / 1 vertikaler, 2 senkrechte Trennstege für M / 1 vertikaler, 3 senkrechte Trennstege für L)



**LOGO**  
**Carpet with logo**  
Weaved in logo (in all colors, sizes and variations)  
Individual production  
**Moquette personnalisable**  
Possibilità di inserire il logo in qualsiasi colore, taglia e variante  
Produzione su misura

**Moquette avec logo**  
Logo avec taille et couleur au choix  
Production à la pièce  
**Teppich mit individuellem Logo**  
Eingewebtes Logo (in allen Farben, Maßen und Varianten)  
Individuelle Fertigung

# OPTIONS | OPTIONEN



**Belt with logo for Retrax**  
Weaved in logo (in all colors and variations)  
**Nastro personalizzabile per Retrax**  
Possibilità di inserire il logo in qualsiasi colore e variante

**Sangle avec logo pour Retrax**  
Logo avec taille et couleur au choix  
**Band mit individuellem Logo für Retrax**  
Eingewebtes Logo (in allen Farben und Varianten)



**Plaque with personalized logo**  
Possibility to customize the graphics  
**Placca con logo personalizzato**  
Possibilità di personalizzare la grafica

**Plaque avec logo personnalisé**  
Possibilité de personnaliser les graphiques  
**Werbepatte mit personalisiertem Logo**  
Möglichkeit zum Anpassen der Grafiken



**Sheathing made of synthetic leather**  
Available colors: red, blue and black  
Velcro fastener, height: 250 mm  
**Manopole in pelle sintetica**  
Disponibili in rosso, blu e nero  
Chiusura con velcro spessore 250 mm

**Manchons de préhension en cuir synthétique**  
Disponibles en rouge, bleu et noir  
Accroche velcro, hauteur: 250 mm  
**Griff-Ummantelung aus Kunstleder**  
Erhältlich Farben: Rot, Blau und Schwarz  
Klettverschluss, Höhe: 250 mm



**Additional foldable foam mattress**  
Dimensions: 120x 60x 6 cm  
Weight: 1 kg  
**Materassino extra pieghevole in schiuma**  
Dimensioni: 120x 60x 6 cm  
Peso: 1 kg

**Matelas en mousse pliable supplémentaire**  
Dimensions: 120x 60x 6 cm  
Poids: 1 kg  
**Zusätzliche faltbare Schaumstoff Matratze**  
Abmessungen: 120x 60x 6 cm  
Gewicht: 1 kg



**Neutral plate for Volo trolley**  
Dimensions: 400x h200 mm  
Optional logo printing  
**Placca per carrello porta bagagli Volo**  
Dimensioni: 400x h200 mm  
Possibilità di aggiungere il logo

**Plaque neutre pour VOLO**  
Dimensions: 400 xh200 mm  
Option impression logo  
**Werbepatte für Volo Trolley**  
Abmessungen: 400x h200 mm  
Logo-Druck möglich



**Bucket holder, powder coated**  
Lower, full steel base, dimension 354x566 mm LxW  
2 buckets, 12 Ltr. each (red and blue)  
2 bumpers Ø100 mm  
**Kit porta secchi**  
Supporto inferiore in acciaio, ribaltabile  
2 secchi da 12 Ltr. (uno rosso e uno blu)  
2 ruotine paracolpo Ø100 mm

**Porte-seaux finition peinte**  
Support seaux relevable en acier dimensions 354x566 mm LxW  
2 seaux de 12 Ltr. (rouge et bleu)  
2 pare-chocs annulaires d'angle Ø100 mm  
**Eimerhalterung, pulverbeschichtet**  
Untere Ablage aus Metall  
2 Eimer à 12 Ltr. (Rot und Blau)  
2 Abweisrollen Ø100 mm



**Waste bag holder, powder coated**  
Upper liftable holder  
Stable, black plastic lid with Caddie logo  
Lower liftable base with metal bars and abrasion-proof, non-marking donut bumpers Ø 100 mm  
**Kit sacco spazzatura**  
Supporto superiore ribaltabile  
Coperchio nero in plastica con logo Caddie  
Supporto inferiore ribaltabile con barre in metallo e ruote paracolpo antiruggine Ø100 mm

**Support sac à déchets**  
Support supérieur relevable  
Couvercle noir en plastique avec logo Caddie  
Support inférieur relevable avec barres anti-affaissement  
2 pare-chocs annulaires d'angle non marquants Ø100 mm  
**Müllsackhalterung, pulverbeschichtet**  
Obere, hoch klappbare Halterung  
Stabiler, schwarzer Kunststoff-Deckel mit Caddie Logo  
Untere, hoch klappbare Ablage mit Metallstreben und nicht abfärbende Abweisrollen Ø 100 mm

# OPTIONS | OPTIONALS

PVC / BDX



## Waste bag holder with mask bag, powder coated

Upper liftable holder  
Stable, black plastic lid with Caddie logo  
Water-repellent PES laundry bag (127 Ltr.) in burgundy red  
Lower liftable base with metal bars and abrasion-proof, non-marking donut bumpers Ø 100 mm

## Kit sacco spazzatura con sacco maschera BDX

Supporto superiore ribaltabile  
Coperchio nero in plastica con logo Caddie  
Sacco maschera bordeaux PES idrorepellente (127 Ltr.)  
Supporto inferiore ribaltabile con barre in metallo e ruote paracolpo antitraccia Ø100 mm

## Support sac à déchets avec sac de cache

Support supérieur relevable  
Couvercle noir en plastique avec logo Caddie  
Sac à linge hydrophobe très solide coloris bordeaux 127 Ltr.  
Support inférieur relevable avec barres anti-affaissement  
2 pare-chocs annulaires d'angle non marquants Ø100 mm

## Müllsackhalterung, pulverbeschichtet, mit BDX-

Sichtschutzsack  
Obere, hoch klappbare Halterung  
Stabiler, schwarzer Kunststoff-Deckel mit Caddie Logo  
Bordeaux-farbener, robuster BDX-Sichtschutzsack (127 Ltr.)  
Untere, hoch klappbare Ablage mit Metallstreben und nicht abfärbende Abweisrollen Ø 100 mm

PVC-PSE



## Waste bag holder, powder coated

Upper liftable holder  
Stable, black plastic lid with Caddie logo  
Lower, full steel base, dimension 354x566 mm LxW  
2 buckets, 12 Ltr. each (red and blue)

## Kit sacco spazzatura

Supporto superiore ribaltabile  
Coperchio nero in plastica con logo Caddie  
Supporto inferiore in acciaio, ribaltabile  
2 secchi da 12 Ltr. (uno rosso e uno blu)

## Support sac à déchets

Support supérieur relevable  
Couvercle noir en plastique avec logo Caddie  
Support seaux relevable en acier dim. 354x566 mm LxW  
2 seaux de 12 Ltr. (rouge et bleu)

## Müllsackhalterung, pulverbeschichtet

Obere, hoch klappbare Halterung  
Stabiler, schwarzer Kunststoff-Deckel mit Caddie Logo  
Untere Ablage aus Metall  
2 Eimer à 12 Ltr. (Rot und Blau)

PVC/SAC



## Holders for waste sorting kit with 1 bag and mask bag

Upper liftable holder equipped for 1 bag  
Stable, black plastic lid with Caddie logo  
Suspension stirrup made of metal with 1 rubber bands for fixing the waste bag  
Grey laundry bag (127 Ltr.) used as mask bag

## Kit 1 sacco spazzatura con sacco maschera

Supporto superiore ribaltabile  
Coperchio nero in plastica con logo Caddie  
Sacco in poliestere grigio 127 Ltr. con chiusura a cordoncino  
Supporto inferiore ribaltabile con barre in metallo e ruote paracolpo antitraccia Ø100 mm

## Support sac à déchets pour tri à 1 sacs avec sac de cache

Support supérieur relevable  
Couvercle noir en plastique avec logo Caddie  
Support inférieur relevable avec barres anti-affaissement et 2 pare-chocs annulaires d'angle non marquant Ø 100 mm  
Sac à linge gris 127 Ltr.

## 1 geteilte Müllsackhalterung, mit Sichtschutzsack

Obere, hoch klappbare Halterung  
Stabiler, schwarzer Kunststoff-Deckel mit Caddie Logo  
Anthrazit Polyester-Wäschesack mit Kordelzug, 127 Ltr.  
Untere, hoch klappbare Ablage mit Metallstreben und nicht abfärbende Abweisrollen Ø 100 mm

PVC2



## Waste bag holder for 2 bags, powder coated for Tahiti and Palacenet

Upper liftable holder  
Stable, black plastic lid with Caddie logo  
Suspension stirrup made of metal with 2 rubber bands for fixing of the waste bags  
Bumpers Ø100 mm

## Kit 2 sacchi spazzatura per Tahiti e Palacenet

Supporto superiore ribaltabile  
Coperchio nero in plastica con logo Caddie  
Supporto inferiore ribaltabile con barre in metallo e ruote paracolpo antitraccia Ø100 mm

## Support sac à déchets pour tri à 2 sacs pour Tahiti et Palacenet

Support supérieur relevable intégrant 2 anneaux de fixation ayant chacun un élastique pour maintenir un sac.  
Couvercle noir en plastique avec logo Caddie  
Support inférieur relevable avec barres anti-affaissement et 2 pare-chocs annulaires d'angle non marquant Ø100 mm

## 2 geteilte Müllsackhalterung, pulverbeschichtet für Tahiti und Palacenet

Obere, hoch klappbare Halterung  
Stabiler, schwarzer Kunststoff-Deckel mit Caddie Logo  
Untere, hoch klappbare Ablage mit Metallstreben und nicht abfärbende Abweisrollen Ø 100 mm

PVC2/SAC



## Holders for waste sorting kit with 2 bags and mask bag for Tahiti and Palacenet

Upper liftable holder equipped for 2 bags  
Stable, black plastic lid with Caddie logo  
Suspension stirrup made of metal with 2 rubber bands for fixing the waste bags  
Grey laundry bag (127 Ltr.) used as mask bag

## Kit 2 sacchi spazzatura con sacco maschera per Tahiti e Palacenet

Supporto superiore ribaltabile  
Coperchio nero in plastica con logo Caddie  
Sacco in poliestere grigio 127 Ltr.  
Supporto inferiore ribaltabile con barre in metallo e ruote paracolpo antitraccia Ø100 mm

## Support sac à déchets pour tri à 2 sacs avec sac de cache pur Tahiti et Palacenet

Support supérieur relevable prévue pour le maintien de 2 sacs grâce à 2 élastiques (fournis)  
Couvercle noir en plastique avec logo Caddie  
Support inférieur relevable avec barres anti-affaissement et 2 pare-chocs annulaires d'angle non marquant Ø100 mm  
Sac à linge polyester avec cordelette, 127 Ltr.

## 2 geteilte Müllsackhalterung, mit Sichtschutzsack für Tahiti und Palacenet

Obere, hoch klappbare Halterung  
Stabiler, schwarzer Kunststoff-Deckel mit Caddie Logo  
Anthrazit Polyester-Wäschesack mit Kordelzug, 127 Ltr.  
Untere, hoch klappbare Ablage mit Metallstreben und nicht abfärbende Abweisrollen Ø 100 mm

# OPTIONS | OPTIONEN

RF



Upgrade for 2 wheels with brake

Supplemento per 2 ruote con freno

Option 2 roulettes fixes et 2 roulettes pivotantes à frein.

Aufpreis für 2 Bremsrollen

RG



Upgrade for 4 superelastic swivel wheels, 2 with brake, it is not possible to mount the option RS5 with RG

Supplemento per 4 ruote super elastiche Ø200 mm di cui due con freno, optional non compatibile con RS5

Option 4 roues superelastiques pivotantes Ø200 mm dont 2 à frein.

4 Soft-Lenkrollen Ø200 mm, davon 2 Bremsrollen Montage der Option RS5 nicht möglich

RGI



Upgrade for 4 swivel wheels Ø200 mm without brakes

Supplemento per 4 ruote super elastiche Ø200 mm girevoli

Option 4 roues pivotantes Ø200 mm sans frein

Aufpreis für 4 Soft-Lenkrollen Ø200 mm

RGB



Upgrade for 4 superelastic wheels Ø200 mm: 2 swivel with brake, 2 fixed wheels

It is not possible to mount the option RS5 with RGB  
Supplemento per 4 ruote super elastiche Ø200 mm di cui due fisse e due con freno  
Optional non compatibile con RS5

Option 4 roues Ø200mm superelastiques : 2 pivotantes avec frein, 2 fixes

Avec RGB ce n'est pas possible de monter l'option RS5  
Aufpreis für 2 Soft Lenk- und 2 Bockrollen Ø200 mm, davon 2 Bremsrollen  
Montage der Option RS5 nicht möglich

RNY



Upgrade for 4 nylon swivel wheels, 2 with brake

Ideal for carpeted floors  
Wheel made of nylon Ø160 mm

Supplemento per 4 ruote Nylon di cui 2 con freno  
Ideali per moquette  
Ruota in nylon Ø160 mm

Option 4 roulettes nylon pivotantes dont 2 à frein

Pour sol en moquette souple  
Roulette avec bandage dur nylon Ø160 mm

Aufpreis für 4 Nylon-Lenkrollen, davon 2 Bremsrollen  
Geeignet für tiefe, hochflorige Teppichböden  
Rolle aus Nylon Ø160 mm

RNYI



Upgrade for 4 nylon swivel wheels, without brake

Ideal for carpeted floors  
Wheel made of nylon Ø160 mm

Supplemento per 4 ruote Nylon girevoli  
Ideali per moquette  
Ruota in nylon Ø160 mm

Option 4 roulettes nylon pivotantes sans frein

Pour sol en moquette souple  
Roulette avec bandage dur nylon Ø160 mm

Aufpreis für 4 Nylon-Lenkrollen  
Geeignet für tiefe, hochflorige Teppichböden  
Rolle aus Nylon Ø160 mm

RNYB



Upgrade for 4 nylon wheels, and 2 fixed, 2 swivel with brake

Ideal for carpeted floors  
Wheel made of nylon Ø160 mm

Supplemento per 4 ruote in Nylon di cui 2 fisse e 2 girevoli con freno  
Ideali per moquette  
Ruota in nylon Ø160 mm

Option 4 roulettes nylon dont 2 fixes, 2 pivotantes avec frein

Pour sol en moquette profonde  
Roulette avec bandage dur nylon Ø160 mm

Aufpreis für 4 Nylon-Lenk-Blockrollen, davon 2 Bremsrollen  
Geeignet für tiefe, hochflorige Teppichböden  
Rolle aus Nylon Ø160 mm

RS



Upgrade for 4 nylon wheels, and 2 fixed, 2 swivel

4 wheels (2 fixed and 2 swivel castors).  
Sturdy and silent Nylon wheels.  
Big 110 mm rear wheels, small 50 mm front wheels.

Supplemento per 4 ruote in nylon di cui 2 fisse e 2 girevoli

4 ruote (2 ruote fisse e 2 ruote girevoli).  
Ruote in Nylon robuste e silenziose. Grandi ruote posteriori da 110 mm, piccole ruote anteriori da 50 mm

Option 4 roulettes nylon dont 2 fixes, 2 pivotantes

4 roues en nylon. Roues arrières Ø 100 mm, et roues avant Ø 50mm.

Aufpreis für 4 Nylon-Lenk-Blockrollen  
Robuste und leise Nylonrollen mit Doppelkugellagern  
Hinterrad Ø 100 mm, Bockrollen  
Vorderrad Ø50 mm, Lenkrollen

# OPTIONS | OPTIONALS



**RS5**  
**Additional fifth wheel (only for trolley size M and L), Ø100 mm**  
 Centrally mounted for more stability and an improved handling when fully loaded  
 Rubber tread  
**Quinta ruota centrale (solo per modelli M e L) Ø100 mm**  
 Montata al centro del carrello, maggiore stabilità e gestione anche a pieno carico  
 Rivestimento in gomma

**5ème roue centrale additionnelle (seulement sur chariot taille M et L) Ø100 mm**  
 Montage central pour plus de stabilité et une maniabilité améliorée en charge  
 Bandage caoutchouc  
**Fünfte, zusätzliche Rolle (nur für M & L Maßen), Ø100 mm**  
 Mittig montiert für zusätzliche Stabilität und leichtere Manövrierbarkeit Gummilauffläche im beladenen Zustand

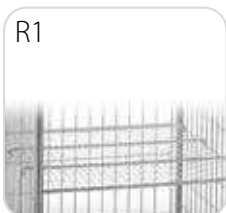

**R1**  
**Removable shelf for roll container, electrolytically galvanized**  
 Dimensions LxW in mm: 625x724, unit weight: 3,5 kg  
 Mesh dimensions: 60x130 mm  
**Ripiano amovibile per roll container in filo d'acciaio zincato**  
 Dimensioni LxW 625x724, peso 3,5 kg  
 Dimensione della maglia 60x130 mm

**Etagère amovible pour container roll en fil d'acier soudé et électro-galvanisé**  
 Dimensions LxL en mm: 625x724, poids : 3,5 kg  
 Dimensions des mailles en mm: 60x130  
**Elektrolytisch verzinktes Einlegegitter**  
 Maße LxB mm: 625x724, Gewicht: 3,5 kg  
 Maschenweite 60x130



**SAC**  
**Laundry bag holder, powder coated**  
 Upper liftable holder  
 Lower liftable base with metal bars and abrasion-proof, non-marking donut bumpers Ø 100 mm  
 Polyester laundry bag with drawstring (127 Ltr.)  
**Kit sacco biancheria poliestere**  
 Supporto superiore ribaltabile  
 Supporto inferiore ribaltabile con barre in metallo e ruote paracolpo antiraccia Ø100 mm  
 Sacco biancheria in poliestere grigio con chiusura a cordoncino (127 Ltr.)

**Support Sac à linge**  
 Support supérieur relevable  
 Support inférieur relevable avec barres anti-affaissement et 2 pare-chocs annulaires d'angle non marquant Ø100 mm  
 Sac à linge polyester avec cordelette, 127 Ltr.  
**Wäschesackhalterung, pulverbeschichtet**  
 Obere, hoch klappbare Halterung  
 Untere, hoch klappbare Ablage mit Metallstreben und nicht abfärbende Abweisrollen Ø 100 mm  
 Anthrazit Polyester-Wäschesack mit Kordelzug, 127 Ltr.



**SAC-B**  
**Laundry bag, powder coated**  
 Polyester laundry bag with drawstring (50 Ltr.)  
**Kit sacco biancheria poliestere**  
 Sacco biancheria in poliestere grigio con chiusura a cordoncino (50 Ltr.)

**Sac à linge**  
 Sac à linge polyester avec cordelette, 50 Ltr.  
**Wäschesack**  
 Anthrazit Polyester-Wäschesack mit Kordelzug, 50 Ltr.



**SATELLITE**  
**Removable trolley with waste bag and cover, used either alone or connected to the BALI trolley**  
 Steel tube frame  
 Clip-on system for BALI  
 2 fixed castors  
**Carrello rimovibile con sacco per rifiuti e coperchio, usato da solo o collegato al carrello BALI**  
 Telaio in tubo d'acciaio  
 Sistema a clip per BALI  
 2 ruote fisse

**Chariot détachable avec sac poubelle et couvercle, utilisé seul ou connecté au chariot BALI**  
 Cadre en tube d'acier  
 Système à clipser pour BALI  
 2 roulettes fixes  
**Abnehmbarer Müll- oder Wäschewagen mit Sichtschutz, einzeln verwendbar oder verbunden mit BALI**  
 Stahlrohrrahmen  
 Andocksystem für BALI  
 2 Bockrollen



**SE**  
**SE-Bucket of 12 L.**  
 2 buckets, 12 Ltr. each (red and blue)  
**Secchio SE da 12 L.**  
 2 secchi da 12 Ltr. ciascuno (rosso e blu)

**SE-Seau de 12L.**  
 2 seaux de 12 Ltr. (rouge et bleu)  
**Eimer Kunststoff**  
 2 Eimer à 12 Ltr. (rot und blau)



**S/H**  
**Protection frame for ALTO 2 and ALTO ICE 3**  
**Spondine cromate per ALTO 2 e ALTO ICE 3**

**Cadre de protection pour ALTO 2 et ALTO ICE 3**  
**Schutzreling für ALTO 2 und ALTO ICE 3**

# OPTIONS | OPTIONEN



**T**  
**Compartment pocket, grey**  
 2 bigger pockets (approx. 22\*21cm)  
 2\*3 middle size, transparent pockets (approx. 14\*21cm)  
 Fixation to the upper holder by velcro loops and additional velcro strips on rear  
**Tasca a 8 scompartimenti**  
 2 ampie tasche (circa 22x21 cm)  
 6 tasche trasparenti di medie dimensioni (circa 14x21 cm) disposte su due livelli  
 Fissata al carrello tramite velcro



**TL**  
**Tool box**  
 Handy tool box with grip  
 Material: Polypropylene copolymer  
 Dimensions: Height (with handle) 26 cm, Width 29 cm, Length 33 cm; Single drawers 10x30x14 cm  
**Tool box**  
 Cassetta multiscoperto con impugnatura  
 Materiale: copolimero di polipropilene  
 Misure: altezza (con manico) 26 cm, larghezza 29 cm, lunghezza 33 cm; Cassetti singoli 10x30x14 cm



**TRF**  
**New pedal-twin-brake system, activating 2 brakes at once**  
**Nuovo sistema di freno a pedale che permette di bloccare due ruote contemporaneamente**



**UK**  
**UK plug**  
 UK format plug  
**Preso UK**  
 Presa formato Britannico



**V CLIP**  
**Vacuum clip**  
 One vacuum clip, possibility to add more clips  
**Clip per aspirapolvere**  
 Clip per scopa, possibilità di aggiungere altre



**VH**  
**Vacuum cleaner holder, powder coated**  
 Lower liftable, full steel base with retaining bar  
 Donut bumpers on each corner Ø100 mm  
 Upper holder 340 L x 370 D  
**Kit porta aspirapolvere**  
 Supporto inferiore con barre in metallo  
 Ruote paracolpo antiraccia Ø100mm  
 Supporto inferiore 340 L x 370 D



**000LID**  
**Lid**  
 Hardtop lid for Handie  
**Chiusura superiore rigida**  
 Chiusura superiore rigida per Handie



**CAD00069**  
**Coin lock**  
 Unlock system for luggage trolley Volo and Volo GR Incl: chain with key.  
**Coin lock**  
 Sistema di sblocco per carrello portabagagli Volo e Volo GR. Incl: catena con chiave.

**Sac gris 8 compartiments**  
 2 grandes poches (approx. 22\*21cm)  
 2 niveaux de 3 poches transparentes (approx. 14x21cm)  
 Fixation latérale sur chariot avec vélcro  
**Kleinartikel-Tasche aus Kunststoff, grau**  
 2 größere Kunststoffächer (ca. 22x21cm)  
 2 x 3 mittlere, transparente Taschen (ca. 14x21cm)  
 Befestigung mittels Klettverschluss-Schlaufe an oberer Halterung sowie Klettverschluss-Streifen auf Rückseite

**Boîte à rangement**  
 Boîte à outils manuelle avec poignée  
 Matériau: Copolymère de polypropylène  
 Mesures: Hauteur (avec poignée) 26 cm, Largeur 29 cm, longueur 33 cm; Compartements simples 10x30x14 cm  
**Flaschen- und Mehrweckkasten**  
 Handlicher Behälter mit Griff  
 Material: Polypropylen-Copolymer  
 Maße: Höhe (mit Griff) 26 cm, Breite 29 cm, Länge 33 cm  
 Einzelfach 10x30x14 cm

**Nouveau système »twin brake« permettant d'activer 2 freins en même temps avec une pédale**

**Pedal-Twin-Bremssystem, aktiviert 2 Bremsen gleichzeitig**

**Prise britannique**  
 Prise format GB  
**UK-Stecker**  
 UK-Format Stecker

**Clip aspirateur**  
 Possibilité d'en ajouter plusieurs  
**Besenclip**  
 Kunststoff Besenhalter

**Support aspirateur**  
 Support inférieur relevable  
 Pare-chocs annulaires d'angle Ø100 mm  
 Support supérieur 340 L x 370 P  
**Staubsaugerhalterung, pulverbeschichtet**  
 Untere, hoch klappbare Ablage aus Metall und nicht abfärbende Abweisrollen Ø100 mm  
 Oberer, hoch klappbarer Haltebügel 340 L x 370 D

**Couvercle rigide**  
 Couvercle rigide pour Handie  
**Verstärkte Abdeckung für Handie**

**Consigneur**  
 Consigne pour pièce de 1 EURO compatible avec chariot Volo et Volo GR. Incl: chaîne avec clé  
**Münzschloss**  
 Entriegelungssystem für Gepäckwagen Volo und Volo GR. Inklusive: Kette mit Schlüssel.

# PANEL FINISH | FINITURE



## HPL

High pressure laminate  
Pannelli in HPL

Panneaux HPL / laminé haute pression  
Hochdruck Schichtholzplatten



**SFB**  
Fabric  
Tessuto  
Tissu  
Stoff-Optik



**SOM**  
Elm  
Olmo  
Orme  
Ulme



**SWE**  
Wenge  
Wenge  
Wenge  
Wenge



**SNE**  
Cliff  
Scogliera  
Falaise  
Fels-Optik



## LAM

Laminated wood structure  
Pannelli in legno laminato

Panneaux bois mélaminés  
Melaminharzbeschichtetes Holz



**LNO**  
Walnut  
Noce  
Noyer  
Nussbaum



**LWE**  
Wenge  
Wenge  
Wenge  
Wenge



**LAN**  
Anthracite  
Antracite  
Antracite  
Anthrazit



**LNE**  
Fog  
Nebbia  
Brouillard  
Nebel



**LNV**  
Veined black  
Nero venato  
Noir Veiné  
Schwarz



**LBE**  
Birch  
Betulla  
Bouleau  
Birke



**LWS**  
White sand  
Sabbia bianca  
Sable blanc  
Weißer Sand



**LOM**  
Elm  
Olmo  
Orme  
Ulme



**LBV**  
Veined white  
Bianco venato  
Blanc veiné  
Weiß



**LTR**  
Travertine  
Travertino  
Travertin  
Travertin



**LCO**  
Corten  
Corten  
Corten  
Cortenstahl





## SWS

Solid wood structure  
Pannelli in legno massello

Panneaux bois massif  
Massivholz



**MNO**  
Walnut  
Noce  
Noyer  
Nussbaum

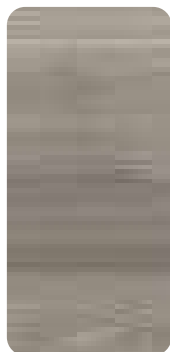

**MGR**  
Veined grey  
Grigio venato  
Gris veiné  
Grau marmoriert



**MWE**  
Wenge  
Wenge  
Wenge  
Wenge



**RAL**



## Passepartout

Laminated wood structure  
Pannelli in legno laminato

Panneaux bois mélaminés  
Melaminharzbeschichtetes Holz

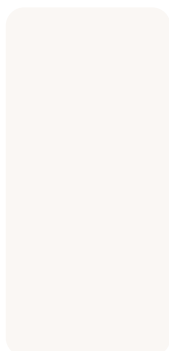

**PWH \***  
White  
Bianco  
Blanc  
Weiß

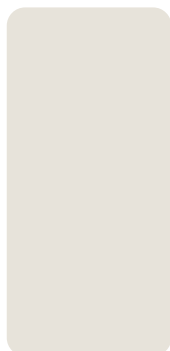

**PLG \***  
Light grey  
Grigio chiaro  
Gris clair  
Lichtgrau



**PMB**  
Metal Black  
Nero Metallico  
Noir métallique  
Metallschwarz



**PBE**  
Beech  
Faggio  
Hêtre  
Buche



**PCW \***  
Cherry wood  
Ciliegio  
Cerisier  
Kirschbaum



**PNO \***  
Walnut  
Noce  
Noyer  
Nussbaum



**PMA \***  
Mahogany  
Mogano  
Acajou  
Mahagoni



**PWE**  
Wenge  
Wenge  
Wenge  
Wenge



**PDO \***  
Dark oak  
Rovere moro  
Chêne foncé  
Mooreiche

\* Colors available on request starting from a minimum of order of 10 pieces.

\* Colori disponibili su richiesta a partire da 10 pezzi MOQ.

\* De nombreux coloris sont disponibles à partir de 10 pièces.

\* Weitere Farben sind bereits ab einer Mindestbestellmenge von 10 Stück auf Anfrage erhältlich.

**Buddie / Buddie Bar**

BK  
Black  
Nero  
Noir  
Schwarz



BR  
Brown  
Marrone  
Marron  
Braun



BL  
Blue  
Blu  
Bleu  
Blau



RE  
Red  
Rosso  
Rouge  
Rot



RAL  
Many other colors available on request starting from a minimum of order of 15 pieces.  
Molti altri colori sono disponibili su richiesta a partire da 15 pezzi MOQ.  
De nombreux autres coloris sont disponibles à partir de 15 pièces.  
Weitere Farben sind bereits ab einer Mindestbestellmenge von nur 15 Stück auf Anfrage erhältlich.

**Moquette**

Black  
Nero  
Noir  
Schwarz



Grey  
Grigio  
Gris  
Grau



Blue  
Blu  
Bleu  
Blau



Red  
Rosso  
Rouge  
Rot

Different shade of colour between polyamide and polypropylene carpets  
Sfumature di colore differenti tra le moquette in polipropilene e poliammide  
Nuances de couleur différentes entre la moquette en polyamide et polypropylène  
Unterschiedlicher Farbton zwischen Polyamid- und Polypropylenteppichen

Horizontal lines for writing.





Hospitality Excellence since 1928

The images reproduced in this catalogue are indicative. The manufacturer reserves the right to make technical, aesthetic and dimensional changes on the materials and models presented without prior notice. Weights, Dimensions, etc. are simply provided as an indication and do not bind the manufacturer. All the aforementioned differences are not such as to significantly modify the products themselves and do not constitute a reason for returning or replacing the goods or contesting variations in the volume of shipments.

Finally, the following edition replaces each previous edition.

Le foto riprodotte in questo catalogo sono indicative per le inevitabili differenze dovute alla riproduzione tipografica. Il costruttore si riserva il diritto di apportare modifiche tecniche, estetiche e dimensionali e su i materiali e modelli presentati senza preavviso. I pesi, le misure, ecc., sono semplicemente forniti a titolo indicativo e non impegnano il costruttore. Tutte le differenze sopraindicate non sono tali da modificare significativamente i prodotti stessi e non costituiscono motivo di reso o sostituzione della merce o di contestazione per variazioni nel volume delle spedizioni.

Infine la seguente edizione va a sostituire ogni edizione antecedente.

Les photos reproduites dans ce catalogue sont indicatives des différences inévitables dues à la reproduction typographique. Le fabricant se réserve le droit d'apporter des modifications techniques, esthétiques et dimensionnelles ainsi que sur les matériaux et modèles présentés sans préavis. Les poids, mesures, etc. sont simplement fournis à titre indicatif et ne lient pas le fabricant. Toutes les différences mentionnées ne modifient pas de manière significative les produits eux-mêmes et ne constituent pas un motif de retour ou de remplacement des marchandises ou de contestation pour variation du volume des expéditions. Enfin, l'édition présente remplace chaque édition précédente.

Die in diesem Katalog wiedergegebenen Fotos sind indikativ wegen der Unterschiede aufgrund typografischer Reproduktion. Der Hersteller behält sich das Recht vor, technische, ästhetische und maßliche Änderungen an den vorgestellten Materialien und Modellen ohne vorherige Ankündigung vorzunehmen. Gewichte, Maße usw. dienen lediglich als Anhaltspunkt und sind für den Hersteller nicht verbindlich. Alle oben genannten Unterschiede bewirken keine wesentlichen Änderungen der Produkte selbst und sind kein Grund für die Rücksendung oder den Umtausch der Waren oder für beanstandete Abweichungen im Sendungsvolumen. Schließlich ersetzt die folgende Ausgabe jede vorherige Ausgabe.

**Caddie Hotel Srl**  
**International Headquarter**

Via della Costiera 6/8  
IT-20010 Buscate  
Italy

Via Industria 33/35  
IT-20080 Albairate  
Italy

T: +39 02 94 06 578  
info@caddie-hotel.com

**Caddie Hotel GmbH**  
Albertstr. 2-6  
D-73054 Eisingen  
Germany

T: +49 (0)71 61 98 81 255  
F: +49 (0)71 61 98 30 946  
info@caddie-hotel.de  
www.caddie-hotel.de

V.1 © Caddie Hotel Srl 2022



[www.caddie-hotel.com](http://www.caddie-hotel.com)

Hospitality Excellence since 1928