

**PADERNO®**

WORLD CUISINE

[WWW.PADERNO.IT](http://WWW.PADERNO.IT)

CATALOGUE **2022**

PARTNER OF THE BEST CUISINE







COVER  
MICHELIN-STARRED CHEF ALFREDO RUSSO

DOLCE STIL NOVO ALLA REGGIA - VENARIA REALE



## MADE TO SHINE

Paderno has always been by professionals' side, so that the "star" in each of them can finally "shine". This is the philosophy behind the new brand communication campaign, a fascinating storytelling made of competence and passion where – in the spotlight – the excellence of Paderno's product range cannot miss.

Every day in the kitchen is a challenge, in which you have to manage space, time and tools. Paderno Made to Shine reveals the magic of those moments, with a flawless cooking performance by a Michelin-starred chef or with the show by a flair bartender during a mixology event. Discover all the contents on the website and social media, share them and join the Paderno community.

Professionals at the service of professionals.

LADIES AND GENTLEMEN,  
LET THE SHOW BEGINS!

Paderno è da sempre al fianco di tutti professionisti, affinché la "stella" presente in ciascuno di loro possa finalmente "splendere". Questa la filosofia dalla quale prende vita la nuova campagna di comunicazione del marchio, un affascinante storytelling di competenza e passione dove – sotto i riflettori – non può mancare l'eccellenza della gamma prodotti Paderno.

In cucina ogni giorno è una sfida, nella quale occorre gestire spazi, tempi e strumenti. Paderno Made to Shine svela la magia di quei momenti, dalla rigorosa performance ai fornelli di uno chef stellato, allo spettacolare show di un barman acrobatico durante un evento mixology. Scoprite tutti i contenuti sul sito e sui canali social, condivideteli ed entrate nella community Paderno.

Professionisti al servizio dei professionisti.

SIGNORE E SIGNORI,  
HA INIZIO LO SPETTACOLO!

## VIDEO PERFORMANCE



[www.paderno.it](http://www.paderno.it)





# Factory

**A COMPLETE RANGE FOR EVERY NEED IN THE KITCHEN.  
MORE THAN 10.000 ITEMS DEDICATED TO CHEFS AND  
PASSIONATE GOURMANDS.**

From the cookware to the kitchen utensils, then knives, bakery items and tools for every kind of preparation, Paderno offers a complete selection for the best kitchens of houses and restaurants. A brand that finds its origins back in 1925 in Milan as "Alluminio Paderno", specializing in household cookware before it decided to focus on the professional cooking world. With over 90 years of history and a strong worldwide presence, Paderno is the premier choice for professionals in the catering sector. In addition to the production items, the brand offers a remarkable range of complementary articles, carefully selected and crafted by highly qualified companies.

**UNA GAMMA COMPLETA PER OGNI ESIGENZA IN CUCINA.  
OLTRE 10.000 ARTICOLI COMPONGONO L'OFFERTA  
DEDICATA A CHEF E APPASSIONATI GOURMET.**

Dal pentolame agli utensili cucina, passando per coltelli, articoli da pasticceria e strumenti per ogni tipo di preparazione, Paderno offre una selezione completa per le migliori cucine di case e ristoranti. Il Brand trova le sue origini nel 1925 nei pressi di Milano come Alluminio Paderno, specializzato nel settore della cucina casalinga per poi passare al settore professionale. Forte di oltre 90 anni di storia e di una presenza capillare in tutto il mondo, Paderno è il punto di riferimento per tutti i professionisti della ristorazione. Agli articoli di produzione il brand affianca un'importante gamma di prodotti complementari e affini, accuratamente selezionati e realizzati da ditte altamente qualificate.



## **Ho.Re.Ca.**

T 0321 19 16 601  
F 0321 19 16 890

[horeca@paderno.it](mailto:horeca@paderno.it)  
[horeca@sambonet.it](mailto:horeca@sambonet.it)

## **Retail**

T 0321 19 16 701  
F 0321 19 16 830

[retail.italia@sambonet.it](mailto:retail.italia@sambonet.it)  
[retail.international@sambonet.it](mailto:retail.international@sambonet.it)

## **Return**

T 0321 19 16 635 - 759

[returns@sambonet.it](mailto:returns@sambonet.it)

[www.paderno.it](http://www.paderno.it)





# Green & Human

The respect for the environment and for the people is a relevant issue for Sambonet Paderno Industrie S.p.A. Corporate Responsibility. The commitment to sustainable growth on which the Group was founded has been maintained and permits both to guarantee adequate working conditions in order to satisfy the changing needs of the staff and to apply solutions aimed at reducing the environmental impact. From this perspective, the management of energy, electricity and water consumption focuses on:

- the use of electrical energy: clean, renewable and in harmony with the environment;
- the use of methane as the sole fuel source;
- the use of ground water for the manufacturing process, to be fully purified before being released into the environment;
- the use of an advanced energy-saving technology.

## Sustainability Report

Sambonet Paderno Industrie S.p.A. strives to implement forms of measurement to assess the punctuality, the transparency and the efforts made for sustainable development. This has led to the preparation of the corporate charter of principles, 10 principles, 10 commitments, on which the Company builds its industrial future from a perspective based on preventive approach and stewardship.

### Corporate Sustainability Report

[corporate.sambonet.it/csr.html](http://corporate.sambonet.it/csr.html)

The **UNI EN ISO 14001:2004** environmental certification is the recognition that the environmental policy results in a continuous improvement of environmental performance by minimising the negative impact of its operations on the environment.

The voluntary compliance with the standard **UNI EN ISO 50001:2011** demonstrates the company's commitment and vision towards responsible energy consumption, factoring in both the economic hope of reducing consumption and, above all, the desire to increase environmental awareness about reducing greenhouse gas emissions.

The **OHSAS 18001:2007** safety certification has the objective of protecting the safety of the workplace and the health of workers. Sambonet Paderno Industrie S.p.A. is the first Italian company in its sector that has obtained this certification.

## Social Responsibility

Sustainability, transparency and interaction with stakeholders are the integral components that the Corporate Social Responsibility policy of Sambonet Paderno Industries S.p.A. are comprised of.

The company's requirements, commitment and path taken in this area led it to obtain an SR10 certification in 2016 - the first in the sector. This important goal represents an objective guarantee in terms of attention in the interaction with stakeholders such as employees, customers, suppliers, local communities and associations in the area.

## WHP Health Promoting Workplace

This socially responsible role has recently prompted the company to join the European Network for Health Promoting Workplace (WHP), establishing itself as one of the pioneers of its territory. The project foresees that the company not only implements all the measures to prevent accidents and illnesses in the workplace but - and above all - that it also undertakes to offer its workers opportunities to improve their health, through the promotion of a wholesome lifestyle mentally, physically and emotionally.

Il rispetto dell'ambiente e della persona sono temi rilevanti all'interno della responsabilità d'impresa di Sambonet Paderno Industrie S.p.A. Il Gruppo ha impostato e sviluppa tutt'oggi la propria evoluzione con un impegno di crescita sostenibile garantendo condizioni lavorative che possano soddisfare i bisogni delle persone nei differenti momenti della loro vita aziendale e applicando soluzioni volte a diminuire l'impronta ecologica. In quest'ottica, la gestione dei consumi energetici, elettrici e idrici è orientata a:

- impiegare energia elettrica pulita e rinnovabile;
- utilizzare il metano come unica fonte di combustibile;
- servirsi, per la produzione, di acqua di falda da restituire all'ambiente completamente depurata;
- usare tecnologia di risparmio energetico avanzata.

Sambonet Paderno Industrie S.p.A. lavora per attuare forme di misurazione che siano in grado di documentare la puntualità, la trasparenza e l'impegno messo in atto per uno sviluppo sostenibile. Da qui la creazione della propria carta dei principi, 10 principi, 10 impegni su cui, attraverso un approccio preventivo e una gestione responsabile, l'Azienda costruisce il proprio futuro industriale.

### Bilancio di Sostenibilità dell'Azienda

[corporate.sambonet.it/csr.html](http://corporate.sambonet.it/csr.html)

**UNI EN ISO 14001:2004** La certificazione ambientale garantisce i risultati di una politica ambientale volta al continuo miglioramento delle proprie performance minimizzando ogni impatto negativo delle sue attività verso l'ambiente.

**UNI EN ISO 50001:2011** L'adesione volontaria alla norma UNI EN ISO 50001:2011 testimonia l'impegno e la visione dell'azienda verso l'ottimizzazione del consumo responsabile dell'energia, sia in termini economici auspicando a una riduzione dei consumi, e soprattutto verso una crescente attenzione ambientale diminuendo le emissioni di gas serra.

**OHSAS 18001:2007** La certificazione ha l'obiettivo di tutelare la sicurezza e la salute dei propri lavoratori e dell'ambiente lavorativo. Sambonet Paderno Industrie S.p.A. è la prima Azienda appartenente al settore metalmeccanico ad ottenere l'attestazione.

Sostenibilità, trasparenza e interazione con gli stakeholder sono le parole chiave della politica di Corporate Social Responsibility di Sambonet Paderno Industrie S.p.A..

I requisiti, l'impegno e il percorso intrapreso dall'azienda in questo ambito, l'ha portata nel 2016 - prima nel settore - a conseguire la certificazione SR10. Questo importante traguardo rappresenta una garanzia oggettiva in fatto di attenzione nell'interazione con gli stakeholder quali dipendenti, clienti, fornitori, comunità locali e associazioni sul territorio.

Questo ruolo socialmente responsabile ha recentemente spinto l'impresa ad aderire alla Rete Europea WHP (European Network for Health Promoting Workplace) affermandosi tra le pioniere del proprio territorio. Il progetto prevede che l'azienda non solo attui tutte le misure per prevenire infortuni e malattie sul luogo di lavoro ma - e soprattutto - che si impegni anche a offrire ai propri lavoratori opportunità per migliorare la propria salute, attraverso la promozione di uno stile di vita corretto in ambito alimentare, sportivo ed emotivo.



# Certifications

## UNI EN ISO 22000

Sambonet Paderno Industrie is the first company in its industry that has been awarded the EN UNI ISO 22000:2005 certification. This certification attests to the highest international standard both for the Group and for the whole food and beverage industry. The implementation of HACCP (Hazard Analysis and Critical Control Points, a hygiene system that prevents contamination hazards), ensures the provision of a safe and impeccable service to customers by meticulously and scrupulously assessing the hygienic and safety conditions of activities and products. This is a guarantee not only for HoReCa professionals, but also, and foremost, for final consumers.

## UNI EN ISO 9001:2015

This quality certification ensures compliance with the requirements of the international UNI EN ISO 9001:2008 standard, which guarantees the production and sale of products that fully meet customers' needs and expectations.

## NSF

Some products by Sambonet Paderno Industrie S.p.A. have obtained the prestigious NSF (National Sanitation Foundation) certification for compliance with the strict standards applied in the USA to materials in contact with foodstuffs. The NSF mark is a guarantee for manufacturers, inspectors and users.

## AEO

In 2008 Sambonet Paderno Industrie S.p.A. obtained the AEO Certification for Customs Simplifications and Security and Safety, valid for the EU. This programme provides a framework for governing customs regulations, guaranteeing that the company provides a reliable and secure service within the international supply chain. In addition, in 2011, Sambonet Paderno Industrie S.p.A. obtained the mutual recognition of the AEO programme with the Japanese customs administration, thus further improving customs relations with Japan.

## KNOWN CONSIGNOR

The "Known Consignor" approval issued by ENAC (Italian Civil Aviation Authority) certifies that the company is an originator of cargo suitable for carriage on any aircraft, in compliance with common safety procedures and provisions.

## ECCELLENZA 2006

This prestigious certificate of Excellence, awarded by Certiquality to Sambonet Paderno Industrie S.p.A. for the implementation of an integrated Quality, Environmental and Safety management system, has been granted only to few companies in Italy that have obtained the ISO 9001, ISO 14001 and BS OHSAS 18001 certifications.

## AWARD FOR EXCELLENCE

In 2006 Sambonet Paderno Industrie S.p.A. received the Award for Excellence for Innovation by Confindustria (the main organization representing Italian manufacturing and services companies) with reference to the framework for innovation of the EFQM—European Foundation for Quality Management.

## UNI EN ISO 22000

Prima nel suo settore Sambonet Paderno Industrie S.p.A. ha ottenuto la certificazione EN UNI ISO 22000:2005. Così come per l'intero comparto food and beverage, anche per il Gruppo la UNI EN ISO 22000:2005 rappresenta lo standard di più alto livello su scala internazionale. L'applicazione dei suoi requisiti, congiuntamente all'applicazione dell'HACCP (Hazard Analysis and Critical Control Points, sistema di autocontrollo igienico che previene i pericoli di contaminazione), garantisce alla clientela un servizio sicuro ed impeccabile attraverso una valutazione puntuale e scrupolosa delle condizioni igieniche e sanitarie delle attività e dei prodotti. Una garanzia di tutela non solo per il personale del canale professionale ma anche, e soprattutto, per il consumatore finale.

## UNI EN ISO 9001:2015

La certificazione di qualità conforme ai requisiti della normativa internazionale garantisce la produzione e la commercializzazione di prodotti che soddisfino pienamente i requisiti e le aspettative del cliente.

## NSF

La certificazione è stata conseguita per alcuni prodotti grazie al superamento delle rigorose norme applicate negli USA circa i materiali a contatto con gli alimenti. Il marchio NSF (National Sanitation Foundation) è sinonimo di garanzia per i costruttori, ispettori ed utilizzatori.

## AEO

La certificazione comunitaria AEO Semplificazioni doganali e Sicurezza, conseguita nel 2008, garantisce un'attività disciplinata della regolamentazione doganale dell'azienda qualificandola in fatto di affidabilità e sicurezza nella catena di approvvigionamento internazionale. Nel 2011, inoltre, Sambonet Paderno Industrie S.p.A. ha ottenuto il mutuo riconoscimento del programma AEO con l'amministrazione doganale giapponese, condizione che favorisce ulteriormente i rapporti con il paese.

## MITTENTE CONOSCIUTO

L'approvazione "Mittente Conosciuto" rilasciata da ENAC (Ente Nazionale Aviazione Civile) riconosce l'Azienda come sito d'origine di merce idonea al trasporto su aeromobili di qualsiasi tipo, in conformità alle procedure e disposizioni comuni di sicurezza.

## ECCELLENZA 2006

Certiquality ha attribuito a Sambonet Paderno Industrie S.p.A. il Certificato di Eccellenza per aver implementato un sistema di gestione integrata di Qualità, Ambiente e Sicurezza. L'ambito riconoscimento è ottenuto da poche aziende in Italia certificate ISO 9001, ISO 14001 e BS OHSAS 18001.

## AWARD FOR EXCELLENCE

Nel 2006 Sambonet Paderno Industrie S.p.A. è stata insignita dell'Award for Excellence per l'innovazione, rilasciato da Confindustria in riferimento al framework per l'innovazione dell'EFQM—European Foundation for Quality Management.



# ASEC LAB

ALIMENTARY  
SECURITY  
CONTROL  
LABORATORY



ASECLAB1@SAMBONET.IT



LABORATORIO DI ANALISI  
INTERNO CERTIFICATO



LAB N°1407

The items produced and sold by Sambonet Paderno Industrie S.p.A. not only comply with applicable regulations, but are also systematically tested. The Company can guarantee the suitability and safety of its products as it has established a specific workgroup and the ASEC Lab (Alimentary Security Control) internal laboratory, which analyses the materials intended to come into contact with foodstuffs. The laboratory is now accredited to carry out migration testing on steel, aluminum, porcelain, glass, entirely plastic materials and coloring in order to issue declarations of compliance, recognized by both national and international governments. The ASEC Lab is also accredited to determine pH levels, solvents and metals in water discharge, a guarantee for the internal analysis of the wastewater quality.

Oltre alla conformità rispetto alle norme vigenti, gli articoli prodotti e commercializzati da Sambonet Paderno Industrie S.p.A. sono controllati in maniera sistematica. Grazie alla costituzione di un gruppo di lavoro e del laboratorio interno ASEC Lab (Alimentary Security Control), specializzato nell'analisi di materiali destinati al contatto con gli alimenti, l'Azienda è in grado di garantire l'idoneità e la sicurezza dei propri prodotti. Il laboratorio è oggi accreditato per realizzare internamente test di migrazione su acciaio, alluminio, porcellana, vetro, materiali plastici e coloranti per il rilascio di dichiarazioni di conformità, riconosciute da qualsiasi ente nazionale e internazionale. ASEC Lab è inoltre accreditato per la determinazione di pH, solventi e metalli nelle acque scarico, una garanzia per le analisi interne sulla qualità delle proprie acque di scarico.





Pentolame  
Cookware, pots & pans  
Kochgeschirr  
Batteries de cuisine  
Baterías de cocina

## 10



GN food pans  
Contentori GN  
GN-Behälter  
Bacs GN  
Cubetas GN

## 51



Kitchen utensils  
Utensili da cucina  
Küchenzubehöre  
Ustensiles de cuisine  
Utensilios de cocina

## 78



Knives  
Coltelleria  
Kochmesser  
Coutellerie  
Cuchilleria

## 136



Pastry utensils  
Pasticceria  
Konditorei-Artikel  
La pâtisserie  
Pastelería

## 168



Ethnic cuisine  
Cucina etnica  
Ethnische Küche  
Cuisine ethnique  
Cocina étnica

## 249



Bar & Ice-Cream  
Bar e gelateria  
Bar u. Eis-Artikel  
Bar et glace  
Bar y heladería

## 275



Table top service  
Tavola  
Tischservice  
Service de table  
Servicio de mesa

## 339



Buffet display and presentation  
Buffet e presentazione  
Buffet und Präsentation  
Buffet et présentation  
Presentación de buffet

## 401



Chafing dishes / Trolleys  
Scaldavivande / Carrelli sala  
Chafing dishes / Servicewagen  
Chafing dishes / Chariots  
Chafing dishes / Carros

## 440



Storage, transport, cleaning  
Stoccaggio, trasporto, pulizia  
Lagerung, Transport, Reinigung  
Stockage, transport, nettoyage  
Almacenamiento, transporte, limpieza

## 465



Electric appliances  
Apparecchi elettrici  
Elektrogeräte  
Appareils électriques  
Aparatos eléctricos

## 495

























## ICONS - SIMBOLOGIA - SYMBOLE - SYMBOLES - ICONOS

<b>ABS</b>	Copolymer, acrylonitrile-butadiene-styrene Copolimero, acrilonitrile-butadiene-stirene	<b>PA+</b> <i>plus</i>	Polyamide (nylon 6.6) with fiberglass Poliammide (nylon 6.6) con fibra di vetro
<b>AG</b>	Silverplated Argentato	<b>PR</b>	Porcelain Porcellana
<b>AQ</b> PVD	Antique PVD	<b>PC</b>	Polycarbonate Policarbonato
<b>AR</b>	Natural slate Ardesia naturale	<b>PE</b>	Polyethylene Polietilene
<b>AY</b>	Acrylic Acrilico	<b>PMMA</b>	Polymethylmethacrylate, plexiglass Polimetilmetacrilato, plexiglas
<b>B</b>	Bamboo	<b>PPE</b>	Phenylene ether-expanded polypropylene Etere di polifenilene-polipropilene espanso
<b>BC</b>	Bone china	<b>PP</b>	Polypropylene Polipropilene
<b>BPA</b> FREE	Without bisphenol A Senza bisfenolo A	<b>PS</b>	Polystyrene Polistirene/polistirolo
<b>FE</b>	Metal Metallo	<b>PVD</b>	Physical vapor deposition Deposizione fisica da vapore
<b>HDPE</b>	High-density polyethylene Polietilene ad alta densità	<b>R</b>	Natural rattan Rattan naturale
<b>MF</b>	Melamine Melamina	<b>SAN</b>	Acrylonitrile-styrene copolymer Copolimero acrilonitrile-stirene
<b>MS</b>	Methylstyrene Metilstirene	<b>SMMA</b>	Styrene Methyl Methacrylate Stirene-metilmetacrilato
<b>NEW</b>	New Novità	<b>SS</b>	Stainless steel Acciaio inox
<b>NSF</b>	NSF certified Certificato NSF	<b>VG</b>	Vintage
<b>PA</b>	Polyamide (nylon) Poliammide (nylon)	<b>VG</b> PVD	Vintage PVD
		<b>W</b>	Wood Legno

# ICONS - SIMBOLOGIA - SYMBOLE - SYMBOLES - ICONOS

	Suitable for electric stoves Adatto per fornelli elettrici		GN size Misure GN
	Suitable for glass-ceramic stoves Adatto per fornelli in vitroceramica		Battery powered Alimentato a batterie
	Suitable for induction stoves Adatto per fornelli a induzione		Hand wash Lavare a mano
	Suitable for gas stoves Adatto per fornelli a gas		Do not use sharp objects Non usare oggetti taglienti
	For gluten free food Per alimenti senza glutine		Do not use on open flames Non utilizzare su fiamme libere
	Cooling Refrigerabile		Dishwasher safe Lavabile in lavastoviglie
	Heated Riscaldato		No dishwasher safe Non lavabile in lavastoviglie
	Water resistant Resistente all'acqua		Microwave safe Idoneo a microonde
	NO water resistant NON resistente all'acqua		Oven safe Idoneo a forno
	With light Con luce		No microwave safe Non idoneo a microonde
	Food safe Per alimenti		No oven safe Non idoneo a forno
	Stackable Impilabile		

Product list # Gluten Free - Spare parts  
Elenco prodotti Gluten Free - Ricambi  
Glutenfrei-Produktliste - Ersatzteile  
Liste produits Gluten Free - Pièces de rechange  
Lista productos Gluten Free - Repuestos

## 518



Index and sales terms  
Indice e condizioni di vendita  
Index und Verkaufsbedingungen  
Index et conditions de vente  
Índice y condiciones de venta

## 533







# SERIES 1100

STAINLESS STEEL COOKWARE  
PENTOLAME INOX



Outside and inside satin polished. Top edges mirror polished. Hollow tubular stay cool handles in stainless steel, ergonomically shaped. Extra thick edges. Double thick bottom. Sandwich thermoradiant bottom (stainless steel-aluminum-stainless steel). Concave bottom when cold and flat when hot (100% heat exploiting). Perfect for use on any type of stove, whether gas, electric, glass ceramic cooking surface or induction stove. All items have an induction suited sandwich bottom.

Finitura esterna ed interna satinata, bordo lucido. Manicatura tubolare in acciaio inox, anatomica, resistente al calore. Bordo rinforzato. Doppio spessore del fondo. Fondo termodiffusore sandwich (inox-alluminio-inox). Concavo a freddo e piano a caldo (sfruttamento del calore al 100%). Ideali per ogni tipo di cottura, gas, elettrica, vetroceramica e induzione. Tutti gli articoli sono dotati di speciale fondo termodiffusore adatto anche per piastre ad induzione.



**Stock pot**  
Pentola  
Hoher Suppentopf  
Marmite traiteur  
Olla recta

art.	Ø cm.	h.	lt.
11101-16	16	16	3,2
11101-20	20	20	6,2
11101-24	24	24	10,0
11101-28	28	28	16,5
11101-32	32	32	24,0
11101-36	36	36	36,0
11101-40	40	40	50,0
11101-45	45	45	70,0
11101-50	50	50	100,0



**Low stock pot**  
Pentola bassa  
Gemüsetopf  
Faitout  
Olla recta baja

art.	Ø cm.	h.	lt.
11105-16	16	14	2,7
11105-20	20	17	5,0
11105-24	24	21	8,5
11105-28	28	23	14,5
11105-32	32	26	22,0
11105-36	36	28	29,0
11105-40	40	32	40,0



**Saucepot**  
Casseruola alta  
Fleischtopf  
Brasière  
Cacerola alta

art.	Ø cm.	h.	lt.
11107-16	16	11,0	2,1
11107-20	20	13,0	4,0
11107-24	24	15,0	6,5
11107-28	28	17,5	10,8
11107-32	32	19,5	15,7
11107-36	36	21,5	22,0
11107-40	40	24,5	30,8
11107-45	45	27,5	44,0
11107-50	50	32,0	63,0



**Casserole pot**  
Casseruola bassa  
Bratentopf  
Sautoir  
Cacerola baja

art.	Ø cm.	h.	lt.
11109-16	16	7,5	1,3
11109-20	20	8,0	2,5
11109-24	24	9,5	4,3
11109-28	28	11,0	6,7
11109-32	32	12,5	10,0
11109-36	36	14,0	14,2
11109-40	40	15,5	19,5
11109-45	45	17,0	27,0
11109-50	50	19,0	37,0



**Colander for stock pot**  
Colapasta per pentola  
Seiher für Suppentopf  
Passoire pour marmite  
Colador para olla recta

art.	Ø cm.	h.
11123-20	20	22,0
11123-24	24	26,5
11123-28	28	29,5

**Suitable for both item 11105 and 11101.**  
Per art. 11105 e art. 11101.



**Stock pot with tap**  
Pentola con rubinetto  
Hochtopf mit Hahn  
Marmite avec robinet  
Olla con grifo

art.	Ø cm.	h.	lt.
11102-28	28	28	16,5
11102-32	32	32	24,0
11102-36	36	36	36,0
11102-40	40	40	50,0
11102-45	45	45	70,0
11102-50	50	50	100,0



**Steamer pot, perforated bottom**  
Inserto a vapore, fondo forato  
Dampf-Siebeinsatz  
Casserole à vapeur, perforée  
Cacerola base perforada

art.	Ø cm.	h.
11119-20	20	12,5
11119-24	24	15,0
11119-28	28	17,0
11119-32	32	19,0



**Saucepan**  
Casseruola alta  
Stielkasserolle, hoch  
Casserole haute  
Cazo recto alto

art.	Ø cm.	h.	lt.
11106-14	14	8,0	1,2
11106-16	16	11,0	2,1
11106-20	20	13,0	4,0
11106-24	24	15,0	6,5
11106-28*	28	17,5	10,8
11106-32*	32	19,5	15,7
11106-36*	36	21,5	22,0

\*With loop handle. – Con contromaniglia.



**Sauté pan**

Casseruola bassa  
Stielkasserolle, niedrig  
Plat à sauter  
Cazo recto bajo

art.	Ø cm.	h.	lt.
11108-16	16	6,5	1,3
11108-20	20	8,0	2,5
11108-24	24	9,5	4,3
11108-28*	28	11,0	6,7
11108-32*	32	12,5	10,0
11108-36*	36	14,0	14,2

\*With loop handle. – Con contromaniglia.



**Sauté pan**

Casseruola conica  
Sauteuse  
Sauteuse  
Cazo cónico

art.	Ø cm.	h.	lt.
11112-16	16	6,0	1,0
11112-18	18	6,0	1,2
11112-20	20	6,5	1,6
11112-24	24	7,5	2,7



**Curved sauté pan**

Casseruola "bombé"  
Sauteuse mit Schüttrand  
Sauteuse bombé  
Cazo bombeado

art.	Ø cm.	h.	lt.
11113-18	18	7,0	1,7
11113-20	20	7,5	2,2
11113-24	24	8,5	3,3
11113-26	26	9,0	4,2



**Frypan**

Padella  
Bratpfanne  
Poêle à frire  
Sartén

art.	Ø cm.	h.
11114-20	20	5,0
11114-24	24	5,0
11114-28	28	5,5
11114-32	32	6,0
11114-36*	36	6,0
11114-40*	40	6,0
11114-45*	45	6,5

\*With loop handle. – Con contromaniglia.



**Frypan, non stick coating**

Padella, antiaderente  
Bratpfanne mit Antihftbeschichtung  
Poêle avec revêtement anti-adhésif  
Sartén antiaderente

art.	Ø cm.	h.
11117-20	20	5,0
11117-24	24	5,0
11117-28	28	5,5
11117-32	32	6,0
11117-36	36	6,0
11117-40	40	6,0



**French omelet pan**

Tegame  
Servierpfanne  
Poêle à paella  
Paellera

art.	Ø cm.	h.
11115-20	20	5,0
11115-24	24	5,0
11115-28	28	5,5
11115-32	32	6,0
11115-36	36	6,0
11115-40	40	6,0
11115-45	45	6,5
11115-50	50	8,0



**Cover, reinforced edge**

Coperchio, bordo rinforzato  
Deckel mit Randverstärkung  
Couvercle, bord renforcé  
Tapa, borde reforzado

art.	Ø cm.
11161-12	12
11161-14	14
11161-16	16
11161-18	18
11161-20	20
11161-22	22
11161-24	24
11161-28	28
11161-32	32
11161-36	36
11161-40	40
11161-45	45
11161-50	50
11161-60	60







# SERIES 2100

STAINLESS STEEL COOKWARE  
PENTOLAME INOX



The serie 2100 has the same characteristics of the serie 1100. It varies only for the shape of the handles of 2 handles items. Perfect for use on any type of stove, whether gas, electric, glass ceramic cooking surface or induction stove. All items have an induction suited sandwich bottom.

La serie 2100 ha le stesse caratteristiche della serie 1100. Differisce solo per una diversa manicatura sugli articoli a 2 maniglie. Ideali per ogni tipo di cottura, gas, elettrica, vetroceramica e induzione. Tutti gli articoli sono dotati di speciale fondo termodiffusore adatto anche per piastre ad induzione.



**Stock pot**  
Pentola  
Hoher Suppentopf  
Marmite traiteur  
Olla recta

art.	Ø cm.	h.	lt.
12101-16	16	16	3,2
12101-20	20	20	6,2
12101-24	24	24	10,0
12101-28	28	28	16,5
12101-32	32	32	24,0
12101-36	36	36	36,0
12101-40	40	40	50,0
12101-45	45	45	70,0
12101-50	50	50	100,0



**Saucepot**  
Casseruola alta  
Fleischtopf  
Brasière  
Cacerola alta

art.	Ø cm.	h.	lt.
12107-16	16	11,0	2,1
12107-20	20	13,0	4,0
12107-24	24	15,0	6,5
12107-28	28	17,5	10,8
12107-32	32	19,5	15,7
12107-36	36	21,5	22,0
12107-40	40	24,5	30,8
12107-45	45	27,5	44,0
12107-50	50	32,0	63,0



**Casserole pot**  
Casseruola bassa  
Bratentopf  
Sautoir  
Cacerola baja

art.	Ø cm.	h.	lt.
12109-16	16	7,5	1,3
12109-20	20	8,0	2,5
12109-24	24	9,5	4,3
12109-28	28	11,0	6,7
12109-32	32	12,5	10,0
12109-36	36	14,0	14,2
12109-40	40	15,5	19,5
12109-45	45	17,0	27,0
12109-50	50	19,0	37,0



# SERIES 1000

STAINLESS STEEL COOKWARE  
PENTOLAME INOX



Outside and inside satin polished. Non-drip edge. Hollow tubular stay cool handles in stainless steel, ergonomically shaped. Uniform thickness in sides and bottoms. Sandwich thermoradiant bottom (stainless steel-aluminum-stainless steel). Concave bottom when cold and flat when hot (100% heat exploiting). Perfect for use on any type of stove, whether gas, electric, glass ceramic cooking surface or induction stove. All items have an induction suited sandwich bottom.

Finitura esterna ed interna satinata. Bordo a versare. Manicatura tubolare in acciaio inox, anatomica, resistente al calore. Parete e fondo a spessore uniforme. Fondo termodiffusore sandwich (inox-alluminio-inox). Concavo a freddo e piano a caldo (sfruttamento del calore al 100%). Ideali per ogni tipo di cottura, gas, elettrica, vetroceramica e induzione. Tutti gli articoli sono dotati di speciale fondo termodiffusore adatto anche per piastre ad induzione.



**Stock pot**

Pentola  
Hoher Suppentopf  
Marmite traiteur  
Olla recta

art.	Ø cm.	h.	lt.
11001-16	16	16,0	3,2
11001-18	18	16,0	4,0
11001-20	20	18,0	5,5
11001-22	22	22,0	8,3
11001-24	24	24,0	10,5
11001-28	28	28,0	17,0
11001-32	32	27,5	20,4
11001-36	36	36,0	36,5
11001-40	40	40,0	50,0
11001-45	45	40,0	63,5
11001-50	50	50,0	98,0
11001-60	60	55,0	150,0



**Saucepot**

Casseruola alta  
Fleischtopf  
Brasière  
Cacerola alta

art.	Ø cm.	h.	lt.
11007-16	16	9,5	1,9
11007-18	18	10,8	2,7
11007-20	20	12,0	3,8
11007-22	22	13,0	5,0
11007-24	24	14,5	6,5
11007-28	28	16,0	9,8
11007-32	32	19,5	15,4
11007-36	36	21,5	20,5
11007-40	40	24,0	30,1
11007-45	45	27,0	42,9
11007-50	50	30,0	58,0
11007-60	60	35,0	99,0



**Casserole pot**

Casseruola bassa  
Bratentopf  
Sautoir  
Cacerola baja

art.	Ø cm.	h.	lt.
11009-16	16	6,5	1,3
11009-18	18	7,0	1,8
11009-20	20	7,5	2,5
11009-24	24	8,0	3,7
11009-28	28	9,5	5,8
11009-32	32	11,0	9,2
11009-36	36	13,0	13,0
11009-40	40	14,5	18,0
11009-45	45	15,5	24,6
11009-50	50	19,0	37,0
11009-60	60	25,0	70,7



**Saucepan**

Casseruola mezza alta  
Bratentopf, mittelhoch  
Casserole  
Cacerola francés

art.	Ø cm.	h.	lt.
11010-16	16	8	1,6
11010-18	18	9	2,3
11010-20	20	10	3,1
11010-24	24	12	5,4



**Sauté pan**

Casseruola conica  
Sauteuse  
Sauteuse  
Cazo cónico

art.	Ø cm.	h.	lt.
11012-16	16	6,0	1,0
11012-18	18	6,0	1,2
11012-20	20	6,5	1,6
11012-24	24	7,5	2,7



**Curved sauté pan**

Casseruola bombé  
Sauteuse mit Schüttrand  
Sauteuse bombé  
Cazo bombeado

art.	Ø cm.	h.	lt.
11013-18	18	7,0	1,7
11013-20	20	7,5	2,2
11013-24	24	8,5	3,3
11013-26	26	9,0	4,2







**Saucepan**

Casseruola alta  
Stielkasserolle, hoch  
Casserole haute  
Cazo recto alto

art.	Ø cm.	h.	lt.
11006-12	12	7,0	0,8
11006-14	14	8,0	1,2
11006-16	16	9,5	1,9
11006-18	18	10,8	2,7
11006-20	20	12,0	3,8
11006-22	22	13,0	5,0
11006-24	24	14,5	6,5
11006-28*	28	16,0	9,8
11006-32*	32	19,5	15,4
11006-36*	36	21,5	20,5

\*With loop handle. – Con contromaniglia.



**Saucepan**

Casseruola mezza alta  
Stielkasserolle, mittelhoch  
Casserole  
Cazo recto francés

art.	Ø cm.	h.	lt.
11011-16	16	8	1,6
11011-18	18	9	2,3
11011-20	20	10	3,1
11011-24	24	12	5,4



**Sauté pan**

Casseruola bassa  
Stielkasserolle, niedrig  
Plat à sauter  
Cazo recto bajo

art.	Ø cm.	h.	lt.
11008-16	16	6,5	1,3
11008-18	18	7,0	1,8
11008-20	20	7,5	2,5
11008-24	24	8,0	3,7
11008-28*	28	9,5	5,8
11008-32*	32	11,0	9,2
11008-36*	36	13,0	13,0

\*With loop handle. – Con contromaniglia.



**Frypan**

Padella  
Bratpfanne  
Poêle à frire  
Sartén

art.	Ø cm.	h.
11014-20	20	5,0
11014-24	24	5,0
11014-28	28	5,5
11014-32	32	6,0
11014-36*	36	6,0
11014-40*	40	6,0
11114-45*	45	6,5

\*With loop handle. – Con contromaniglia.



**Frypan, non stick**

Padella, antiaderente  
Bratpfanne, nichttaftend  
Poêle, anti-adhérente  
Sartén antiadherente

art.	Ø cm.	h.
11117-20	20	5,0
11117-24	24	5,0
11117-28	28	5,5
11117-32	32	6,0
11117-36	36	6,0
11117-40	40	6,0



**French omelet pan**

Tegame  
Servierpfanne  
Poêle à paella  
Paellera

art.	Ø cm.	h.
11115-20	20	5,0
11115-24	24	5,0
11115-28	28	5,5
11115-32	32	6,0
11115-36	36	6,0
11115-40	40	6,0
11115-45	45	6,5
11115-50	50	8,0



**Cover**

Coperchio  
Deckel  
Couvercle  
Tapa

art.	Ø cm.
11061-12	12
11061-16	16
11061-18	18
11061-20	20
11061-22	22
11061-24	24
11061-28	28
11061-32	32
11061-36	36
11061-40	40
11061-45	45
11061-50	50
11161-60	60





# SERIES 2000

STAINLESS STEEL COOKWARE  
PENTOLAME INOX



The serie 2000 has the same characteristics of the serie 1000. It varies only for the shape of the handles of 2 handles items. Perfect for use on any type of stove, whether gas, electric, glass ceramic cooking surface or induction stove. All items have an induction suited sandwich bottom.

La serie 2000 ha le stesse caratteristiche della serie 1000. Differisce solo per una diversa manicatura sugli articoli a 2 maniglie. Ideali per ogni tipo di cottura, gas, elettrica, vetroceramica e induzione. Tutti gli articoli sono dotati di speciale fondo termodiffusore adatto anche per piastre ad induzione.



**Stock pot**

Pentola  
Hoher Suppentopf  
Marmite traiteur  
Olla recta

art.	Ø cm.	h.	lt.
12001-16	16	16,0	3,2
12001-18	18	16,0	4,0
12001-20	20	18,0	5,5
12001-22	22	22,0	8,3
12001-24	24	24,0	10,5
12001-28	28	28,0	17,0
12001-32	32	27,5	20,4
12001-36	36	36,0	36,5
12001-40	40	40,0	50,0
12001-45	45	40,0	63,5
12001-50	50	50,0	98,0
12001-60	60	55,0	150,0



**Saucepot**

Casseruola alta  
Fleischtopf  
Brasière  
Cacerola alta

art.	Ø cm.	h.	lt.
12007-16	16	9,5	1,9
12007-18	18	10,8	2,7
12007-20	20	12,0	3,8
12007-22	22	13,0	5,0
12007-24	24	14,5	6,5
12007-28	28	16,0	9,8
12007-32	32	19,5	15,4
12007-36	36	21,5	20,5
12007-40	40	24,0	30,1
12007-45	45	27,0	42,9
12007-50	50	30,0	58,0
12007-60	60	35,0	99,0



**Casserole pot**

Casseruola bassa  
Bratentopf  
Sautoir  
Cacerola baja

art.	Ø cm.	h.	lt.
12009-16	16	6,5	1,3
12009-18	18	7,0	1,8
12009-20	20	7,5	2,5
12009-24	24	8,0	3,7
12009-28	28	9,5	5,8
12009-32	32	11,0	9,2
12009-36	36	13,0	13,0
12009-40	40	14,5	18,0
12009-45	45	15,5	24,6
12009-50	50	19,0	37,0
12009-60	60	25,0	70,7



**Sauté pan**

Casseruola conica  
Sauteuse  
Sauteuse  
Cazo cónico

art.	Ø cm.	h.	lt.
11012-16	16	6,0	1,0
11012-18	18	6,0	1,2
11012-20	20	6,5	1,6
11012-24	24	7,5	2,7



**Curved sauté pan**

Casseruola bombé  
Sauteuse mit Schütterand  
Sauteuse bombé  
Cazo bombeado

art.	Ø cm.	h.	lt.
11013-18	18	7,0	1,7
11013-20	20	7,5	2,2
11013-24	24	8,5	3,3
11013-26	26	9,0	4,2



**Saucepan**

Casseruola mezza alta  
Stielkasserolle, mittelhoch  
Casserole  
Cazo recto francés

art.	Ø cm.	h.	lt.
11011-16	16	8,0	1,6
11011-18	18	9,0	2,3
11011-20	20	10,0	3,1
11011-24	24	12,0	5,4



**Steamer pot, perforated bottom**

Inserto a vapore, fondo forato  
Dampf-Siebeinsatz  
Casserole à vapeur, perforée  
Cacerola base perforada

art.	Ø cm.	h.
12119-20	20	12,5
12119-24	24	15,0
12119-28	28	17,0
12119-32	32	19,0



**Asparagus-pot with lid**

Pentola cuociasparagi con coperchio  
Spargeltopf mit Deckel  
Cuit-asperges avec couvercle  
Olla espárragos con tapa

art.	Ø cm.	h.	lt.
12037-16	16	24,0	4,8





**Saucepan**

Casseruola alta  
Stielkasserolle, hoch  
Casserole haute  
Cazo recto alto

art.	Ø cm.	h.	lt.
11006-12	12	7,0	0,8
11006-14	14	8,0	1,2
11006-16	16	9,5	1,9
11006-18	18	10,8	2,7
11006-20	20	12,0	3,8
11006-22	22	13,0	5,0
11006-24	24	14,5	6,5
11006-28*	28	16,0	9,8
11006-32*	32	19,5	15,4
11006-36*	36	21,5	20,5

\*With loop handle. – Con contromaniglia.



**Sauté pan**

Casseruola bassa  
Stielkasserolle, niedrig  
Plat à sauter  
Cazo recto bajo

art.	Ø cm.	h.	lt.
11008-16	16	6,5	1,3
11008-18	18	7,0	1,8
11008-20	20	7,5	2,5
11008-24	24	8,0	3,7
11008-28*	28	9,5	5,8
11008-32*	32	11,0	9,2
11008-36*	36	13,0	13,0

\*With loop handle. – Con contromaniglia.



**Frypan**

Padella  
Bratpfanne  
Poêle à frire  
Sartén

art.	Ø cm.	h.
11014-20	20	5,0
11014-24	24	5,0
11014-28	28	5,5
11014-32	32	6,0
11014-36*	36	6,0
11014-40*	40	6,0
11114-45*	45	6,5

\*With loop handle. – Con contromaniglia.



**Frypan, non stick**

Padella, antiaderente  
Bratpfanne, nichttaftend  
Poêle, anti-adhérente  
Sartén antiadherente

art.	Ø cm.	h.
11117-20	20	5,0
11117-24	24	5,0
11117-28	28	5,5
11117-32	32	6,0
11117-36	36	6,0
11117-40	40	6,0



**French omelet pan**

Tegame  
Servierpfanne  
Poêle à paella  
Paellera

art.	Ø cm.	h.
11115-20	20	5,0
11115-24	24	5,0
11115-28	28	5,5
11115-32	32	6,0
11115-36	36	6,0
11115-40	40	6,0
11115-45	45	6,5
11115-50	50	8,0



**Cover**

Coperchio  
Deckel  
Couvercle  
Tapa

art.	Ø cm.
11061-16	16
11061-18	18
11061-20	20
11061-22	22
11061-24	24
11061-28	28
11061-32	32
11061-36	36
11061-40	40
11061-45	45
11061-50	50
11161-60	60



# FOR GLUTEN-FREE COOKING



AL SERVIZIO DELLA CUCINA SENZA GLUTINE

FOR PRODUCT # LIST SEE PAGES FROM 518 TO 523  
PER L'ELENCO PRODOTTI VEDI PAGINE DA 518 A 523



Consistently with the functional approach, which has always marked the brand, Paderno offers a complete product line and professional tools, easily recognizable in the kitchen, which can reduce possible mistakes during their use to protect people affected by celiac disease. Developed and realized in 2013 in collaboration with Associazione Italiana Celiachia Lombardia ONLUS (Italian Society for the Celiac Disease – Lombardy Section), this project makes Sambonet Paderno Industrie S.p.A. the first company in its market that offers to the HoReCa channel a complete line of items intended for gluten-free cooking.

Some distinguished special features, such as golden PVD handles for pans and pots and a special customised logo for utensils, will allow professionals to easily identify all these items in the kitchen.

This product line aims at:

- Reducing the risk of accidental food cross-contamination;
- Making it easier for professionals to work and provide services to clients with food intolerances;
- Raising awareness on the gluten-free diet issue in the industry so as to respond to the new needs of consumers.

Coerentemente all'ottica di servizio che contraddistingue da sempre il marchio, Paderno propone una linea completa di articoli e strumenti professionali facilmente identificabili in cucina, in grado di abbattere eventuali errori durante il loro utilizzo a salvaguardia del cliente celiaco e di tutti gli intolleranti. Sviluppato e concretizzato nel 2013 in collaborazione con l'Associazione Italiana Celiachia Lombardia ONLUS, questo progetto colloca Sambonet Paderno Industrie come prima azienda del settore a offrire al canale Ho.Re.Ca una linea completa di articoli da destinare alla preparazione di pietanze senza glutine.

Attraverso alcuni elementi distintivi e differenzianti, come manici in PVD oro per pentole e padelle e personalizzazione con un logo specifico per utensili, tutti gli strumenti saranno facilmente identificabili in cucina.

Questa gamma contribuisce a:

- Diminuire il rischio di accidentali contaminazioni crociate degli alimenti;
- Facilitare il professionista nell'operare e nell'offrire un servizio a favore del cliente con intolleranze alimentari;
- Sensibilizzare il settore sul tema "gluten free" di fronte alle nuove esigenze dei consumatori.



**Stock pot**  
Pentola alta  
Hoher Suppentopf  
Marmite traiteur  
Olla recta

art.	Ø cm.	h. cm.	lt.
12001F20	20	18,0	5,5
12001F24	24	24,0	10,5
12001F28	28	28,0	17,0



**Colander for stock pot**  
Colapasta per pentola  
Seiher für Suppentopf  
Passoire pour marmite  
Colador para olla recta

art.	Ø cm.	h. cm.
12123F20	20	22,0
12123F24	24	26,5
12123F28	28	29,5



**Saucepot 2 handles**  
Casseruola alta 2 maniglie  
Fleischtopf  
Brosière  
Cacerola alta

art.	Ø cm.	h. cm.	lt.
12007F16	16	9,5	1,9
12007F24	24	14,5	6,5
12007F28	28	16,0	9,8



**Frypan**  
Padella  
Bratpfanne  
Poêle à frire  
Sartén

art.	Ø cm.	h. cm.
11014F20	20	5,0
11014F24	24	5,0
11014F28	28	5,5
11014F32	32	6,0



**Cover**  
Coperchio  
Deckel  
Couvercle  
Tapa

art.	Ø cm.
11161F16	16
11161F20	20
11161F24	24
11161F28	28



**Strainer with hook**  
Colapasta con manico e gancio  
Stielsieb mit Haken  
Passoire avec poignée et crochet  
Colador con asa y gancho

art.	Ø cm.	h. cm.	lt.
11924F20	20	12	3,6



**Conical colander**  
Colapasta tronco conico  
Konisches Gemüsesieher  
Passoire à légumes conique  
Colador cónico

art.	Ø cm.	h. cm.	lt.
11930F24	24	12	3,5



**Labels 14 allergens**  
Etichette 14 allergeni  
Etiketten 14 Allergene  
Etiquettes 14 allergènes  
Etiquetas 14 alergenos

art.	dim. cm.	Pcs/Pz
44630-02	7,5x4	500



**Labels Allergens**  
Etichette allergeni  
Etiketten Allergene  
Etiquettes allergènes  
Etiquetas alérgenos

art.	dim. cm.	Pcs/Pz
44630-06	7x4,5	500





**Delivery labels with allergens**  
Etichette delivery con allergeni  
Lieferetiketten mit Allergenen  
Etiquettes livraison avec allergènes  
Etiquetas entrega con alérgenos

art.	dim. cm.	Pcs/Pz
44630-07	14x4,5	250



**Cutting board**  
Tagliere  
Tranchierbrett  
Planche à découper  
Tabla de corte

art.	GN	dim. cm.	col.
42538-00	1/1	53x32,5x2	○
42538-01	1/1	53x32,5x2	●
42538-02	1/1	53x32,5x2	●
42538-03	1/1	53x32,5x2	●
42538-04	1/1	53x32,5x2	●
42538-05	1/1	53x32,5x2	●
42538-09	1/1	53x32,5x2	●



**Cutting board**  
Tagliere  
Tranchierbrett  
Planche à découper  
Tabla de corte

art.	GN	dim. cm.	col.
42522-07	-	32x26,5x2	●
42538-07	1/1	53x32,5x2	●
42539-07	-	60x40x2	●

**See also pages 164-165.**  
Vedi anche pagg 164-165.



**GN-containers**  
GN bacinelle  
GN-Behälter  
GN bacs  
GN cubetas

art.	des	dim. cm.	lt.
15101-10	1/1	53x32,5x10	13,3
15105-10	1/2	32,5x26,5x10	6,1
15107-10	1/3	32,5x17,5x10	3,8
15108-10	1/4	26,4x16,2x10	2,6
15109-10	1/6	17,6x16,2x10	1,6
15110-10	1/9	17,6x10,8x10	0,9

**See also pages 68-71. – Vedi anche pagg 68-71.**



**GN-lids**  
GN coperchi  
GN-Deckel  
GN couvercles  
GN tapas

art.	des	dim. cm.
14922-77	1/1	53x3,25
14925-77	1/2	32,5x26,5
14927-77	1/3	32,5x17,5
14928-77	1/4	26,4x16,2
14929-77	1/6	17,6x16,2
14930-77	1/9	17,6x10,8



**Digital thermometer**  
Termometro digitale  
Elektronisches Thermometer  
Thermomètre digital  
Termómetro digital

art.	range	res.
49880-17	-49,9>299,9°C	0,1/1°C

**IP66/67. Dim. 19x50x157 mm.**  
**See also page 130. – Vedi anche pag 130.**

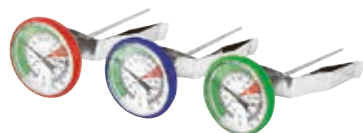

**Milk frothing thermometers, 3 pcs**  
Termometri latte/barista, 3 pz  
Mich-Thermometer, 3 Stk  
Thermomètres à lait, 3 pièces  
Termómetros leche, 3 pz

art.	Ø cm.	range	res.
49709-03	4,5	-10+110°C	1°C

**Red, green and blue, to easily identify different types of milk used, to avoid cross-contamination. Stem 175 mm. – Rosso, verde e blu, per identificare facilmente i diversi tipi di latte utilizzati, per evitare la contaminazione incrociata. Stelo 175 mm.**



**Adjustable brush, pizza peels**  
Spazzola orientabile, pale pizza  
Drehbare Bürste, Pizzaschaufeln  
Brosse orientable, pelles à pizza  
Cepillo orientable, palas pizza

art.	des	Ø cm.	dim. cm.	l. cm.
41767G20	Brush/Spazzola	-	20x6	160
41704G33	Peel/Pala	-	33x33	150
41704G36	Peel/Pala	-	36x36	150
41737G20	Small peel/Palettino	20	-	150
41737G23	Small peel/Palettino	23	-	150

**See also page 266. – Vedi anche pag 266.**



# SERIES 2500 3-PLY

STAINLESS STEEL COOKWARE  
PENTOLAME INOX



Paderno serie 2500 3-ply is especially designed for professional kitchens, features super heat-conductive multi-layer construction that distributes heat from bottom to rim quickly and evenly. Outside and inside satin polished. Non-drip edge. Stainless steel handles, ergonomically shaped. Uniform thickness in sides and bottoms. Energy saving on all types of cookers. Suitable for all cooking ranges, induction hobs included. induzione.

La serie Paderno 2500 3-ply concepita per l'utilizzo nelle cucine professionali è costruita in materiale multistrato che assicura una distribuzione rapida ed uniforme del calore su tutta la superficie dell'utensile. Finitura esterna ed interna satinata. Bordo a versare. Manicatura anatomica in acciaio inox. Parete e fondo a spessore uniforme. Risparmio di energia su tutti i piani di cottura. Ideali per ogni tipo di cottura inclusa l'induzione.



**Saucepot**

Casseruola alta  
Fleischtopf  
Brasière  
Cacerola alta

art.	Ø cm.	h.	lt.
12507-24	24	11,5	5,0
12507-28	28	14,0	8,5



**Casserole pot**

Casseruola bassa  
Bratentopf  
Sautoir  
Cacerola baja

art.	Ø cm.	h.	lt.
12509-20	20	9,5	2,8
12509-24	24	10,5	4,7
12509-28	28	11,0	6,5



**Saucepan**

Casseruola mezza alta  
Stielkasserolle, mittelhoch  
Casserole  
Cazo recto francés

art.	Ø cm.	h.	lt.
12511-16	16	7,5	1,5
12511-18	18	8,0	2,0
12511-20	20	8,8	2,5
12511-24	24	10,5	4,6



**Sauté pan**

Casseruola bassa  
Stielkasserolle, niedrig  
Plat à sauter  
Cazo recto bajo

art.	Ø cm.	h.	lt.
12508-24	24	5,0	2,0



**Wok with grid and cover**

Wok c/griglia e coperchio  
Wok mit Rost und Deckel  
Wok avec grille et couvercle  
Wok con rejilla y tapa

art.	Ø cm.	h.
12529-32	32	8



**Curved sauté pan**

Casseruola bombé  
Sauteuse mit Schüttrand  
Sauteuse bombé  
Cazo bombeado

art.	Ø cm.	h.	lt.
12513-16	16	6,0	1,2
12513-18	18	6,5	1,6
12513-20	20	7,0	2,0
12513-24	24	8,5	3,8



**Frypan**

Padella  
Bratpfanne  
Poêle à frire  
Sartén

art.	Ø cm.	h.
12514-24	24	5,5
12514-26	26	5,5
12514-28	28	5,5
12514-32	32	4,0
12514-36	36	4,0



**Frypan, non stick coating**

Padella, antiaderente  
Bratpfanne mit Antihaftbeschichtung  
Poêle avec revêtement anti-adhésif  
Sartén antiadherente

art.	Ø cm.	h.
12517-24	24	5,5
12517-26	26	5,5
12517-28	28	5,5
12517-32	32	5,5
12517-36	36	5,5





**Frypan**

Padella  
Bratpfanne  
Poêle à frire  
Sartén

art.	Ø cm.	h.
12514-20	20	3,0

**Mirror finishing.** – Finitura lucida.



**Saucepot with lid**

Casseruola alta, con coperchio  
Fleischtopf mit Deckel  
Brasière avec couvercle  
Cacerola alta con tapa

art.	Ø cm.	h.	lt.
12509-12	12	6	0,7

**Mirror finishing.** – Finitura lucida.



**Sauté pan with double spouts**

Casseruola bassa con doppio becco  
Stielkasserolle, niedrig, 2 Schnabel  
Plat à sauter, 2 becs  
Cazo recto bajo, 2 picos

art.	Ø cm.	h.	lt.
12511-10	10	5	0,4

**Mirror finishing.** – Finitura lucida.



**Sauté pan**

Casseruola bassa  
Stielkasserolle, niedrig  
Plat à sauter  
Cazo recto bajo

art.	Ø cm.	h.	lt.
12511-12	12	6	0,7
12511-14	14	7	1,0

**Mirror finishing.** – Finitura lucida.



**Cover**

Coperchio  
Deckel  
Couvercle  
Tapa

art.	Ø cm.
12561-12	12
12561-16	16
12561-18	18
12561-20	20
12561-24	24
12561-26	26
12561-28	28



**Cover**

Coperchio  
Deckel  
Couvercle  
Tapa

art.	Ø cm.
11061-12	12
11061-16	16
11061-18	18
11061-20	20
11061-24	24
11061-28	28





# MISCELLANEOUS COMPLEMENTI

STAINLESS STEEL COOKWARE  
PENTOLAME INOX

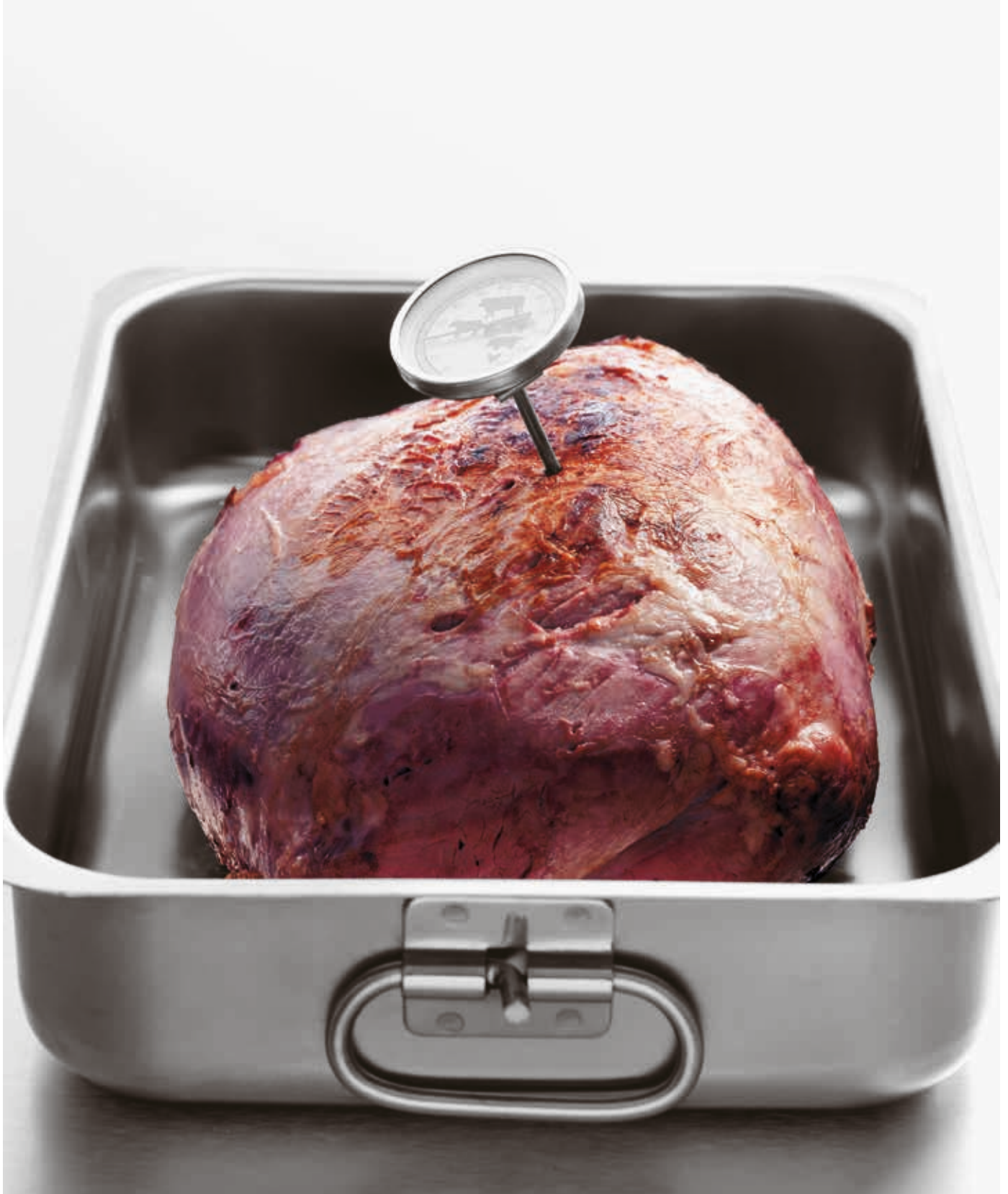



**Roasting pan**

Tegame  
Bräter  
Plaque à rôtir  
Rustidera

art.	cm.	h.
11941-35	35x25	8
11941-40	40x26	9
11941-45	45x30	9
11941-50	50x30	9
11941-60	60x35	9



**Heavy roasting pan**

Tegame pesante  
Bräter, Schwerausführung  
Plaque à rôtir lourde  
Rustidera pesada

art.	cm.	h.
11943-40	40x26	9
11943-45	45x30	9
11943-50	50x30	9
11943-60	60x35	9
11943-61*	61x43	9

\*For 2/1 GN ovens. – Per forno GN 2/1.



**Heavy roasting pan**

Tegame pesante  
Bräter, Schwerausführung  
Plaque à rôtir lourde  
Rustidera pesada

art.	cm.	h.
11944-40	40x26	9
11944-45	45x30	9
11944-50	50x30	9
11944-60	60x35	9
11944-61*	61x43	9

\*For 2/1 GN ovens. – Per forno GN 2/1.



**Lid**

Coperchio  
Deckel  
Couvercle  
Tapa

art.	cm.
11948-40	40x26
11948-45	45x30
11948-50	50x30
11948-60	60x35
11948-61*	61x43

\*For 2/1 GN ovens. – Per forno GN 2/1.



**Roasting pan with cover**

Brasiera con coperchio  
Brasiere mit Deckel  
Braisière avec couvercle  
Rustidera alta con tapa

art.	cm.	h.
11965-50	50x30	15
11965-60	60x35	15
11965-61*	61x43	15

\*For 2/1 GN ovens. – Per forno GN 2/1.



**Fry dripping tray, stainless steel**

Colafritto, inox  
Pommes-Frites-Seiher, Edelstahl Rostfrei  
Egouttoir à friture, inox  
Escurridor para fritura, inox

art.	Ø cm.	h.
41930-39	41	14

**Detachable drip tray.**

Vassoio raccogli liquidi removibile.



INDUCTION  
READY!

**Fish kettle**

Pesciera  
Fischkochkessel  
Poissonnière  
Hervidor pescado

art.	cm.	h.
41964-45	46x15,5	10,5
41964-60	61,5x18,5	11,0

**Equipped with grid and cover.**

Fornita con griglia e coperchio.



**Whistling kettle**

Bollitore  
Kocher  
Bouilloire à sifflet  
Pava

art.	Ø cm.	h.	lt.
41914-03	20	18	2,8





**Canister**

Contentitore cilindrico  
Behälter  
Bahut  
Contenedor cilíndrico

art.	Ø cm.	h.	lt.
11913-16	16	12	2,4
11913-20	20	16	5,0
11913-24	24	20	9,0
11913-28	28	24	14,5



**Bain-marie pot**

Casseruola bagnomaria  
Wasserbadkasserolle  
Casserole bain-marie  
Baño maria

art.	Ø cm.	h.	lt.
11910-12	12	14	1,4
11910-14	14	16	2,5
11910-16	16	18	3,6
11910-18	18	20	5,0
11910-20	20	22	7,0



**Bain-marie pot**

Bagnomaria  
Behälter  
Casserole bain-marie  
Baño maria

art.	Ø cm.	h.	lt.
11911-12	12	14	1,4
11911-14	14	16	2,5
11911-16	16	18	3,6
11911-18	18	20	5,0
11911-20	20	22	7,0



**Bain-marie, stackable**

Bagno-maria impilabili  
Bain-Marie, stapelbar  
Bain-marie, empilables  
Baño maria, apilable

art.	cm.	h.	lt.
44501-01	24x24	23,5	13,0
44501-02	24x24	16,0	9,0
44501-03	24x24	7,5	4,0



**Bain-marie, stackable**

Bagno-maria impilabili  
Bain-Marie, stapelbar  
Bain-marie, empilables  
Baño maria, apilable

art.	cm.	h.	lt.
44502-01	15,5x15,5	23,5	5,0
44502-02	15,5x15,5	16,0	3,5
44502-03	15,5x15,5	7,5	1,5



**Bain-marie, stackable**

Bagno-maria impilabili  
Bain-Marie, stapelbar  
Bain-marie, empilables  
Baño maria, apilable

art.	cm.	h.	lt.
44503-01	15,5x10,5	16,0	2,5
44503-02	15,5x10,5	7,5	1,0
44503-03	15,5x10,5	5,5	0,5



**Bain-marie lid**

Coperchio bagnomaria  
Wasserbadkasserolle-Deckel  
Couverte pour bain-marie  
Tapa para baño maria

art.	cm.
44501-04	24x24
44502-04	15,5x15,5
44503-04	15,5x10,5



**1/4-Segment colander**

Colapasta 1/4  
1/4 Seiher-Einsatz  
Passoire cuit-pâtes, 1/4  
Colador 1/4

art.	Ø cm.	h.	lt.
11922-36	36	23	5,5
11922-40	40	26	7,5

**For items/Per art.:**  
**11007-11107-12007-12107-16929.**



**1/4-Segment wire colander**

Colapasta 1/4 a rete  
1/4 Netzseiher-Einsatz  
Passoire cuit-pâtes à gaze, 1/4  
Colador red 1/4

art.	Ø cm.	h.
12992-36	36	23
12992-40	40	26

**For items/Per art.:**  
**11007-11107-12007-12107-16929.**



# SERIES 6100

ALUMINUM COOKWARE  
PENTOLAME ALLUMINIO



Made in heavy duty aluminum.  
Hollow tubular handles in stainless steel 18/10, stay cool.  
Rounded corners provide easy cleanup.  
Thickness from mm 2 to mm 5,5.

Esecuzione in alluminio pesante.  
Manicatura tubolare in acciaio inossidabile 18/10, resistente al calore.  
Ampio raggio di raccordo fondo-parete, igienico e facile da pulire.  
Spessore da mm 2 a mm 5,5.



**Stock pot**

Pentola  
Hoher Suppentopf  
Marmite traiteur  
Olla recta

art.	Ø cm.	h.	lt.
16101-16	16	16,0	3,2
16101-20	20	20,0	6,2
16101-24	24	24,0	10,0
16101-28	28	28,0	16,5
16101-32	32	29,5	22,0
16101-36	36	36,0	36,0
16101-40	40	40,0	50,0
16101-45	45	45,0	70,0
16101-50	50	50,0	100,0



**Saucepot**

Casseruola alta  
Fleischtopf  
Brasière  
Cacerola alta

art.	Ø cm.	h.	lt.
16107-16	16	11,0	2,1
16107-20	20	13,0	4,0
16107-24	24	15,0	6,5
16107-28	28	17,5	10,8
16107-32	32	19,5	15,7
16107-36	36	21,0	21,5
16107-40	40	24,0	30,0
16107-45	45	27,0	43,0
16107-50	50	30,0	59,0



**Casserole pot**

Casseruola bassa  
Bratentopf  
Sautoir  
Cacerola baja

art.	Ø cm.	h.	lt.
16109-24	24	9,5	4,3
16109-28	28	11,0	6,7
16109-32	32	12,5	10,0
16109-36	36	14,0	14,0
16109-40	40	16,0	20,0
16109-45	45	18,0	28,5
16109-50	50	19,0	37,0
16109-60	60	21,5	60,0



**Colander for stock pot**

Colapasta per pentola  
Seiher für Suppentopf  
Passoire pour marmite  
Colador para olla recta

art.	Ø cm.	h.
16926-32	32	31
16926-36	36	37
16926-40	40	40



**Couscous pan**

Couscoussiera  
Couscoustopf  
Couscoussier  
Cuscusera

art.	Ø cm.	h.	lt.
46970-18	36	22+17	18
46970-25	40	25+20	25



**Sauce-pot, aluminum**

Casseruola, alluminio  
Gemüsetopf, Aluminium  
Brasière, alu  
Cacerola, aluminio

art.	Ø cm.	h.	lt.
16929-36	36	17	17,0
16929-40	40	18	22,5



**Oval saucepan with cover**

Casseruola ovale con coperchio  
Ovale Kasserolle mit Deckel  
Casserole ovale avec couvercle  
Cacerola oval con tapa

art.	Ø cm.	h.	lt.
16938-36	36	14,5	10
16938-40	40	16,0	14
16938-45	45	17,0	19



**Saucepan**

Casseruola alta  
Stielkasserolle, hoch  
Casserole haute  
Cazo recto alto

art.	Ø cm.	h.	lt.
16106-16	16	11,0	2,1
16106-20	20	13,0	4,0
16106-24	24	15,0	6,5
16106-28	28	17,5	10,8



**Casserole pot**

Casseruola bassa  
Stielkasserolle, niedrig  
Sautoir  
Cacerola baja

art.	Ø cm.	h.	lt.
16108-20	20	8,0	2,5
16108-24	24	9,5	4,3
16108-28	28	11,0	6,7





**Frypan**  
Padella  
Bratpfanne  
Poêle à frire  
Sartén

art.	Ø cm.	h.
16114-20	20	4,0
16114-24	24	5,0
16114-28	28	5,0
16114-32	32	5,3
16114-36	36	6,0
16114-40	40	7,0



**French omelet pan**  
Tegame  
Servierpfanne  
Poêle à paella  
Paellera

art.	Ø cm.	h.
16115-24	24	5,5
16115-28	28	6,0
16115-32	32	6,5
16115-36	36	7,0
16115-40	40	7,5
16115-45	45	7,5



**Cover**  
Coperchio  
Deckel  
Couvercle  
Tapa

art.	Ø cm.
16961-16	16
16961-20	20
16961-24	24
16961-28	28
16961-32	32
16961-36	36
16961-40	40
16961-45	45
16961-50	50
16961-60	60





**Casserole pot, non stick**  
Casseruola alta, antiaderente  
Fleischtopf, nichttaftend  
Brasière, anti-adhérente  
Cacerola alta, antiadherente

art.	Ø cm.	h.	lt.
16127-16	16	11,0	2,1
16127-20	20	13,0	4,0
16127-24	24	15,0	6,5
16127-28	28	17,5	10,8
16127-32	32	19,5	15,7
16127-36	36	21,0	21,5
16127-40	40	24,0	30,0



**Casserole pot, non stick**  
Casseruola bassa, antiaderente  
Bratentopf, nichttaftend  
Sautoir , anti-adhérente  
Cacerola baja, antiadherente

art.	Ø cm.	h.	lt.
16120-24	24	9,5	4,3
16120-28	28	11,0	6,7
16120-32	32	12,5	10,0
16120-36	36	14,0	14,0
16120-40	40	16,0	20,0



**French omelet pan, non stick**  
Tegame, antiaderente  
Servierpfanne, nichttaftend  
Poêle à paella, anti-adhérente  
Paellera antiadherente

art.	Ø cm.	h.
16116-28	28	6,5
16116-32	32	6,5
16116-36	36	7,0
16116-40	40	7,5



**Frypan, non stick**  
Padella, antiaderente  
Bratpfanne, nichttaftend  
Poêle, anti-adhérente  
Sartén antiadherente

art.	Ø cm.	h.
41720-18	18	3,8
41720-20	20	3,8
41720-24	24	4,5
41720-28	28	5,4
41720-30	30	5,4
41720-32	32	5,6



**Frypan, non stick**  
Padella, antiaderente  
Bratpfanne, nichttaftend  
Poêle, anti-adhérente  
Sartén antiadherente

art.	Ø cm.	h.
16117-20	20	4,0
16117-24	24	5,0
16117-28	28	5,0
16117-32	32	5,3
16117-36	36	6,0
16117-40	40	7,0



**Forged frypan, non stick**  
Padella forgiata, antiaderente  
Pfanne, geschmiedet, nichttaftend  
Poêle forgée, anti-adhérente  
Sartén forjada, antiadherente

art.	Ø cm.	h.
11617-20	20	3,4
11617-24	24	4,2
11617-28	28	4,5
11617-32	32	5,5



**Frypan, non stick, cast iron handle**  
Padella bombata antiaderente, manico ferro  
Bratpfanne, nichttaftend, Gusseisen-Stiel  
Poêle bombé, anti-adhérente, queue fonte  
Sartén antiadherente, mango hierro

art.	Ø cm.	h.
16113-20	20	5,5
16113-24	24	6,5
16113-28	28	7,0
16113-32	32	7,5
16113-36	36	8,0
16113-40	40	8,5



**Frypan, non stick, cast iron handle**  
Padella antiaderente, manico ferro  
Bratpfanne, nichttaftend, Gusseisen-Stiel  
Poêle, anti-adhérente, queue fonte  
Sartén antiadherente, mango hierro

art.	Ø cm.	h.
16717-20	20	4,0
16717-24	24	5,0
16717-28	28	5,0
16717-32	32	5,3
16717-36	36	6,0
16717-40	40	7,0



**Crêpes pan, non stick**  
Padella crêpes, antiaderente  
Crêpepfanne, nichttaftend  
Poêle à crêpes, anti-adhérente  
Sartén crêpes antiadherente

art.	Ø cm.
16118-24	24



**Non-stick blinis pan**

Padella per blini, antiaderente  
Blinis-Pfännchen, nichttaftend  
Poêle à blinis, anti-adhérente  
Sartén blinis, antiadherente

art.	Ø cm.	h.
16719-12	12	2



**Crêpes pan, non-stick**

Padella crêpes antiaderente  
Crêpes-Pfanne, nichttaftend  
Tuile à crêpes anti-adhérente  
Sartén para crêpes, antiadherente

art.	Ø cm.
16712-22	22
16712-26	26
16712-30	30



**Bake roasting pan**

Tegame  
Pfanne  
Plat à four  
Rustidera

art.	cm.	h.
16941-40	40x26	7,5
16941-45	45x30	7,5
16941-50	50x30	8,0
16941-60	60x35	9,0
16941-61*	61x43	9,0

\*For 2/1 GN ovens. – Per forno GN 2/1.



**Bake roasting pan**

Tegame  
Pfanne  
Plat à four  
Rustidera

art.	cm.	h.
16943-40	40x26	7,5
16943-45	45x30	7,5
16943-50	50x30	8,0
16943-60	60x35	9,0
16943-61*	61x43	9,0

\*For 2/1 GN ovens. – Per forno GN 2/1.



**Bake roasting, non stick**

Tegame, antiaderente  
Pfanne, nichttaftend  
Plat à four, anti-adhérente  
Rustidera antiadherente

art.	cm.	h.
16947-40	40x26	7,5
16947-45	45x30	7,5
16947-50	50x30	8,0
16947-60	60x35	9,0
16947-61*	61x43	9,0

\*For 2/1 GN ovens. – Per forno GN 2/1.



**Lid for roasting pans**

Coperchio per tegami  
Deckel für Bräter  
Couvercle pour plaques à rôtir  
Tapa para rustidera

art.	cm.
16948-40	40x26
16948-45	45x30
16948-50	50x30
16948-60	60x35
16948-61	61x43



**Bake roasting pan**

Tegame basso  
Pfanne, flach  
Plat à four bas  
Bandeja horno

art.	cm.	h.
16944-45	45x30	4
16944-50	50x30	4
16944-60	60x35	4



**Roasting pan with cover**

Brasiera con coperchio  
Brasiera mit Deckel  
Braisière avec couvercle  
Rustidera alta con tapa

art.	cm.	h.	lt.
16965-40	40x26	15	14
16965-50	50x30	15	21
16965-60	60x35	15	30



**Fish kettle**

Pesciera  
Fisch-Kochkessel  
Poissonnière  
Hervidor pescado

art.	cm.	h.	lt.
16939-50	50x15	12	9
16939-60	60x17	13	13
16939-70	70x19	14	18
16939-80	80x24	17	30



**Bain-marie pot**

Bagnomaria  
Wasserbadkasserolle  
Casserole bain-marie  
Baño maria

art.	Ø cm.	h.	lt.
16910-14	14	16	2,5
16910-16	16	18	3,7
16910-18	18	20	5,0
16910-20	20	22	7,0

Equipped with grid and cover. – Fornita con griglia e coperchio.



# STEEL FRYING PANS PADELLE FERRO



Iron is ideal for cooking at high temperatures because its low capacity of heat transmission prevents temperature leaps. As it is non-stick, food does not stick to it. It withstands very high temperatures and improves its performance with use. Iron pans are perfect for fried food, omelettes or fine crêpes. Wash the black iron pan in water as little as possible and always keep it greased. Iron pans are ideal also for cooking on induction hobs.

Il ferro è ottimo per le cotture a fuoco molto vivo perché, non avendo un'alta capacità di trasmettere calore, evita improvvisi sbalzi di temperatura. Essendo un materiale antiaderente, evita l'attaccamento dei cibi. Sopporta temperature elevatissime e col tempo migliora il suo rendimento. I recipienti in ferro sono i più adatti per frittare, omelette o sottili crêpes. La padella in ferro nera va lavata con acqua il meno possibile e mantenuta sempre unta. Il ferro è il materiale ideale anche per cotture a induzione.





**Blacksteel fish pan**  
Padella ovale  
Fischeisenpfanne, oval  
Coupe ovale  
Sartén oval

art.	cm.	h.
41719-36	36x26	5,0
41719-40	40x28	5,5



**Blacksteel crêpes pan**  
Padella crêpes  
Crêpes Eisenpfanne  
Coupe lyonnaise à crêpes  
Sartén crêpes

art.	Ø cm.	h.
11718-20	20	2
11718-22	22	2
11718-24	24	2



**Blinis pan**  
Padella per blini  
Blinis-Eisenpfännchen  
Poêle à blinis  
Sartén blinis

art.	Ø cm.	h.
11715-12	12	2



**Heavy blacksteel frypan**  
Padella lionese, pesante  
Schwere Eisenpfanne  
Coupe lyonnaise extra-forte  
Sartén honda pesada

art.	Ø cm.	h.
11714-20	20	3,8
11714-22	22	4,0
11714-24	24	4,5
11714-26	26	4,5
11714-28	28	4,5
11714-32	32	5,0
11714-36	36	5,5
11714-40	40	5,5
11714-45	45	5,5
11714-50	50	6,0



**Blacksteel frypan**  
Padella lionese  
Eisenpfanne  
Coupe lyonnaise  
Sartén honda

art.	Ø cm.	h.
11716-16	16	4,0
11716-20	20	4,5
11716-22	22	4,5
11716-24	24	5,0
11716-26	26	5,5
11716-28	28	5,5
11716-32	32	6,0
11716-36	36	6,5
11716-40	40	7,0
11716-45	45	8,0



**Blacksteel paella pan**  
Padella per paella  
Paella Eisenpfanne  
Coupe lyonnaise à paella  
Paellera

art.	Ø cm.	h.
11717-34	34	5,0
11717-37	37	5,5
11717-42	42	6,0
11717-47	47	6,5
41717-60	60	6,5



**Blacksteel fish pan**  
Padella ovale  
Fischeisenpfanne, oval  
Coupe ovale  
Sartén oval

art.	cm.
41703-38	38x26



**Wok pan**  
Wok  
Wok-Pfanne  
Poêle chinoise  
Wok

art.	Ø cm.	h.
11713-32	32	10
11713-40	40	11



**Chestnut pan**  
Padella per castagne  
Kastanienpfanne  
Poêle à marrons  
Sartén para castañas

art.	Ø cm.
11721-28	28



**Silicone sleeve**  
Coprimanico silicone  
Silikon-Stielhülle  
Revêtement manche en silicone  
Cubre mango silicona

art.	Ø cm.	col.
11710-AA	20-36	●
11710-AB	40-50	●

Heat resistant up to 230°C. Resistenza al calore fino a 230°C. Suits items! Per art: 16717, 16113, 16712, 11714, 11716, 11718, 11713, 11721.



**Fry pan**  
Padella per friggere  
Frittier-Pfanne  
Tuile à frire  
Sartén freidora

art.	Ø cm.	h.	lt.
41707-32	32	9,8	6,0
41707-36	36	11,0	8,8
41707-40	40	13,4	12,2
41707-45	45	15,0	17,3
41707-50	50	17,6	23,5



**Wire basket, tinned**  
Cestello per friggere, stagnato  
Frittier-Rost, verzinkt  
Grille à frire, étamée  
Cesta escurrefrito, estañada

art.	Ø cm.	h.
41708-32	32	11,0
41708-36	36	11,5
41708-40	40	12,4
41708-45	45	15,5
41708-50	50	16,5

# SERIES 15500 3-PLY

COPPER COOKWARE  
PENTOLAME RAME

INDUCTION  
READY!



Ideal for cooking and serving from the kitchen to the table. A working tool with a body made of three metals, copper, aluminum and steel. A mix for a homogenous and sweet thermal spread that ensures cooking without attacking the foods, preserving its nutritional properties and organoleptic characteristics. Inside stainless steel, practical and easy to clean. Middle layer aluminum, lightweight and a very good heat conductor. Exterior glossy copper finishing, a tradition in the kitchen, fascinating and beautiful to see. Solid brass handles assembled with strong section rivets. Suitable for use on all cooking hobs including induction.

Ideale per cucinare e servire nello stesso recipiente. Uno strumento di lavoro con un corpo formato da tre metalli, rame, alluminio e acciaio. Un mix per un'omogenea e dolce diffusione termica che assicura una cottura senza aggredire i cibi, preservandone le proprietà nutrizionali e le caratteristiche organolettiche. Lamina interna in acciaio inox, pratico e facile da pulire. Strato intermedio in alluminio, leggero e ottimo conduttore di calore. Esterno in rame finitura lucida, una tradizione in cucina, affascinante e bello da vedere. Manici e maniglie in ottone massiccio assemblati con rivetti di forte sezione. Adatto ad uso su tutti i fuochi inclusa l'induzione.



**Saucepan**

Casseruola alta  
Stielkasserolle, hoch  
Casserole haute  
Cazo recto alto

art.	Ø cm.	h.	lt.
15506-16	16	8	1,6
15506-20	20	11	3,5
15506-24	24	14	6,3
15506-28	28	16	9,8



**Casserole pot**

Casseruola bassa  
Stielkasserolle, niedrig  
Sautoir  
Cacerola baja

art.	Ø cm.	h.	lt.
15508-20	20	7	2,2
15508-24	24	8	3,6
15508-28	28	9	5,5



**Frypan**

Padella  
Bratpfanne  
Poêle à frire  
Sartén

art.	Ø cm.	h.	lt.
15514-20	20	4,5	1,4
15514-24	24	4,5	2,0
15514-28	28	5,5	3,4
15514-32	32	6,0	4,8



**Saucepot**

Casseruola alta  
Fleischtopf  
Brasière  
Cacerola alta

art.	Ø cm.	h.	lt.
15507-16	16	8	1,6
15507-20	20	11	3,5
15507-24	24	14	6,3
15507-28	28	16	9,8



**Casserole pot**

Casseruola bassa  
Bratentopf  
Sautoir  
Cacerola baja

art.	Ø cm.	h.	lt.
15509-20	20	7	2,2
15509-24	24	8	3,6
15509-28	28	9	5,5



**Frypan**

Padella  
Bratpfanne  
Poêle à paella  
Paellera

art.	Ø cm.	h.	lt.
15515-20	20	4,5	1,4
15515-24	24	4,5	2,0
15515-28	28	5,5	3,4
15515-32	32	6,0	4,8



**Cover**

Coperchio  
Deckel  
Couvercle  
Tapa

art.	Ø cm.
15561-20	20
15561-24	24
15561-28	28



# MINI COOKWARE MINIATURE SERIES 15200

**COPPER COOKWARE 3-PLY**  
PENTOLAME RAME 3-PLY



**Paderno Serie 15200 3-ply, inside stainless steel satin polished, intermediate layer in aluminum, outside copper mirror polished. Thickness 1,8 mm. Stainless steel handles with PVD gold finishing, stainless steel rivets. For use on any heating element (except on induction hob).**

Serie Paderno 15200 3-ply, lamina interna in acciaio inox finitura satinata, strato intermedio in alluminio, esterno rame lucido. Spessore 1,8 mm. Manicatura in acciaio inox con finitura PVD oro, rivetti inox. Adatte ad uso su tutti i fuochi (eccetto induzione).



#### Saucepan

Casseruola alta  
Stielkasserolle, hoch  
Casserole haute  
Cazo recto alto

art.	Ø cm.	h.	lt.
15226-07	7	4,0	0,15
15228-10	10	4,5	0,35



#### Saucepan

Casseruola alta  
Stielkasserolle, hoch  
Casserole haute  
Cazo recto alto

art.	Ø cm.	h.	lt.
15226-10	10	7	0,50
15226-12	12	8	0,85
15226-14	14	9	1,30



#### Frypan

Padella  
Bratpfanne  
Poêle à paella  
Paellera

art.	Ø cm.	h.	lt.
15224-10	10	3,0	0,20
15224-12	12	3,5	0,35
15224-14	14	4,5	0,70



#### Saucepot

Casseruola alta  
Fleischtopf  
Brasière  
Cacerola alta

art.	Ø cm.	h.	lt.
15227-10	10	7	0,50
15227-12	12	8	0,85
15227-14	14	9	1,30



#### Casserole pot

Casseruola bassa  
Bratentopf  
Sautoir  
Cacerola baja

art.	Ø cm.	h.	lt.
15229-10	10	4,5	0,35



#### Omelet pan

Tegame  
Servierpfanne  
Poêle à paella  
Paellera

art.	Ø cm.	h.	lt.
15225-10	10	3,0	0,20
15225-12	12	3,5	0,35
15225-14	14	4,5	0,70



#### Cover

Coperchio  
Deckel  
Couvercle  
Tapa

art.	Ø cm.
15261-10	10
15261-12	12
15261-14	14







# SERIES 15300-15400

COPPER COOKWARE  
PENTOLAME RAME



Solid copper, thickness from 1,5 to 2,5 mm, the interiors are tinned over the fire by hand. Handles in highly polished solid brass, assembled with wide rivets. For use on any heating element (except on induction hob).

Rame massiccio, spessore da 1,5 a 2,5 mm internamente stagnato a mano sulla fiamma. Manici e maniglie in ottone massiccio lucidato a specchio ed assemblati con rivetti di forte sezione. Adatto ad uso su tutti i fuochi (eccetto induzione).



**Oval saucepan**  
Casseruola ovale  
Ovaler Bratentopf  
Casserole ovale  
Cacerola oval

art.	cm.	h.
15338-38	38x25	13



**Bake roasting pan**  
Tegame rettangolare  
Rechteckige Pfanne  
Plat à four  
Rustidera

art.	cm.	h.
15343-36	38x28	11



**Oval pan**  
Tegame ovale  
Ovale Bratpfanne  
Plat ovale à poignées  
Bandeja oval

art.	cm.	h.
15339-36	38x26	11



**Fish kettle**  
Pesciera  
Fischkochkessel  
Poissonnière  
Hervidor pescado

art.	cm.	h.
15438-50	50x18	11



**Bain-marie**  
Bagnomaria  
Wasserbadkasserolle  
Bain-marie  
Baño maría

art.	Ø cm.	h.
15403-16	16	17

**With porcelain. – Con porcellana.**



**Fondue set**  
Set fonduta  
Fondue-Service  
Service à fondue  
Servicio para fondues

art.	Ø cm.	h.
15430-11	16	26



**Sugar saucepan**  
Casseruola per zucchero  
Zuckerpfännchen  
Poelon à sucre  
Cacerola para azúcar

art.	Ø cm.	h.
15406-16	16	9
15406-20	20	10



**Zabaione bowl**  
Casseruola per zabaione  
Zabaionekasserolle  
Poelon à zabaione  
Cacerola sabayón

art.	Ø cm.
15407-16	16
15407-20	20



**Foot for zabaione bowl**  
Base per casseruola zabaione  
Fuss für Zabaionekasserolle  
Base pour poelon à zabaione  
Base para cacerola sabayón

art.	Ø cm.	h.
15401-51	8	4,5



**Mixing bowl**  
Bastardella semisferica  
Schnees Schlagkessel  
Bassine hémisphérique  
Caldero

art.	Ø cm.
15409-26	26
15409-30	30
15409-36	36



**Bordelais moulds**  
Stampo scanalato  
Bordelais-Kuchenform  
Moule à cannelés Bordelais  
Molde para bordelais

art.	Ø cm.	h. mm.
15415-03	5,5	5

**3 pcs set. – Set 3 pezzi.**



**Frosted finishing. – Finitura smerigliata.**



# MINI COOKWARE MINIATURE

COOKWARE  
PENTOLAME



Aluminum body non-stick coated, brass handles. A range of small pots ideal for side dishes and individual servings, soufflés, baked pasta, rice creams, raclette, savory as well as sweet pastries, desserts, etc., etc.. Versatile, functional, ready to be served from the kitchen to the table. Original and yet traditional, they come from the world of haute cuisine, ideal for enhancing creations or the most simple recipes, for the sake of conviviality, to give a more playful aspect to our meals.

Corpo in alluminio con rivestimento antiaderente, maniciatura in ottone. Una gamma di miniature ideali per contorni e singole porzioni, soufflé, pasta al forno, creme di riso, raclette, brioches salate e dolci, dessert, ecc., ecc.. Polivalenti, funzionali, pronte per essere servite dalla cucina alla tavola. Originali eppure tradizionali, provengono dal mondo dell'alta gastronomia, strumento ideale per valorizzare creazioni estrose o le più semplici ricette, per amore della convivialità, per donare un aspetto più ludico ai nostri pasti.



**Saucepan**

Casseruola alta  
Stielkasserole, hoch  
Casserole haute  
Cazo recto alto

art.	Ø cm.	h.	lt.
16136-10	10	6	0,45



**Sauté pan**

Casseruola bassa  
Stielkasserole, niedrig  
Plat à sauter  
Cazo recto bajo

art.	Ø cm.	h.	lt.
16138-10	10	4	0,3



**Frypan**

Padella  
Bratpfanne  
Poêle à frir  
Sartén

art.	Ø cm.	h.	lt.
16134-12	12	4	0,4



**Saucepan**

Casseruola alta  
Fleischtopf  
Casserole haute  
Cazo recto alto

art.	Ø cm.	h.	lt.
16137-10	10	6	0,45



**Casserole pot**

Casseruola bassa  
Bratentopf  
Sautoir  
Cacerola baja

art.	Ø cm.	h.	lt.
16139-10	10	4	0,3



**French omelet pan**

Tegamino  
Servierpfanne  
Poêle à paella  
Paellera

art.	Ø cm.	h.	lt.
16135-12	12	4	0,4



**Blinis pan, non-stick aluminum**

Padella blini, alluminio antiaderente  
Blinis-Pfännchen, Alu-Nichttaffend  
Poêle à blinis, alu anti-adhérente  
Sartén blinis, aluminio antiadherente

art.	Ø cm.	h.
16719-12	12	2



**Blinis pan, steel**

Padella blini, ferro  
Blinis-Pfännchen, Eisen  
Poêle à blinis, acier  
Sartén blinis, hierro

art.	Ø cm.	h.
11715-12	12	2



**Sauté pan with double spouts**

Casseruola con due becchi, 3-ply  
Stielkasserolle, niedrig, 2 Schnabel  
Plat à sauter, 2 becs  
Cazo recto bajo, 2 picos

art.	Ø cm.	h.	lt.
12511-10	10	5	0,4

**Mirror finishing. – Finitura lucida.**



**Sauté pan**

Casseruola bassa, 3-ply  
Stielkasserolle, niedrig  
Plat à sauter  
Cazo recto bajo

art.	Ø cm.	h.	lt.
12511-12	12	6	0,7

**Mirror finishing. – Finitura lucida.**



**Sauté pan**

Casseruola bassa, 3-ply  
Stielkasserolle, niedrig  
Plat à sauter  
Cazo recto bajo

art.	Ø cm.	h.	lt.
12511-14	14	7	1

**Mirror finishing. – Finitura lucida.**



**Saucepot with lid**

Casseruola con coperchio, 3-ply  
Fleischtopf mit Deckel  
Brasière avec couvercle  
Cacerola alta con tapa

art.	Ø cm.	h.	lt.
12509-12	12	6	0,7

**Mirror finishing. – Finitura lucida.**



**Saucepan, oval, Stoneware**

Casseruola ovale  
Kasserolle, oval  
Casserole, ovale  
Cacerola, oval

art.	cm.	h.
41210-03	13x8,2	3,9



**Saucepan, Stoneware**

Tegamimo  
Pfännchen  
Sautoir  
Fuente huevo

art.	Ø cm.	h.
41210-12	13	5
41210-13	15	5
41210-14	17	5



**Saucepan, rectangular, Stoneware**

Casseruola rettangolare  
Kasserolle, rechteckig  
Casserole, rectangulaire  
Cacerola, rectangular

art.	cm.	h.
41210-05	13x8,2	3,9



**Piepan, Stoneware**

Tortiera  
Kuchenform  
Ramequin  
Molde tarta

art.	Ø cm.	h.
41210-10	11	3,9



**Saucepan, round, Stoneware**

Casseruola tonda  
Kasserolle, rund  
Casserole, ronde  
Cacerola, redonda

art.	Ø cm.	h.
41210-01	13	3,9



**Saucepan with lid, Stoneware**

Casseruola con coperchio  
Kasserolle mit Deckel  
Casserole avec couvercle  
Cacerola con tapa

art.	Ø cm.	h.
41210-07	11,5	5,5
41210-08	13,0	7,5





# ENAMELLED CAST IRON GHISA SMALTATA

COOKWARE  
PENTOLAME



INDUCTION  
READY!



Suitable for use on all cooking hobs (gas, electric, ceramic, induction) and ovens (gas, oil, coal or wood) except microwave. A perfect harmony of cast iron, enamel and high quality. Designed and constructed to absorb and spread the heat evenly. Cast iron is suitable for all cooking techniques, for soups, roasts, rice, desserts, for braise that require a long cooking and likewise ideal for meats and grilled vegetables as it enhances flavors and aromas like barbecue style. Cast iron also features non-stick. The high temperature of the pan sears the meat surface. All the flavor, water and nutritional values remain sealed in the food. When cooking in casseroles, the steam generated thanks to the special design of the cover condenses falling back into the food not only retaining flavors and aromas but providing the best protection for nutrients and contributing to a healthy diet. Cast iron is a material 100% recyclable and therefore environmentally friendly. Moreover, thanks to its ability to retain heat for a long time it allows a considerable saving of energy. With closed lid on the table, the pot will preserve the temperature for a second serving. Cast iron retains the heat but as well the cold... can be used to keep the food fresh. Stored for a short time in the refrigerator, keeps food cool during hot summer days, ideal for serving pasta or rice salads, etc. Practical and easy to clean. These cast iron pots and pans are dishwasher safe thanks to the special technology applied to their enameling method. Ergonomic knobs and handles made of cast iron and stainless steel, suitable for use on all heat sources and ovens except microwave. Be careful, they heat up during cooking, it is recommended to handle with a dry thick cloth.

Idonee all'uso su tutte le fonti di cottura (gas, elettriche, vetroceramica, induzione) e forni (gas, petrolio, carbone o legna) ad esclusione di microonde. Una perfetta armonia tra ghisa, smalto e alta qualità. Progettate e costruite per assorbire e diffondere il calore in modo uniforme. La ghisa è adatta a tutte le tecniche di cottura, per zuppe, arrostiti, risotti, dolci, per piatti che richiedono una lunga cottura tipo brasati e allo stesso modo ideale per carni e verdure alla griglia in quanto ne esalta sapori ed aromi in stile barbecue. La ghisa ha anche caratteristiche di antiaderenza. La temperatura elevata della padella cauterizza la superficie della carne. Tutto il sapore, l'acqua e i valori nutrizionali rimangono sigillati nel cibo. Nella cottura in casseruole, il vapore generato grazie al particolare design del coperchio si condensa ricadendo e mescolandosi nuovamente nel cibo non solo trattenendo sapori e aromi ma fornendo la miglior protezione alle sostanze nutrienti e contribuendo ad una dieta sana. La ghisa è un materiale riciclabile al 100% e quindi ecologico. Inoltre, grazie alla sua capacità di mantenere il calore per lungo tempo consente un notevole risparmio di energia permettendo di cuocere a fuoco basso. Anche a tavola mantengono in cibi in temperatura. La ghisa mantiene però il caldo come pure il freddo... può essere usata per mantenere il cibo fresco. Riposta per un breve periodo in frigorifero, mantiene il cibo fresco nelle calde giornate estive e ideale per servire insalate di pasta, riso, farro, ecc., ecc. Pratica e facile da pulire. Queste casseruole e padelle in ghisa sono lavabili in lavastoviglie, per merito della speciale tecnologia applicata al metodo di smaltatura. Manicatura e pomoli dal design ergonomico sono in ghisa e inox. Durante la cottura si raccomanda di maneggiare con un panno consistente e asciutto per evitare di scottarsi.



**Saucepot round with lid**  
Casseruola tonda con coperchio  
Fleischtopf, rund mit Deckel  
Brasière avec couvercle  
Cacerola redonda con tapa

art.	Ø cm.	lt.	col.
44201R10	10	0,35	●
44201V10	10	0,35	●
44201B10	10	0,35	●
44201O10	10	0,35	●
44201N10	10	0,35	●

**Portion:** – Porzioni: 1



**Saucepot round with lid**  
Casseruola tonda con coperchio  
Fleischtopf, rund mit Deckel  
Brasière avec couvercle  
Cacerola redonda con tapa

art.	Ø cm.	lt.	col.
44201R12	12	0,55	●
44201V12	12	0,55	●
44201B12	12	0,55	●
44201O12	12	0,55	●
44201N12	12	0,55	●

**Portion:** – Porzioni: 1



**Oval saucepan with lid**  
Casseruola ovale con coperchio  
Ovaler Bratentopf mit Deckel  
Casserole ovale avec couvercle  
Cacerola oval con tapa

art.	cm.	col.
44202R12	12x9x6	●
44202N12	12x9x6	●

**Portion:** – Porzioni: 1



**W**

**Saucepot stand**  
Supporto casseruolina  
Fleischtopf-Träger  
Support pour brasière  
Soporte para cacerola

art.	Ø cm.
44201-01	10



**W**

**Saucepot stand**  
Supporto casseruolina  
Fleischtopf-Träger  
Support pour brasière  
Soporte para cacerola

art.	Ø cm.
44201-03	10



**W**

**Saucepot platter**  
Sottopentola  
Fleischtopfbrett  
Planche à casserole  
Tabla para cacerola

art.	Ø cm.
44201-10	10-12



**W**

**Saucepot platter**  
Sottopentola  
Fleischtopfbrett  
Planche à casserole  
Tabla para cacerola

art.	cm.
44202-10	12x9



**Soufflé pot with wooden platter**  
Coppa soufflé con piatto legno  
Ramekin mit Holzbrett  
Ramequin avec planche bois  
Fuente soufflé con tabla madera

art.	Ø cm.	lt.
44240S08	8	0,17

**Portion:** – Porzioni: 1



**W**

**Platter with magnetic feature**  
Sottopentola magnetico  
Untersetzer, magnetisch  
Sous-plat magnétique  
Posavasos magnético

art.	Ø cm.
44207-20	20



**Silicone sleeves**  
Coprigraniglie silicone  
Silikon-Griffhüllen  
Revêtement en silicone pour poignées  
Cubre asas de silicona

art.	col.
44208G00	●
44208R00	●



**Saucepot with lid**  
Casseruola alta con coperchio  
Fleischtopf mit Deckel  
Brasière avec couvercle  
Cacerola alta con tapa

art.	Ø cm.	lt.	Por.
44201R16	16	1,0	1-2
44201R20	20	2,6	2-3
44201R24	24	4,5	4-5
44201R28	28	6,7	6-8
44201R32	32	10,0	12-16



**Saucepot with lid**

Casseruola alta con coperchio  
Fleischtopf mit Deckel  
Brasière avec couvercle  
Cacerola alta con tapa

art.	Ø cm.	lt.	Por.
44201N16	16	1,0	1-2
44201N20	20	2,6	2-3
44201N24	24	4,5	4-5
44201N28	28	6,7	6-8
44201N32	32	10,0	12-16



**Oval saucepan with lid**

Casseruola ovale con coperchio  
Ovaler Bratentopf mit Deckel  
Casserole ovale avec couvercle  
Cacerola oval con tapa

art.	Ø cm.	lt.	Por.
44202R29	29	4,8	6



**Oval saucepan with lid**

Casseruola ovale con coperchio  
Ovaler Bratentopf mit Deckel  
Casserole ovale avec couvercle  
Cacerola oval con tapa

art.	Ø cm.	lt.	Por.
44202N25	25	3,3	4
44202N29	29	4,8	6



**Casserole pot with glass lid**

Casseruola bassa coperchio vetro  
Bratentopf mit Glasdeckel  
Sautoir avec couvercle verre  
Cacerola baja con tapa vidrio

art.	Ø cm.	lt.	Por.
44204R24	24	2,4	4
44204R28	28	3,4	4-6



**Grill pan**

Padella grill  
Grill-Pfanne  
Poêle grill  
Sartén grill

art.	cm.	lt.	Por.
44209R26	26x26	2,2	4
44209R32	26x32	2,6	6



**Grill pan**

Padella grill  
Grill-Pfanne  
Poêle grill  
Sartén grill

art.	cm.	lt.	Por.
44210-26	26x26	2,20	4
44210-32	26x32	2,75	6



**Grill pan with wooden service stand**

Padella grill con tagliere a servire legno  
Grill-Pfanne mit Service-Holzbrett  
Poêle grill avec support à servir bois  
Sartén grill con tabla madera

art.	cm.	lt.	Por.
44210S32	26x32	2,75	6



**Grill pan**

Padella grill  
Grill-Pfanne  
Poêle grill  
Sartén grill

art.	cm.	lt.	Por.
44210-42	31x42	4,5	8



**Bake roasting dish**

Tegame rettangolare  
Pfanne, rechteckig  
Plat rectangulaire  
Rustidera

art.	cm.	Por.
44218R30	22x30	6-8
44218R40	26x40	8-12



**Terrine pot**

Terrina  
Pasteten-Pfanne  
Terrine rectangle  
Fuente rectangular

art.	cm.	Por.
44219R26	8,5x26,5x6	2-4



**Grill pan**

Bistecchiera  
Grill-Pfanne  
Poêle grill  
Sartén grill

art.	cm.	Por.
44213-24	24x24	1-2
44213-36	21x36	2-4





**Grill pan**

Bistecchiera  
Grill-Pfanne  
Poêle grill  
Sartén grill

art.	Ø cm.	Por.
44214-25	25	2-3



**Grill pan**

Bistecchiera  
Grill-Pfanne  
Poêle grill  
Sartén grill

art.	Ø cm.	lt.	Por.
44212-30	30	2,35	4-6



**Griddle plate, dual side, reversible**

Griglia reversibile  
Grill-Platte, zweiseitig, reversible  
Grill rectangle, reversible  
Parrilla reversible

art.	cm.	Por.
44224-22	22x15	1-2



**Griddle plate, dual side, reversible**

Griglia reversibile  
Grill-Platte, zweiseitig, reversible  
Grill rectangle, reversible  
Parrilla reversible

art.	cm.	Por.
44217-45	26x47	6-8



**Grill plate and wooden platter**

Griglia reversibile con tagliere legno  
Grill-Platte mit Service-Holzbrett  
Grill avec plache à servir bois  
Parrilla con tabla madera

art.	cm.	Por.
44224S22	22x15	1-2

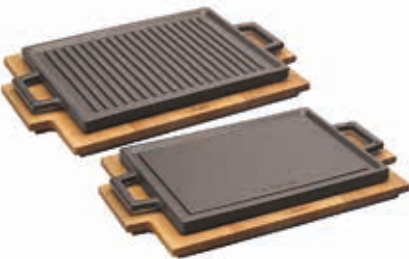

**Griddle with wooden platter**

Griglia con tagliere legno  
Grill-Platte mit Holzbrett  
Grill rectangle avec planche bois  
Parrilla con tabla madera

art.	cm.	Por.
44226S30	22x30	2-3



**Table barbecue**

Barbecue da tavola  
Tischgrillplatte  
Barbecue de table  
Parrilla de mesa

art.	cm.	Por.
44227-30	22x30	2-3



**Table barbecue**

Barbecue da tavola  
Tischgrillplatte  
Barbecue de table  
Parrilla de mesa

art.	cm.	Por.
44225-22	22x15	1-2



**Grill pan and wooden service stand**

Padella grill con tagliere a servire legno  
Grill-Pfanne mit Service-Holzbrett  
Poêle grill avec plache à servir bois  
Sartén grill con tabla madera

art.	cm.	Por.
44216S16	16x16	1

**Cups not included. – Ciotoline non incluse.**





**Grill pan with wooden platter**  
Padella grill con tagliere legno  
Grill-Pfanne mit Holzbrett  
Poêle grill avec plaque bois  
Sartén grill con tabla madera

art.	cm.	Por.
44215S16	16x16	1



**Fish plate with wooden platter**  
Piatto pesce con tagliere legno  
Fischplatte mit Holzbrett  
Plat à poisson avec planche bois  
Fuente pescado con tabla madera

art.	cm.	Por.
44221S30	15,5x29,5	1-2



**Fish plate with wooden platter**  
Piatto pesce con tagliere legno  
Fischplatte mit Holzbrett  
Plat à poisson avec planche bois  
Fuente pescado con tabla madera

art.	cm.	Por.
44220S24	15x24	1-2



**Pizza pan with wooden platter**  
Piatto pizza con tagliere legno  
Pizza-Platte mit Holzbrett  
Plat à pizza avec planche bois  
Fuente para pizza con tabla madera

art.	Ø cm.	Por.
44222S20	20	1
44222S28	28	1



**Fajita plate with wooden platter**  
Piatto fajita con tagliere legno  
Fajitaplatte mit Holzbrett  
Plat à fajitas avec planche bois  
Fuente fajitas con tabla madera

art.	cm.	Por.
44228S23	17x23	1



**Oval plate with wooden platter**  
Piatto ovale con tagliere legno  
Ovalplatte mit Holzbrett  
Plat oval avec planche bois  
Fuente ovale con tabla madera

art.	cm.	Por.
44230S14	21x14x2,5	1-2



**Round plate with wooden platter**  
Piatto tondo con tagliere legno  
Platte mit Holzbrett, rund  
Plat rond avec planche bois  
Fuente redonda con tabla madera

art.	Ø cm.	Por.
44232S16	16	1-2
44232S20	20	2-3



**Round plate with wooden platter**  
Piatto tondo con tagliere legno  
Platte mit Holzbrett, rund  
Plat rond avec planche bois  
Fuente redonda con tabla madera

art.	Ø cm.	lt.	Por.
44233-20	20	0,74	3-4

**Cups not included.** – Ciotoline non incluse.



**Round pan**  
Padella tonda  
Pfanne, rund  
Poêle ronde  
Sartén grill redonda

art.	Ø cm.	Por.
44234-12	12	1
44234-16	16	1-2



**Pan and wooden platter**  
Padella con tagliere legno  
Pfanne mit Holzbrett  
Poêle avec planche bois  
Sartén grill con tabla madera

art.	Ø cm.	lt.	Por.
44234S16	16	0,45	1-2



**Rectangular pan with wooden service stand**

Tegame con tagliere a servire legno  
Pfanne mit Service-Holzbrett  
Poêle avec support à servir bois  
Sartén con tabla madera

art. cm. Por.  
44237S15 12x15 1-2



**Service dish with wooden stand**

Piatto servire con tagliere legno  
Servierplatte mit Holzbrett  
Plat à servir avec support en bois  
Plato para servir con tabla madera

art. cm. Por.  
44245S32 32x20 1



**Service dish with wooden stand**

Piatto servire con tagliere legno  
Servierplatte mit Holzbrett  
Plat à servir avec support en bois  
Plato para servir con tabla madera

art. cm. Por.  
44244S36 36x24 4-6



**Pan with wooden platter**

Tegame con tagliere legno  
Pfanne mit Holzbrett  
Poêle avec plache bois  
Paellera con tabla madera

art. Ø cm. cm. lt. Por.  
44247S16 16 23,5x18,5 0,44 1-2



**Hot pot with wooden stand**

Casseruola con tagliere legno  
Schüssel mit Holzbrett  
Bol avec support en bois  
Bol con tabla madera

art. Ø cm. h. lt. Por.  
44246S14 14 4 0,32 1  
44246S17 17 4 0,59 1



**Tortillas cup**

Ciotola tortillas  
Tortillas-Schale  
Coupe-tortillas  
Copa tortillas

art. Ø cm.  
44241-19 19

**W**



**Soufflé pot, enameled cast iron**

Coppa soufflé, ghisa smaltata  
Ramekin, emailliertes Gusseisen  
Ramequin, fonte émaillée  
Fuente soufflé, hierro fundido esmaltado

art. Ø cm. lt. Por.  
44240-08 8 0,15 1



**PR**

**Sauce bowl**

Coppa salsa  
Saucentasse  
Bol à sauce  
Copa para salsa

art. Ø cm. h.  
44242-00 6 2,7



**MF**

**Sauce bowl**

Coppa salsa  
Saucentasse  
Bol à sauce  
Copa para salsa

art. Ø cm. h.  
44243-00 7,1 3,5

# OVEN COOKING DISHES PIROFILE FORNO

PORCELAIN  
PORCELLANA



Only use in the oven or microwave oven, do not place them on direct flame.

Per uso in forni tradizionali e microonde, non mettere le porcellane a diretto contatto con la fiamma.





**Oval dish, fluted**

Pirofila ovale cordonata  
Schale, oval, gerippt  
Plat ovale, cannelé  
Fuente oval borderizata

art.	cm.
44371-24	24x14x4
44371-28	28x16x4,5
44371-32	32,5x18x5
44371-36	36,5x19,5x5
44371-40	41x23x5,5
44371-44	44x26,5x5,7
44371-48	48x28,5x6,5



**Round dish, fluted**

Pirofila rotonda cordonata  
Schale, rund, gerippt  
Plat rond, cannelé  
Fuente redonda borderizata

art.	Ø cm.
44372-26	26,5
44372-32	32,0
44372-36	36,0
44372-40	40,0



**Rectangular dish, fluted**

Pirofila rettangolare cordonata  
Schale, rechteckig, gerippt  
Plat rectangulaire, cannelé  
Fuente rectangular borderizata

art.	cm.
44374-22	22x16x6
44374-25	25x20x7
44374-32	32x22x6
44374-36	36x24x6
44374-40	40x26x6
44374-44	44x32x6



**Oval dish, high, fluted**

Pirofila ovale cordonata, alta  
Schale, oval, gerippt  
Plat oval, cannelé  
Fuente oval borderizata, alta

art.	cm.
44389-32	32x22x8,5



**Rectangular dish, low, fluted**

Rettangolare cordonata, bassa  
Schale, rechteckig, flach, gerippt  
Plat rectangulaire, cannelé  
Fuente rect. borderizata, baja

art.	cm.
44376-40	40x30x4



**Square dish, fluted**

Pirofila quadra cordonata  
Schale, quadratisch, gerippt  
Plat carré, cannelé  
Fuente cuadrada borderizata

art.	cm.
44375-25	25x25x6



**Egg dish, fluted**

Tegamino cordonato  
Schale, gerippt  
Plat à oeufs, cannelé  
Fuente huevo borderizata

art.	cm.
44394-18	18x21,0
44394-21	21x24,5



**Creme broulée bowl**

Coppetta creme broulée  
Crème broulée Schale  
Coupelle broulée à crème  
Bol creme broulée

art.	Ø cm.	h.
44391-12	11,6	3



**Egg dish, high, fluted**

Tegamino fondo, cordonato  
Schale, tief, gerippt  
Plat oeuf, creux, cannelé  
Fuente huevo borderizata, alta

art.	cm.
44395-18	18x20



**Soup bowl with cover**

Casseruola con coperchio  
Kasserolle mit Deckel  
Casserole avec couvercle  
Cacerola con tapa

art.	cm.	lt.
44397-18	14x18	0,5



**Ramekin, fluted**

Soufflé cordonato  
Ramekin, gerippt  
Ramequin, cannelé  
Fuente soufflé borderizata

art.	Ø cm.	h.
44390-07	7	4,0
44390-09	9	4,5
44390-11	11	6,0



**Ramekin, fluted**

Soufflé cordonato  
Ramekin, gerippt  
Ramequin, cannelé  
Fuente soufflé borderizata

art.	Ø cm.	h.
44390-15	15	5,0
44390-18	18	7,5
44390-23	23	8,0



# GN FOOD PANS CONTENITORI GN

STAINLESS STEEL, ALUMINUM, POLYCARBONATE, POLYPROPYLENE, MELAMINE AND PORCELAIN  
INOX, ALLUMINIO, POLICARBONATO, POLIPROPILENE, MELAMINA E PORCELLANA



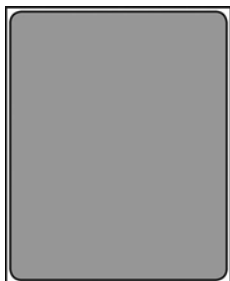

**GN-containers**

GN bacinelle  
GN-Behälter  
GN bacs  
GN cubetas



art.	GN	dim. mm.	h. mm.	lt.
14101-02	2/1	650x530	20	-
14101-04	2/1	650x530	40	-
14101-06	2/1	650x530	65	19
14101-10	2/1	650x530	100	31
14101-15	2/1	650x530	150	46
14101-20	2/1	650x530	200	56



art.	GN	dim. mm.	h. mm.	lt.
14102-02	1/1	530x325	20	-
14102-04	1/1	530x325	40	-
14102-06	1/1	530x325	65	9
14102-10	1/1	530x325	100	14
14102-15	1/1	530x325	150	21
14102-20	1/1	530x325	200	28





art.	GN	dim. mm.	h. mm.	lt.
14103-02	2/3	353x320	20	-
14103-04	2/3	353x320	40	-
14103-06	2/3	353x320	65	5,5
14103-10	2/3	353x320	100	9,0
14103-15	2/3	353x320	150	13,0
14103-20	2/3	353x320	200	18,0

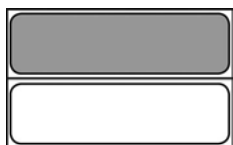

art.	GN	dim. mm.	h. mm.	lt.
14104-06	2/4	162x530	65	4,0
14104-10	2/4	162x530	100	5,6
14104-15	2/4	162x530	150	8,7



art.	GN	dim. mm.	h. mm.	lt.
14105-02	1/2	325x265	20	-
14105-04	1/2	325x265	40	-
14105-06	1/2	325x265	65	4,0
14105-10	1/2	325x265	100	6,5
14105-15	1/2	325x265	150	9,5
14105-20	1/2	325x265	200	12,5

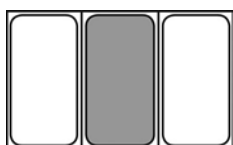

art.	GN	dim. mm.	h. mm.	lt.
14107-06	1/3	325x180	65	2,5
14107-10	1/3	325x180	100	4,0
14107-15	1/3	325x180	150	5,7
14107-20	1/3	325x180	200	7,8



art.	GN	dim. mm.	h. mm.	lt.
14108-06	1/4	265x160	65	1,8
14108-10	1/4	265x160	100	2,8
14108-15	1/4	265x160	150	4,0
14108-20	1/4	265x160	200	5,5



art.	GN	dim. mm.	h. mm.	lt.
14109-06	1/6	176x160	65	1,0
14109-10	1/6	176x160	100	1,6
14109-15	1/6	176x160	150	2,4
14109-20	1/6	176x160	200	3,4



art.	GN	dim. mm.	h. mm.	lt.
14110-06	1/9	176x110	65	0,6
14110-10	1/9	176x110	100	1,0



**GN-containers, fixed handles**

GN bacinelle, maniglie fisse

GN-Behälter mit festen Griffen

GN bacs, anses fixes

GN cubetas, asas fijas

art.	GN	dim. mm.	h. mm.	lt.
14112-10	1/1	530x325	100	14,0
14112-15	1/1	530x325	150	21,0
14112-20	1/1	530x325	200	28,0





art.	GN	dim. mm.	h. mm.	lt.
14115-10	1/2	325x265	100	6,5
14115-15	1/2	325x265	150	9,5
14115-20	1/2	325x265	200	12,5

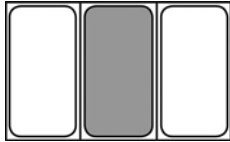

art.	GN	dim. mm.	h. mm.	lt.
14117-10	1/3	325x180	100	4,0
14117-15	1/3	325x180	150	5,7
14117-20	1/3	325x180	200	7,8



art.	GN	dim. mm.	h. mm.	lt.
14118-10	1/4	265x160	100	2,8
14118-15	1/4	265x160	150	4,0
14118-20	1/4	265x160	200	5,5

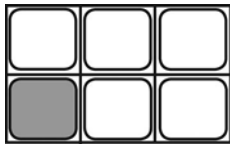

art.	GN	dim. mm.	h. mm.	lt.
14119-10	1/6	176x160	100	1,6
14119-15	1/6	176x160	150	2,4



**GN-containers, internal handles**  
GN bacinelle, maniglie interne  
GN-Behälter mit Innen Griffen  
GN bacs, anses internes  
GN cubetas, asas internas



art.	GN	dim. mm.	h. mm.	lt.
14142-10	1/1	530x325	100	14,0
14142-15	1/1	530x325	150	21,0
14142-20	1/1	530x325	200	28,0



art.	GN	dim. mm.	h. mm.	lt.
14145-10	1/2	325x265	100	6,5
14145-15	1/2	325x265	150	9,5
14145-20	1/2	325x265	200	12,5

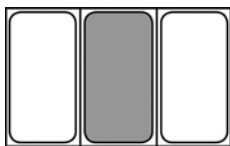

art.	GN	dim. mm.	h. mm.	lt.
14147-10	1/3	325x180	100	4,0
14147-15	1/3	325x180	150	5,7
14147-20	1/3	325x180	200	7,8



art.	GN	dim. mm.	h. mm.	lt.
14148-10	1/4	265x160	100	2,8
14148-15	1/4	265x160	150	4,0
14148-20	1/4	265x160	200	5,5



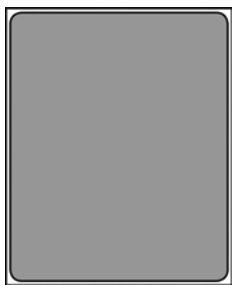

**GN-containers, falling handles**  
GN bacinelle, maniglie rientranti  
GN-Behälter mit versenkbaren Griffen  
GN bacs, anses escamotables  
GN cubetas, asas móviles



art.	GN	dim. mm.	h. mm.	lt.
14151-10	2/1	650x530	100	31,0
14151-15	2/1	650x530	150	46,0
14151-20	2/1	650x530	200	56,0



art.	GN	dim. mm.	h. mm.	lt.
14152-06	1/1	530x325	65	9,0
14152-10	1/1	530x325	100	14,0
14152-15	1/1	530x325	150	21,0
14152-20	1/1	530x325	200	28,0



art.	GN	dim. mm.	h. mm.	lt.
14155-10	1/2	325x265	100	6,5
14155-15	1/2	325x265	150	9,5
14155-20	1/2	325x265	200	12,5

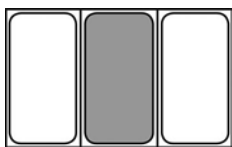

art.	GN	dim. mm.	h. mm.	lt.
14157-10	1/3	325x180	100	4,0
14157-15	1/3	325x180	150	5,7
14157-20	1/3	325x180	200	7,8



art.	GN	dim. mm.	h. mm.	lt.
14158-10	1/4	265x160	100	2,8
14158-15	1/4	265x160	150	4,0
14158-20	1/4	265x160	200	5,5



art.	GN	dim. mm.	h. mm.	lt.
14159-10	1/6	176x160	100	1,6
14159-15	1/6	176x160	150	2,4
14159-20	1/6	176x160	200	3,4



**GN-containers non stick coated**  
GN bacinelle antiaderenti  
GN-Behälter mit Antihafbeschichtung  
GN-bacs avec revêtement anti-adhésif  
GN-cubetas con cobertura antiadherente



art.	GN	dim. mm.	h. mm.
14162-02	1/1	530x325	20
14162-04	1/1	530x325	40
14162-06	1/1	530x325	65



art.	GN	dim. mm.	h. mm.
14165-02	1/2	325x265	20
14165-04	1/2	325x265	40
14165-06	1/2	325x265	65

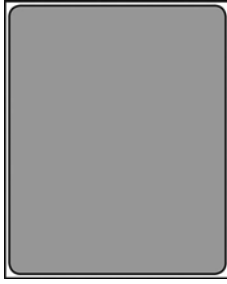

**Perforated GN-containers**

GN bacinelle forate  
Gelochte GN-Behälter  
GN bacs perforés  
GN cubetas perforados



art.	GN	dim. mm.	h. mm.
14201-02	2/1	650x530	20
14201-04	2/1	650x530	40
14201-06	2/1	650x530	65
14201-10	2/1	650x530	100
14201-15	2/1	650x530	150
14201-20	2/1	650x530	200

**Containers depth mm 20 and 40 only bottom perforated.** – Bacinelle profondità mm 20 e 40 forate solo sul fondo.



art.	GN	dim. mm.	h. mm.
14202-02	1/1	530x325	20
14202-04	1/1	530x325	40
14202-06	1/1	530x325	65
14202-10	1/1	530x325	100
14202-15	1/1	530x325	150
14202-20	1/1	530x325	200

**Containers depth mm 20 and 40 only bottom perforated.** – Bacinelle profondità mm 20 e 40 forate solo sul fondo.



art.	GN	dim. mm.	h. mm.
14203-06	2/3	353x320	65
14203-10	2/3	353x320	100
14203-15	2/3	353x320	150
14203-20	2/3	353x320	200

**Containers depth mm 20 and 40 only bottom perforated.** – Bacinelle profondità mm 20 e 40 forate solo sul fondo.



art.	GN	dim. mm.	h. mm.
14205-02	1/2	325x265	20
14205-04	1/2	325x265	40
14205-06	1/2	325x265	65
14205-10	1/2	325x265	100
14205-15	1/2	325x265	150
14205-20	1/2	325x265	200

**Containers depth mm 20 and 40 only bottom perforated.** – Bacinelle profondità mm 20 e 40 forate solo sul fondo.



**Perforated GN-containers, folding handles**

GN bacinelle forate, maniglie snodate  
Gelochte GN-Behälter mit Fallgriffen  
GN bacs perforés, anses pliantes  
GN cubetas perforados, asas plegables

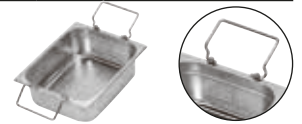

art.	GN	dim. mm.	h. mm.
14252-06	1/1	530x325	65
14252-10	1/1	530x325	100
14252-15	1/1	530x325	150
14252-20	1/1	530x325	200



art.	GN	dim. mm.	h. mm.
14255-06	1/2	325x265	65
14255-10	1/2	325x265	100
14255-15	1/2	325x265	150
14255-20	1/2	325x265	200



**GN-lids**

GN coperchi  
GN-Deckel  
GN couvercles  
GN tapas

art.	GN	dim. mm.
14502-00	1/1	530x325
14503-00	2/3	353x320
14504-00	2/4	162x530
14505-00	1/2	325x265
14507-00	1/3	325x180
14508-00	1/4	265x160
14509-00	1/6	176x160
14510-00	1/9	176x110



**GN-lids with notched edge for handles**

GN coperchi con spacco maniglie  
GN-Deckel mit Griffen-Ausschnitt  
GN couvercles avec encoche pour anses  
GN tapas con orificio asas

art.	GN	dim. mm.
14512-00	1/1	530x325
14515-00	1/2	325x265
14517-00	1/3	325x180
14518-00	1/4	265x160
14519-00	1/6	176x160



**GN-lids with notched edge for ladle**

GN coperchi con spacco mestolo  
GN-Deckel mit Löffel-Ausschnitt  
GN couvercles avec encoche pour louche  
GN tapas con orificio cacillo

art.	GN	dim. mm.
14522-00	1/1	530x325
14523-00	2/3	353x320
14525-00	1/2	325x265
14527-00	1/3	325x180
14528-00	1/4	265x160
14529-00	1/6	176x160



**GN-lids with notched edge for handles/ladle**

GN coperchi con spacco maniglie/mestolo  
GN-Deckel mit Griffen u. Löffel-Ausschnitt  
GN couvercles avec encoche pour anses/louche  
GN tapas con orificio asas/cacillo

art.	GN	dim. mm.
14532-00	1/1	530x325
14535-00	1/2	325x265
14537-00	1/3	325x180
14538-00	1/4	265x160
14539-00	1/6	176x160



**GN-lids with silicone seal**

GN coperchi con guarnizione silicone  
GN-Deckel mit Silikondichtung  
GN couvercles avec joint silicone  
GN tapas con junta de silicona

art.	GN	dim. mm.
14542-00	1/1	530x325
14543-00	2/3	353x320
14545-00	1/2	325x265
14547-00	1/3	325x180
14548-00	1/4	265x160
14549-00	1/6	176x160





**GN-lids with notched edge for handles and seal**  
GN coperchi con spacco maniglie e guarnizione  
GN-Deckel mit Griffen-Ausschnitt u. Silikondichtung  
GN couvercles avec encoche pour anses et joint  
GN tapas con orificio asas y junta

art.	GN	dim. mm.
14552-00	1/1	530x325
14555-00	1/2	325x265

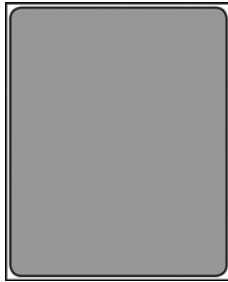

**GN-baking sheets**

GN-teglie  
GN-Backbleche  
GN-plaques  
GN-bandejas



art.	GN	dim. mm.	h. mm.
14301-02	2/1	650x530	20
14301-04	2/1	650x530	40
14301-06	2/1	650x530	65



art.	GN	dim. mm.	h. mm.
14302-02	1/1	530x325	20
14302-04	1/1	530x325	40
14302-06	1/1	530x325	65

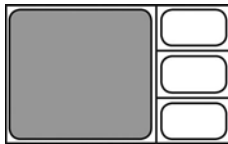

art.	GN	dim. mm.	h. mm.
14303-02	2/3	353x320	20
14303-04	2/3	353x320	40
14303-06	2/3	353x320	65



art.	GN	dim. mm.	h. mm.
14305-02	1/2	325x265	20
14305-04	1/2	325x265	40
14305-06	1/2	325x265	65



**GN-baking sheets non stick coated**

GN-teglie con rivestimento antiaderente  
GN-Backbleche mit Antihftbeschichtung  
GN-plaques avec revêtement anti-adhésif  
GN-bandejas con cobertura antiadherente



art.	GN	dim. mm.	h. mm.
14362-02	1/1	530x325	20
14362-04	1/1	530x325	40
14362-06	1/1	530x325	65



art.	GN	dim. mm.	h. mm.
14365-02	1/2	325x265	20
14365-04	1/2	325x265	40
14365-06	1/2	325x265	65





**GN-baking sheets, ALUMINIUM**

GN-teglie, ALLUMINIO  
GN-Backbleche, ALUMINIUM  
GN-plaques, ALUMINIUM  
GN-bandejas, ALUMINIO



art.	GN	dim. mm.	h. mm.
16302-02	1/1	530x325	20
16302-04	1/1	530x325	40
16302-06	1/1	530x325	65

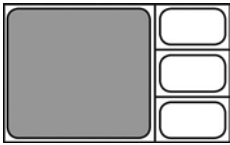

art.	GN	dim. mm.	h. mm.
16303-02	2/3	353x320	20
16303-04	2/3	353x320	40
16303-06	2/3	353x320	65



art.	GN	dim. mm.	h. mm.
16305-02	1/2	325x265	20
16305-04	1/2	325x265	40
16305-06	1/2	325x265	65



**GN-baking sheets, ALUMINIUM non stick coated**

GN-teglie, ALLUMINIO antiaderente  
GN-Backbleche, ALUMINIUM mit Antihafbeschichtung  
GN-plaques, ALUMINIUM avec revêtement anti-adhésif  
GN-bandejas, ALUMINIO con cobertura antiadherente



art.	GN	dim. mm.	h. mm.
16362-02	1/1	530x325	20
16362-04	1/1	530x325	40
16362-06	1/1	530x325	65



art.	GN	dim. mm.	h. mm.
16363-02	2/3	353x320	20
16363-04	2/3	353x320	40
16363-06	2/3	353x320	65



art.	GN	dim. mm.	h. mm.
16365-02	1/2	325x265	20
16365-04	1/2	325x265	40
16365-06	1/2	325x265	65



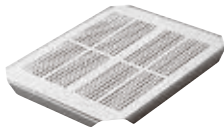

**Drainer plate**  
Falso fondo forato  
Abtropfplatte  
Plateau double fond perforé  
Fondo perforado

art.	GN
14402-00	1/1
14405-00	1/2
14407-00	1/3



**Adaptor bar**  
Separatore  
StegeAdapter/Zwischensteg  
Barrette de composition  
Adaptador

art.	GN	dim. mm.
14409-01	1/1	325
14409-02	2/1	530



**Pan, enamelled**  
Teglia smaltata  
Ofenblech, emalliert  
Bac émaillé  
Cubeta esmaltada

art.	GN	dim. mm.	h. mm.	lt.
44322-02	1/1	530x325	20	2,5
44322-04	1/1	530x325	40	5,0
44322-06	1/1	530x325	65	9,0

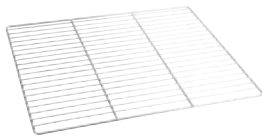

**Wire grid**  
Griglia in filo  
Gastronormrost  
Grille  
Rejilla

art.	GN	dim. mm.
44412-00	1/2	325x265
44423-00	2/3	353x320
44421-00	2/1	650x530



**Wire grid with edge**  
Griglia in filo con sponda  
Gastronormrost mit Seitenwand  
Grille avec arrêt  
Rejilla con borde

art.	GN	dim. mm.
44422-00	1/1	530x325

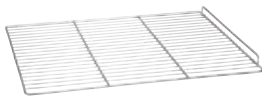

**Wire grid with edge**  
Griglia in filo con sponda  
Gastronormrost mit Seitenwand  
Grille avec arrêt  
Rejilla con borde

art.	GN	dim. mm.
44432-21	2/1	650x530



**Fry basket**  
Cesta per friggere  
Frittier-Korb  
Panier à frire  
Cesta escurrefrito

art.	GN	dim. mm.	h. mm.
11750-11	1/1	530x325	60



**Grid enamelled**  
Griglia smaltata  
Rost, emalliert  
Grille émaillé  
Rejilla esmaltada

art.	GN	dim. mm.
11760-11	1/1	530x325

# POLYCARBONATE POLICARBONATO

GN FOOD PANS  
CONTENITORI GN

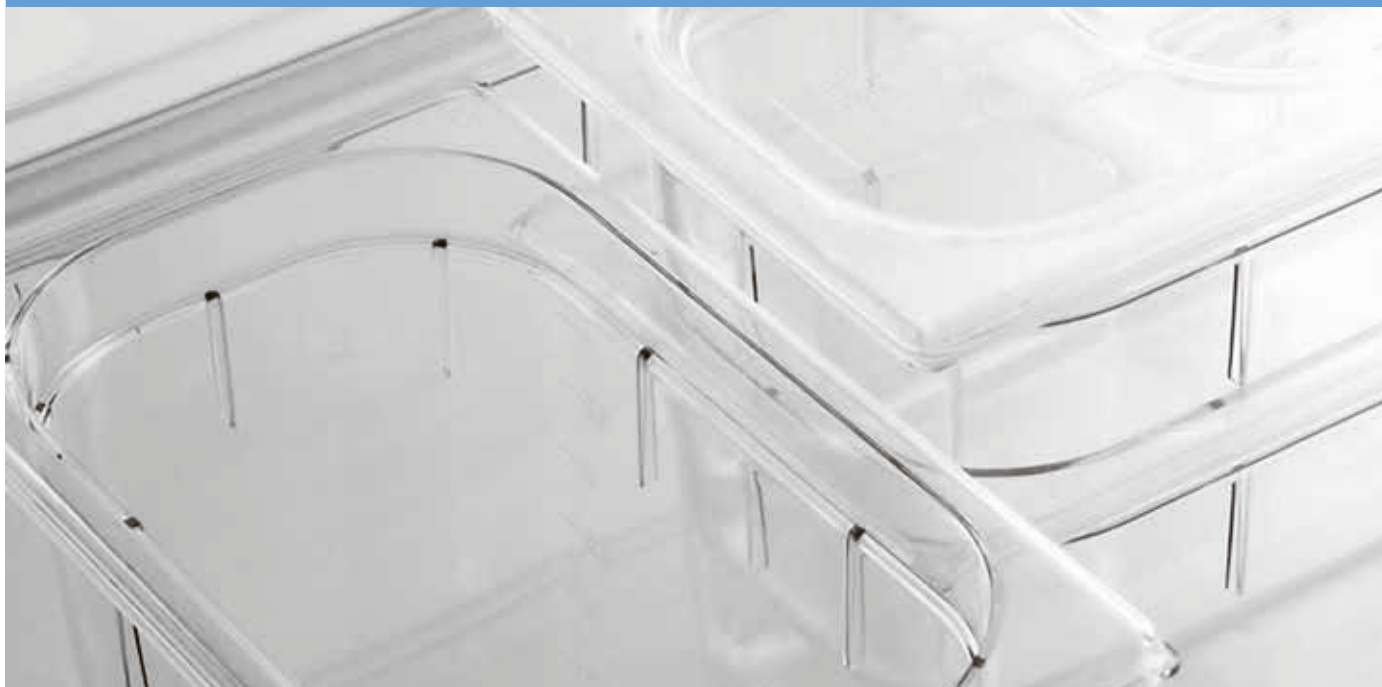

Withstands temperatures from **-40°C to +100°C**. With metric graduation. Stackable, ideal for storage, transportation and serving display.

Termoresistenti da **-40°C a +100°C**. Con scala graduata in litri. Impilabili, sono ideali per la conservazione, trasporto ed esposizione.

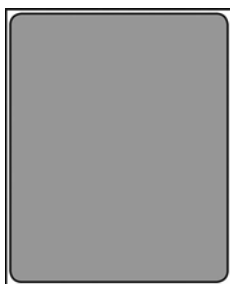

#### GN-containers

GN bacinelle  
GN-Behälter  
GN bacs  
GN cubetas

art.	GN	dim. mm.	h. mm.	lt.
14561-15	2/1	650x530	150	42
14561-20	2/1	650x530	200	52



art.	GN	dim. mm.	h. mm.	lt.
14562-06	1/1	530x325	65	8,5
14562-10	1/1	530x325	100	13,0
14562-15	1/1	530x325	150	19,5
14562-20	1/1	530x325	200	26,0



art.	GN	dim. mm.	h. mm.	lt.
14565-06	1/2	325x265	65	3,9
14565-10	1/2	325x265	100	5,9
14565-15	1/2	325x265	150	8,9
14565-20	1/2	325x265	200	11,8

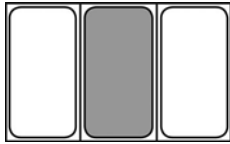

art.	GN	dim. mm.	h. mm.	lt.
14567-06	1/3	325x180	65	2,4
14567-10	1/3	325x180	100	3,6
14567-15	1/3	325x180	150	5,3
14567-20	1/3	325x180	200	7,0



art.	GN	dim. mm.	h. mm.	lt.
14568-06	1/4	265x160	65	1,7
14568-10	1/4	265x160	100	2,5
14568-15	1/4	265x160	150	3,7
14568-20	1/4	265x160	200	5,5



art.	GN	dim. mm.	h. mm.	lt.
14569-06	1/6	176x160	65	1,0
14569-10	1/6	176x160	100	1,5
14569-15	1/6	176x160	150	2,2
14569-20	1/6	176x160	200	3,4



art.	GN	dim. mm.	h. mm.	lt.
14570-06	1/9	176x110	65	0,6
14570-10	1/9	176x110	100	1,0



**GN-lid without handle**  
GN coperchio senza traversino  
GN-Deckel ohne Griff  
GN couvercle sans poignée  
GN tapa sin asa

art.	GN	dim. mm.
14571-00	2/1	650x530



**GN-lids with handle**  
GN coperchi con traversino  
GN-Deckel mit Griff  
GN couvercles avec poignée  
GN tapas con asa

art.	GN	dim. mm.
14572-00	1/1	530x325
14575-00	1/2	325x265
14577-00	1/3	325x180
14578-00	1/4	265x160
14579-00	1/6	176x160
14580-00	1/9	176x110



**GN-lid with silicone seal**  
GN coperchio con guarnizione silicone  
GN-Deckel mit Silikondichtung  
GN couvercle avec joint silicone  
GN tapa con junta de silicona

art.	GN	dim. mm.
14585-00	1/2	325x265



**Drainer plate**  
Falso fondo forato  
Abtropfplatte  
Plateau double fond perforé  
Fondo perforado

art.	GN	dim. mm.
14591-00	2/1	650x530
14592-00	1/1	530x325
14595-00	1/2	325x265
14597-00	1/3	325x180
14598-00	1/4	265x160
14599-00	1/6	176x160



# TRITAN BPA FREE

GN FOOD PANS  
CONTENITORI GN



**TRITAN - COPOLYMER - BPA FREE -40°C+90°C.**

Can be used in microwave ovens but not for prolonged times. The lids of the series 14800 polycarbonate and 14600 Tritan are interchangeable. Hermetic lids, NOT water-tight.

**TRITAN COPOLIMERO - BPA FREE -40°C+90°C.**

Utilizzabili nel microonde ma non per tempi prolungati. I coperchi della serie 14800 policarbonato e 14600 Tritan sono intercambiabili. Coperchi ermetici, NON a tenuta stagna.

## GN-containers

GN bacinelle  
GN-Behälter  
GN bacs  
GN cubetas

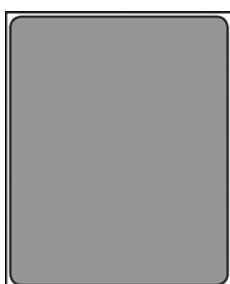

art.	GN	dim. mm.	h. mm.	lt.
14661-20	2/1	650x530	200	55,5



art.	GN	dim. mm.	h. mm.	lt.
14662-06	1/1	530x325	65	9,0
14662-10	1/1	530x325	100	13,3
14662-15	1/1	530x325	150	20,0
14662-20	1/1	530x325	200	26,4



art.	GN	dim. mm.	h. mm.	lt.
14665-06	1/2	325x265	65	4,0
14665-10	1/2	325x265	100	6,1
14665-15	1/2	325x265	150	9,0
14665-20	1/2	325x265	200	11,9

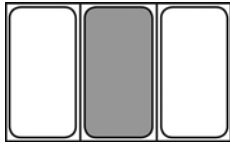

art.	GN	dim. mm.	h. mm.	lt.
14667-06	1/3	325x175	65	2,5
14667-10	1/3	325x175	100	3,8
14667-15	1/3	325x175	150	5,5
14667-20	1/3	325x175	200	7,1



art.	GN	dim. mm.	h. mm.	lt.
14668-06	1/4	264x162	65	1,7
14668-10	1/4	264x162	100	2,6
14668-15	1/4	264x162	150	3,8
14668-20	1/4	264x162	200	4,8



art.	GN	dim. mm.	h. mm.	lt.
14669-06	1/6	176x162	65	1,0
14669-10	1/6	176x162	100	1,6
14669-15	1/6	176x162	150	2,3
14669-20	1/6	176x162	200	2,8



art.	GN	dim. mm.	h. mm.	lt.
14670-06	1/9	176x108	65	0,6
14670-10	1/9	176x108	100	0,9



**GN-lids**  
GN-coperchi  
GN-Deckel  
GN couvercles  
GN tapas

art.	GN	dim. mm.
14671-00	2/1	650x530
14672-00	1/1	530x325
14675-00	1/2	325x265
14677-00	1/3	325x175
14678-00	1/4	264x162
14679-00	1/6	176x162
14680-00	1/9	176x108



**GN-lids, hermetic**  
GN coperchi ermetici  
GN-Deckel, hermetisch  
GN couvercles hermétiques  
GN tapas herméticas

art.	GN	dim. mm.
14682-00	1/1	530x325
14685-00	1/2	325x265
14687-00	1/3	325x175
14688-00	1/4	264x162
14689-00	1/6	176x162
14690-00	1/9	176x108



**Drainer plate**  
Falso fondo forato  
Abtropfplatte  
Plateau double fond perforé  
Fondo perforado

art.	GN	dim. mm.
14691-00	2/1	650x530
14692-00	1/1	530x325
14695-00	1/2	325x265

# POLYPROPYLENE POLIPROPILENE

GN FOOD PANS  
CONTENITORI GN



Transparent and stackable. Dish-washer safe. Do not use abrasive sponges and substances. Recommended for use from  $-40^{\circ}\text{C}$  to  $+70^{\circ}\text{C}$ . Graduation scale in liters. Lids tightly fitting.

Traslucide e impilabili. Lavabili in lavastoviglie con normali detersivi. Non utilizzare pagliette e sostanze abrasive. Consigliato l'utilizzo da  $-40^{\circ}\text{C}$  a  $+70^{\circ}\text{C}$ . Scala di graduazione in litri. Coperchio resistente per una perfetta chiusura stagna.



**GN-containers**

GN bacinelle  
GN-Behälter  
GN bacs  
GN cubetas

art.	GN	dim. mm.	h. mm.	lt.
14702-06	1/1	530x325	65	8,5
14702-10	1/1	530x325	100	13,0
14702-15	1/1	530x325	150	19,5
14702-20	1/1	530x325	200	26,0



art.	GN	dim. mm.	h. mm.	lt.
14705-06	1/2	325x265	65	3,9
14705-10	1/2	325x265	100	5,9
14705-15	1/2	325x265	150	8,9
14705-20	1/2	325x265	200	11,8

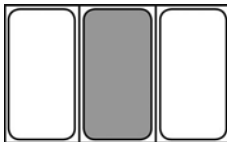

art.	GN	dim. mm.	h. mm.	lt.
14707-06	1/3	325x180	65	2,4
14707-10	1/3	325x180	100	3,6
14707-15	1/3	325x180	150	5,3
14707-20	1/3	325x180	200	7,0



art.	GN	dim. mm.	h. mm.	lt.
14708-06	1/4	265x160	65	1,7
14708-10	1/4	265x160	100	2,5
14708-15	1/4	265x160	150	3,7
14708-20	1/4	265x160	200	5,5



art.	GN	dim. mm.	h. mm.	lt.
14709-06	1/6	176x160	65	1,0
14709-10	1/6	176x160	100	1,5
14709-15	1/6	176x160	150	2,2
14709-20	1/6	176x160	200	3,4



art.	GN	dim. mm.	h. mm.	lt.
14710-06	1/9	176x110	65	1,3
14710-10	1/9	176x110	100	0,8



**Drainer plate**

Falso fondo forato  
Abtropfplatte  
Plateau double fond perforé  
Fondo perforado

art.	GN	dim. mm.	h. mm.
14712-00	1/1	471x266	16
14715-00	1/2	266x206	16
14717-00	1/3	266x117	16
14718-00	1/4	207x103	16
14719-00	1/6	117x103	16





**GN-lids**  
GN-coperchi  
GN-Deckel  
GN couvercles  
GN tapas

art.	GN	dim. mm.	col.
14722-00	1/1	530x325	●
14722-11	1/1	530x325	●
14722-22	1/1	530x325	●
14722-33	1/1	530x325	●
14722-99	1/1	530x325	○



art.	GN	dim. mm.	col.
14725-00	1/2	325x265	●
14725-11	1/2	325x265	●
14725-22	1/2	325x265	●
14725-33	1/2	325x265	●
14725-99	1/2	325x265	○



art.	GN	dim. mm.	col.
14727-00	1/3	325x180	●
14727-11	1/3	325x180	●
14727-22	1/3	325x180	●
14727-33	1/3	325x180	●
14727-99	1/3	325x180	○



art.	GN	dim. mm.	col.
14728-00	1/4	265x160	●
14728-11	1/4	265x160	●
14728-22	1/4	265x160	●
14728-33	1/4	265x160	●
14728-99	1/4	265x160	○



art.	GN	dim. mm.	col.
14729-00	1/6	176x160	●
14729-11	1/6	176x160	●
14729-22	1/6	176x160	●
14729-33	1/6	176x160	●
14729-99	1/6	176x160	○



art.	GN	dim. mm.	col.
14730-00	1/9	176x110	●
14730-11	1/9	176x110	●
14730-22	1/9	176x110	●
14730-33	1/9	176x110	●
14730-99	1/9	176x110	○

# IML POLYPROPYLENE POLIPROPILENE IML

GN FOOD PANS  
CONTENITORI GN



With permanent in molded label. To write on the label there is a specific marker that can be removed by simply washing in the dishwasher. Withstand temperatures from  $-40^{\circ}\text{C}$  to  $+80^{\circ}\text{C}$ . With both metric and American graduated scale. **WARNING:** polypropylene containers are not suitable for use on steam tables.

Con etichetta permanente costampata. Per scrivere sull'etichetta è disponibile un pennarello specifico che viene rimosso con il semplice lavaggio in lavastoviglie. Termoresistenti da  $-40^{\circ}\text{C}$  a  $+80^{\circ}\text{C}$ . Scala graduata sia secondo sistema metrico che americano. **AVVERTENZE:** i contenitori in polipropilene non sono indicati per l'uso su tavole a vapore.



**GN-containers**

GN bacinelle  
GN-Behälter  
GN bacs  
GN cubetas

art.	GN	dim. mm.	h. mm.	lt.
15101-06	1/1	530x325	65	9,0
15101-10	1/1	530x325	100	13,3
15101-15	1/1	530x325	150	20,0
15101-20	1/1	530x325	200	26,4



art.	GN	dim. mm.	h. mm.	lt.
15105-06	1/2	325x265	65	4,0
15105-10	1/2	325x265	100	6,1
15105-15	1/2	325x265	150	9,0
15105-20	1/2	325x265	200	11,9

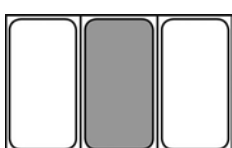

art.	GN	dim. mm.	h. mm.	lt.
15107-06	1/3	325x175	65	2,5
15107-10	1/3	325x175	100	3,8
15107-15	1/3	325x175	150	5,5
15107-20	1/3	325x175	200	7,1



art.	GN	dim. mm.	h. mm.	lt.
15108-06	1/4	264x162	65	1,7
15108-10	1/4	264x162	100	2,6
15108-15	1/4	264x162	150	3,8
15108-20	1/4	264x162	200	4,8



art.	GN	dim. mm.	h. mm.	lt.
15109-06	1/6	176x162	65	1,0
15109-10	1/6	176x162	100	1,6
15109-15	1/6	176x162	150	2,3
15109-20	1/6	176x162	200	2,8



art.	GN	dim. mm.	h. mm.	lt.
15110-06	1/9	176x108	65	0,6
15110-10	1/9	176x108	100	0,9



**Drainer plate**

Falso fondo forato  
Abtropfplatte  
Plateau double fond perforé  
Fondo perforado

art.	GN	dim. mm.
14912-00	1/1	530x325
14915-00	1/2	325x265



**GN hermetic lids with overmolded GASKET**

Coperchi GN ermetici con GUARNIZIONE sovrastampata  
GN hermetische Deckel mit umspritzter DICHTUNG  
Couvercles GN hermétiques avec JOINT surmoulé  
Tapas GN herméticas con JUNTA sobremoldeada

art.	GN	dim. mm.
14942-99	1/1	530x325
14945-99	1/2	325x265
14947-99	1/3	325x175



**GN-lids**  
GN coperchi  
GN-Deckel  
GN couvercles  
GN tapas

art.	GN	dim. mm.	col.
14922-00	1/1	530x325	●
14922-11	1/1	530x325	●
14922-22	1/1	530x325	●
14922-33	1/1	530x325	●
14922-77	1/1	530x325	●
14922-99	1/1	530x325	○



art.	GN	dim. mm.	col.
14925-00	1/2	325x265	●
14925-11	1/2	325x265	●
14925-22	1/2	325x265	●
14925-33	1/2	325x265	●
14925-77	1/2	325x265	●
14925-99	1/2	325x265	○



art.	GN	dim. mm.	col.
14927-00	1/3	325x175	●
14927-11	1/3	325x175	●
14927-22	1/3	325x175	●
14927-33	1/3	325x175	●
14927-77	1/3	325x175	●
14927-99	1/3	325x175	○



art.	GN	dim. mm.	col.
14928-00	1/4	264x162	●
14928-11	1/4	264x162	●
14928-22	1/4	264x162	●
14928-33	1/4	264x162	●
14928-77	1/4	264x162	●
14928-99	1/4	264x162	○



art.	GN	dim. mm.	col.
14929-00	1/6	176x162	●
14929-11	1/6	176x162	●
14929-22	1/6	176x162	●
14929-33	1/6	176x162	●
14929-77	1/6	176x162	●
14929-99	1/6	176x162	○



art.	GN	dim. mm.	col.
14930-00	1/9	176x108	●
14930-11	1/9	176x108	●
14930-22	1/9	176x108	●
14930-33	1/9	176x108	●
14930-77	1/9	176x108	●
14930-99	1/9	176x108	○





**Clips for lids**  
 Clips per coperchi  
 Clips für Deckel  
 Clips pour couvercles  
 Clips para tapas

art.	U. Pack	col.
15100-01	12	●
15100-02	12	●
15100-03	12	●
15100-04	12	●
15100-07	12	●



**Kit 2 markers**  
 Set 2 pennarelli  
 Satz 2 Marker  
 Set 2 marqueurs  
 Juego 2 marcadores

art.  
 15100-AA

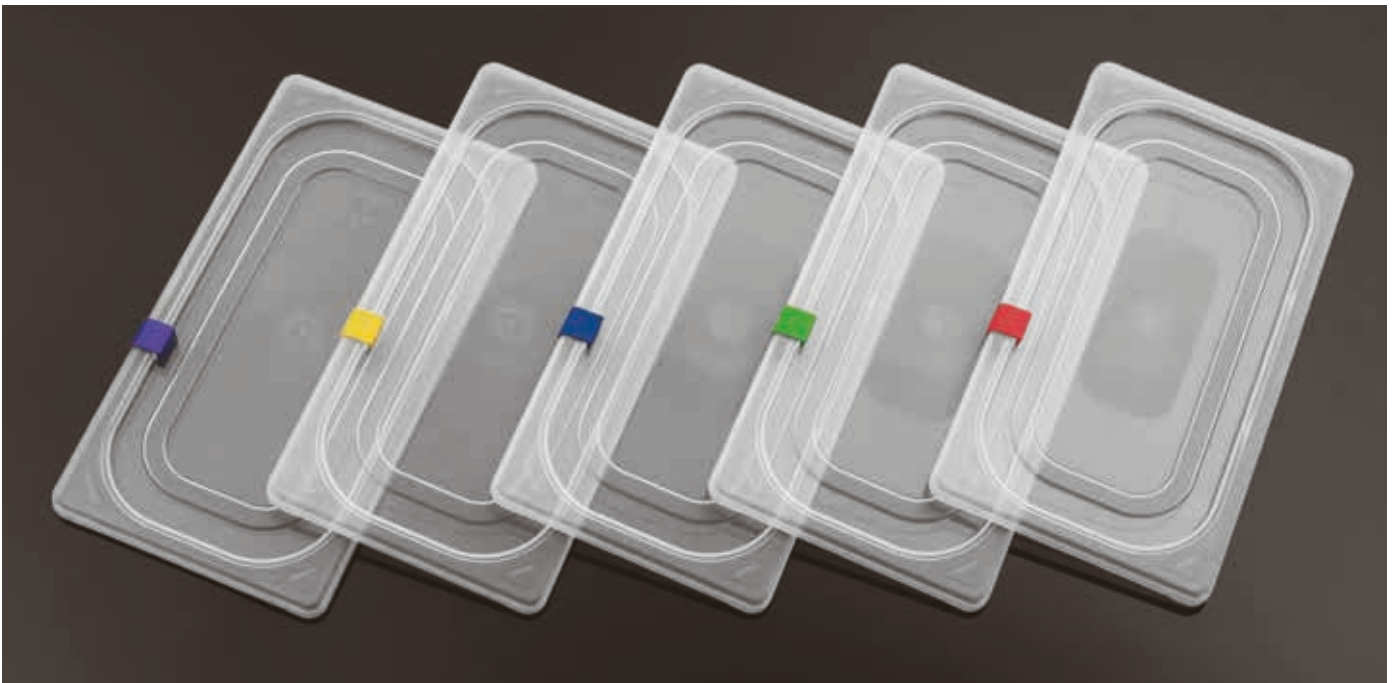



Melamine is suitable for hot and cold food use. Melamine is suitable for food storage at ambient or chilled temperatures for up to 24 hours. Melamine is not suitable for hot counters, displays, or heated cabinets. Do not expose melamine to direct flame or heat, including heat lamps and plate warmers. Temperature rating is between -20°C and 70°C (-4°F +158°F).

La melamina è adatta per l'uso sia con cibi caldi che freddi. La melamina è adatta per la conservazione degli alimenti a temperatura ambiente o refrigerata fino a 24 ore. La melamina non è adatta per piani caldi, espositori o armadi riscaldati. Non esporre a calore e fiamme dirette, incluse lampade alogene e scaldapiatti. Non esporre gli oggetti in melamina a temperature superiori a 70°C (-20°C +70°C).

GN-containers / Bacinelle / Behälter / Bacs / Cubetas



art.	GN	dim. mm.	h. mm.	lt.	col.
44877-11	1/1	530X325	65	7,1	○
44877B11	1/1	530X325	100	10,6	○
44878-11	1/1	530X325	65	7,1	●
44878B11	1/1	530X325	100	10,6	●



art.	GN	dim. mm.	h. mm.	lt.	col.
44877-24	2/4	160x530	65	3,0	○
44877B24	2/4	160x530	100	4,3	○
44878-24	2/4	160x530	65	3,0	●
44878B24	2/4	160x530	100	4,3	●



art.	GN	dim. mm.	h. mm.	lt.	col.
44877-12	1/2	325X265	65	3,4	○
44877B12	1/2	325X265	100	4,7	○
44878-12	1/2	325X265	65	3,4	●
44878B12	1/2	325X265	100	4,7	●

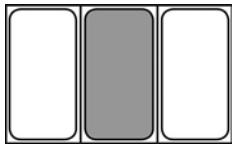

art.	GN	dim. mm.	h. mm.	lt.	col.
44877-13	1/3	325X175	65	2,0	○
44877B13	1/3	325X175	100	2,7	○
44878-13	1/3	325X175	65	2,0	●
44878B13	1/3	325X175	100	2,7	●



art.	GN	dim. mm.	h. mm.	lt.	col.
44877-14	1/4	265X160	65	1,4	○
44877B14	1/4	265X160	100	1,9	○
44878-14	1/4	265X160	65	1,4	●
44878B14	1/4	265X160	100	1,9	●



art.	GN	dim. mm.	h. mm.	lt.	col.
44877-16	1/6	175X160	65	0,8	○
44877B16	1/6	175X160	100	1,0	○
44878-16	1/6	175X160	65	0,8	●
44878B16	1/6	175X160	100	1,0	●



**GN-lids, POLICARBONATE**  
GN-coperchi, POLICARBONATO  
GN-Deckel, POLIKARBONAT  
GN couvercles, POLICARBONATE  
GN tapas, POLICARBONATO

art.	GN	dim. mm.
44818-11	1/1	530X325
44818-12	1/2	325X265
44818-13	1/3	325X175
44818-14	1/4	265X160
44818-16	1/6	175X160

PC



**Buffet ladder, chrome plated**  
Espositore buffet, cromato  
Büffet-Leiter, verchromt  
Escalier à buffet, chromé  
Escalera para buffet, cromada

art.	GN	dim. mm.
41403-01	1/3	31,5x32x48
41403-02	1/2	31,5x41,5x48
41403-03	1/2	31,5x56x66
41403-04	1/1	52x59x66

GN



# PORCELAIN PORCELLANA

GN FOOD PANS  
CONTENITORI GN



## GN-containers

GN bacinelle  
GN-Behälter  
GN bacs  
GN cubetas

art.	GN	dim. mm.	h. mm.	col.
44332-03	1/1	530x325	20	○
44332-06	1/1	530x325	65	○
44382A06	1/1	530x325	65	●
44382B06	1/1	530x325	65	●
44382G06	1/1	530x325	65	●
44382O06	1/1	530x325	65	●
44382Y06	1/1	530x325	65	●
44332B06	1/1	530x325	65	●



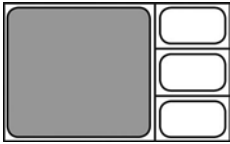

art.	GN	dim. mm.	h. mm.	col.
44333-03	2/3	353x320	20	○
44333-06	2/3	353x320	65	○
44333B06	2/3	353x320	65	●
44383O06	2/3	353x320	65	●
44383Y06	2/3	353x320	65	●

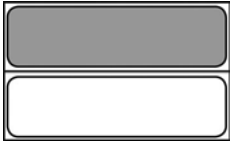

art.	GN	dim. mm.	h. mm.	col.
44334-03	2/4	162x530	20	○
44334-06	2/4	162x530	65	○
44384A06	2/4	162x530	65	●
44384O06	2/4	162x530	65	●
44384R06	2/4	162x530	65	●
44384Y06	2/4	162x530	65	●



art.	GN	dim. mm.	h. mm.	col.
44335-03	1/2	325x265	20	○
44335-06	1/2	325x265	65	○
44335B06	1/2	325x265	65	●
44385A06	1/2	325x265	65	●
44385B06	1/2	325x265	65	●
44385G06	1/2	325x265	65	●
44385O06	1/2	325x265	65	●
44385R06	1/2	325x265	65	●
44385Y06	1/2	325x265	65	●



art.	GN	dim. mm.	h. mm.	col.
44337-03	1/3	325x175	20	○
44337-06	1/3	325x175	65	○
44337B06	1/3	325x175	65	●
44387A06	1/3	325x175	65	●
44387B06	1/3	325x175	65	●
44387G06	1/3	325x175	65	●
44387O06	1/3	325x175	65	●
44387R06	1/3	325x175	65	●
44387Y06	1/3	325x175	65	●



art.	GN	dim. mm.	h. mm.	col.
44338-03	1/4	265x160	20	○
44338-06	1/4	265x160	65	○

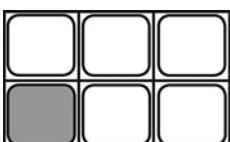

art.	GN	dim. mm.	h. mm.	col.
44339-03	1/6	176x160	20	○
44339-06	1/6	176x160	65	○

# INDUCTION PORCELAIN PORCELLANA INDUZIONE

GN FOOD PANS  
CONTENITORI GN

PR GN    INDUCTION  
READY!





**GN-containers**

GN bacinelle

GN-Behälter

GN bacs

GN cubetas

art.	GN	dim. mm.	h. mm.	col.
44342-06	1/1	530x325	65	○
44312A06	1/1	530x325	65	●
44312B06	1/1	530x325	65	●
44312G06	1/1	530x325	65	●
44312O06	1/1	530x325	65	●
44312R06	1/1	530x325	65	●
44312Y06	1/1	530x325	65	●



art.	GN	dim. mm.	h. mm.	col.
44343-06	2/3	353x320	65	○
44313B06	2/3	353x320	65	●
44313G06	2/3	353x320	65	●
44313O06	2/3	353x320	65	●
44313R06	2/3	353x320	65	●
44313Y06	2/3	353x320	65	●



art.	GN	dim. mm.	h. mm.	col.
44344-06	2/4	162x530	65	○
44314A06	2/4	162x530	65	●
44314B06	2/4	162x530	65	●
44314G06	2/4	162x530	65	●
44314O06	2/4	162x530	65	●
44314R06	2/4	162x530	65	●
44314Y06	2/4	162x530	65	●



art.	GN	dim. mm.	h. mm.	col.
44345-06	1/2	325x265	65	○
44315A06	1/2	325x265	65	●
44315B06	1/2	325x265	65	●
44315G06	1/2	325x265	65	●
44315O06	1/2	325x265	65	●
44315R06	1/2	325x265	65	●
44315Y06	1/2	325x265	65	●

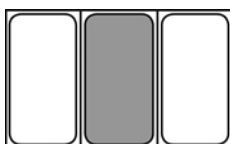

art.	GN	dim. mm.	h. mm.	col.
44347-06	1/3	325x175	65	○
44317A06	1/3	325x175	65	●
44317B06	1/3	325x175	65	●
44317G06	1/3	325x175	65	●
44317O06	1/3	325x175	65	●
44317R06	1/3	325x175	65	●
44317Y06	1/3	325x175	65	●



art.	GN	dim. mm.	h. mm.	col.
44346-06	1/4	265x160	65	○



# SERIES 12900

KITCHEN UTENSILS  
UTENSILI DA CUCINA

PA+  
plus



A wide range of professional kitchen utensils in composite material, polyamide (nylon 6.6) with fiberglass. Dishwasher safe, can be sterilized, heat resistant up to 220°C. Safe for non-stick cookware.

Un'ampia gamma di utensili professionali per la cucina in materiale composito, poliammide (nylon 6.6) con fibra di vetro. Lavabili in lavastoviglie, sterilizzabili, resistenti fino a 220°C. Ideali per l'uso con antiaderenti.





**PA+**  
plus

**Spoon**  
Cucchiaione  
Löffel  
Mouvette  
Cuchara

art.	l. cm.
12903-30	30
12903-40	38
12903-45	45



**PA+**  
plus

**Spatula**  
Spatola  
Teigschäber  
Spatule  
Espátula

art.	l. cm.
12905-25	25
12905-30	30
12905-35	35
12905-40	40
12905-45	45
12905-50	50



**PA+**  
plus

**Stirring ladle**  
Spatola per stemperare  
Rühr-u. Temperierlöffel  
Spatule à délayer  
Espátula para diluir

art.	l. cm.
12907-07	35
12907-08	35



**PA+**  
plus

**Spatula**  
Spatola  
Stielschäber  
Spatule  
Espátula

art.	l. cm.
12915-25	25
12915-26	28
12915-35	35
12915-45	45



**PA+**  
plus

**Spatula**  
Spatola  
Teigschäber  
Spatule  
Espátula

art.	l. cm.
12916-25	25
12916-33	33



**PA+**  
plus

**Spatula**  
Spatola triangolare  
Dreieck-Stielschäber  
Spatule trilon  
Espátula triangular

art.	l. cm.
12917-25	25



**PA+**  
plus

**Bevelled spatula**  
Spatola smussata  
Teigschäber  
Spatule plate biseautée  
Espátula blanda

art.	l. cm.
12906-35	35



**PA+**  
plus

**Spatula**  
Spatola  
Teigschäber  
Spatule  
Espátula

art.	l. cm.
12908-30	30
12908-35	35
12908-40	40



**PA+**  
plus

**Angular spatula**  
Paletta angolare  
Winkelpalette  
Spatule angulaire  
Espátula

art.	l. cm.
12909-12	12
12909-23	23



**PA+**  
plus

**Spatula, perforated**  
Paletta forata  
Teigschäber, perforiert  
Spatule ajourée  
Espátula perforada

art.	l. cm.
12921-01	30



**PA+**  
plus

**Spatula, perforated**  
Paletta forata  
Teigschäber, perforiert  
Spatule ajourée  
Espátula perforada

art.	l. cm.
12921-05	30



**PA+**  
plus

**Spatula**  
Paletta  
Teigschäber  
Spatule  
Espátula

art.	l. cm.
12921-10	32



**PA+**  
*plus*

**Fish & chips spatula**

Paletta fritti  
Fischheber  
Pelle à friture  
Espátula fritura

art.	l. cm.
12921-15	35



**PA+**  
*plus*

**Ladle**

Mestolo  
Schöpfplößel  
Louche  
Cacillo

art.	Ø cm.	l. cm.
12920-01	9	31



**PA+**  
*plus*

**Skimmer**

Schiumarola  
Schaumlöffel  
Ecumoire  
Espumadera

art.	Ø cm.	l. cm.
12920-05	11	35



**PA+**  
*plus*

**Spatula**

Paletta  
Teigschäber  
Spatule  
Espátula

art.	cm.	l. cm.
12920-10	9x10	35



**PA+**  
*plus*

**Fish & chips spatula**

Paletta fritti  
Fischheber  
Pelle à friture  
Espátula fritura

art.	cm.	l. cm.
12920-11	9x10	35



**PA+**  
*plus*

**Spoon**

Cucchiaione  
Giesslöffel  
Cuillère  
Cucharón

art.	l. cm.
12920-15	35



**PA+**  
*plus*

**Perforated spoon**

Cucchiaione forato  
Giesslöffel, perforiert  
Cuillère perforée  
Cucharón perforado

art.	l. cm.
12920-16	35



**PA+**  
*plus*

**Salad tongs**

Molla insalata  
Salatzange  
Pince à salade  
Pinza ensalada

art.	l. cm.
12930-51	25
12930-52	32



**PA+**  
*plus*

**Bread and pastry tongs**

Molla per pane e pasticceria  
Brot-/Gebäckzange  
Pince à pain et pâtisserie  
Pinza para pan y pasteleria

art.	l. cm.
12930-62	18
12930-63	23



**PA+**  
*plus*

**Serving tongs**

Molla tutto servire  
Servierzange  
Pince à servir  
Pinza servir

art.	l. cm.
12930-68	20
12930-69	25



**PA+**  
*plus*

**Spaghetti tongs**

Molla spaghetti  
Spaghettizange  
Pince à spaghetti  
Pinza espagueti

art.	l. cm.
12930-74	24



**PA+**  
*plus*

**Toast and pastry tongs**

Molla per toast e dolci  
Toast-/Gebäckzange  
Pince à toast et tarte  
Pinza para tostadas y dulces

art.	l. cm.
12930-77	21
12930-78	25



PA+  
plus

**Meat ball plier**  
Forbice per polpette  
Fleischkugelzange  
Pince à boulettes  
Pinza albóndigas

art.	l. cm.
12931-51	17



PA+  
plus

**Quenelle plier**  
Forbice per chenelle  
Quenellezange  
Pince à quenelles  
Pinza quenelles

art.	l. cm.
12931-53	19



PA+  
plus

**Perforated ladle**  
Mestolo forato  
Schöpföffel, gelocht  
Louche perforée  
Cacillo perforado

art.	Ø cm.	l. cm.
12967-06	6,5	30
12967-10	10,0	37,5



PA+  
plus

**Ladle**  
Mestolo  
Schöpföffel  
Louche  
Cacillo

art.	Ø cm.	l. cm.
12970-06*	6,5	30,0
12970-08	8,0	33,5
12970-10	10,0	37,5
12970-12	12,0	40,0

\*With spout. – Con becco.



PA+  
plus

**Pizza ladle, flat bottom**  
Mestolo pizza, fondo piatto  
Schöpföffel  
Louche  
Cacillo

art.	Ø cm.	l. cm.
12968-10	10	27



PA+  
plus

**Ladle, short handle**  
Mestolo, manico corto  
Schöpföffel mit kurzen Stiel  
Louche, manche court  
Cacillo, mango corto

art.	Ø cm.	l. cm.
12969-10	10	27



PA+  
plus

**Ladle, short handle**  
Mestolo, manico corto  
Schöpföffel mit kurzen Stiel  
Louche, manche court  
Cacillo, mango corto

art.	Ø cm.	l. cm.
12969-06	6,5	24



PA+  
plus

**Spoon**  
Cucchiaione  
Löffel  
Cuillère  
Cuchara

art.	l. cm.
12986-38	37,5



PA+  
plus

**Spoon, short handle**  
Cucchiaione, manico corto  
Löffel mit kurzen Stiel  
Cuillère, manche court  
Cuchara, mango corto

art.	l. cm.
12986-01	23



PA+  
plus

**Skimmer**  
Schiumarola  
Schaumlöffel  
Ecumoire  
Espumadera

art.	Ø cm.	l. cm.
12971-10	10	31
12971-12	12	37



PA+  
plus

**Spatula**  
Paletta liscia  
Backschaufel  
Spatule  
Espátula lisa

art.	cm.	l. cm.
12972-10	10	36,5
12972-12	12	38,0



PA+  
plus

**Perforated spatula**  
Paletta forata  
Backschaufel, perforiert  
Spatule perforée  
Espátula perforada

art.	cm.	l. cm.
12973-10	10	36,5
12973-12	12	38



PA+  
plus

**Conical colander**

Colatutto tronco conico  
Gemüsesieher  
Passoire à légumes  
Colador cónico

art.	Ø cm.	h.	lt.
12950-32	32	16	8
12950-40	40	20	12



SS  
PA+  
plus

**Strainer**

Colatutto  
Sieb  
Passoire  
Colador multiuso

art.	cm.	l. cm.
12932-22	22x18,5	44
12932-26	26x21	47



SS  
PA+  
plus

**Soup strainer**

Colino a rete  
Suppensieb  
Passe-bouillon  
Colador a red

art.	Ø cm.	l. cm.
12941-07	7	12
12941-10	10	12
12941-12	12	17
12941-14	14	17
12941-16	16	17
12941-18	18	17
12941-23	23	27
12941-26	26	27



SS  
PA+  
plus

**Wire whip, 8 silicone wires**

Frusta, 8 fili silicone  
Rührbesen, 8 Drähte aus Silikon  
Fouet, 8 fils en silicone  
Batidor, 8 varillas de siliconea

art.	l. cm.
12926-35	35



SS  
PA+  
plus

**Wire whip, 8 wires**

Frusta, 8 fili  
Rührbesen, 8 Drähte  
Fouet, 8 fils  
Batidor, 8 varillas

art.	l. cm.
12928-25	25
12928-30	30
12928-35	35
12928-40	40
12928-45	45
12928-50	50
12928-55	55
12928-60	60



SS  
PA+  
plus

**Egg whisk, 11 wires**

Frusta media, 11 fili  
Schneebeesen, 11 Drähte  
Fouet, 11 fils  
Batidor, 11 varillas

art.	l. cm.
12929-25	25
12929-30	30
12929-35	35
12929-40	40
12929-45	45



SS  
PA+  
plus

**Balloon whisk**

Frusta balloon  
Schneebeesen  
Fouet à blancs  
Batidor tipo globo

art.	l. cm.
12927-35	35
12927-45	45

**Water-tight, dishwasher safe.** – Perfetta tenuta stagna, lavabile in lavastoviglie.

**Water-tight, dishwasher safe.** – Perfetta tenuta stagna, lavabile in lavastoviglie.



# SERIES 48280 - 48278

KITCHEN UTENSILS  
UTENSILI DA CUCINA



**A wide range of professional kitchen utensils. These are essential tools to make original decorations as well as to ease the preparation of your recipes. All items are made of 18/10 stainless steel while their ergonomic handles are available both in stainless steel and Polypropylene. They are all hangable and can be cleaned in dishwasher. They boast a modern, functional design and are very easy to use.**

Un'ampia gamma di utensili professionali per la cucina, indispensabili per creare decorazioni originali e fantasiose, ma utili anche per svolgere le più semplici operazioni in modo preciso e veloce. Tutti i pezzi sono realizzati in acciaio inox 18/10, mentre la manichatura ergonomica è prevista nella versione acciaio inox o polipropilene. Tutti gli articoli sono dotati di un foro sul manico per essere appesi. Lavabili in lavastoviglie. Il design è moderno e funzionale per il massimo comfort d'utilizzo.



**Pizza chef knife**

Coltello pizzaiolo  
Messer für Pizzakoch  
Couteau à chef de pizza  
Cuchillo para chef de pizza

art.	l. cm.
48280-45	23,5



**Pizza wheel**

Rotella tagliapizza  
Pizzaschneider  
Roulette à pizza  
Ruedecilla cortapizzas

art.	Ø cm.	l. cm.
18324-10	10	24



**Pastry wheel**

Rotella tagliapasta  
Teigrädchen  
Roulette à pâte  
Ruedecilla para pasta

art.	Ø cm.	l. cm.
48280-32	4	18



**Double pastry wheel**

Rotella tagliapasta doppia  
Doppel-Teigrädchen  
Roulette à pâte double  
Ruedecilla para pasta doble

art.	Ø cm.	l. cm.
48280-39	4	18



**Vegetable knife**

Coltello verdure  
Gemüsemesser  
Couteau à légumes  
Cuchillo para verduras

art.	l. cm.
48280-48	19



**One-hand mincing knife**

Falcetta prezzemolo  
Einhandwiegemesser  
Hachinette persil  
Cuchillo para perejil

art.	Ø cm.	l. cm.
48280-20	11	17



**Parmesan cheese knife**

Coltello grana  
Parmesanmesser  
Couteau à Parmesan  
Cuchillo queso parmeso

art.	l. cm.
48280-04	20



**Oyster knife**

Coltello apriostriche  
Austernmesser  
Couteau à huîtres  
Cuchillo ostras

art.	l. cm.
48280-05	20,5



**Chestnut knife**

Coltello castagne  
Kastanienmesser  
Couteau à châtaignes  
Cuchillo castañas

art.	l. cm.
48280-21	16



**Fish scaler**

Squamapesce  
Fischentschupper  
Ecailleur  
Raspador de escamas

art.	l. cm.
48280-38	23,5



**Double fish scaler**

Squamapesce doppio  
Fischentschupper  
Ecailleur double  
Raspador de escamas doble

art. cm.

48280-37 22,5x3,5

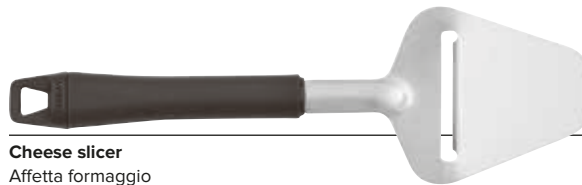

**Cheese slicer**

Affetta formaggio  
Käsehobel  
Coupe-fromage  
Cortador de queso

art. cm.

48280-41 25x7,6



**Cheese cleaver**

Mannaietta per formaggio  
Käsemesser  
Couperet à fromage  
Hachita para queso

art. cm.

48280-49 21x4

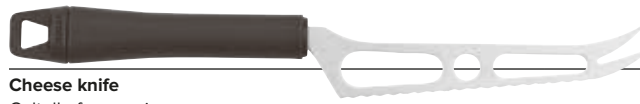

**Cheese knife**

Coltello formaggio  
Käsemesser  
Couteau à fromage  
Cuchillo para queso

art. l. cm.

48280-59 27



**Parmesan cheese knife**

Coltello parmigiano  
Parmesankäsemesser  
Couteau à Parmesan  
Cuchillo para queso parmesano

art. l. cm.

48280-46 24



**Butter spreader**

Spalmburro  
Butterstreicher  
Tartineur  
Cuchillo mantequilla

art. l. cm.

48280-75 21,5



**Vegetable sharpener**

Temperino per verdure  
Spiralschneider  
Taille crayon légumes  
Afilador para vegetales

art. Ø cm.

48280-12 4,5

48280-13 7,0



**Silicone basting brush**

Pennello in silicone  
Backpinsel, Silikon  
Pinceau, silicone  
Pincel pastelería, silicona

art. cm.

48280-09 25,5x4



**Basting brush**

Pennello  
Backpinsel  
Pinceau  
Pincel pastelería

art. cm.

48280-94 22,5x3,5



**Cheese grater**

Grattugia formaggio  
Käseraffel  
Râpe à fromage  
Rallador de queso

art. l. cm.

48280-06 24



**Bottle opener**

Levacapsule  
Flaschenöffner  
Décapsuleur  
Abrebotellas

art.	l. cm.
48280-02	19



**Can opener**

Apriscatole  
Flügeldosenöffner  
Ouvre-boîtes  
Abrelatas

art.	cm.
48280-03	22x4,6



**Melon baller**

Scavino  
Kugelausstecher  
Moule à pomme  
Vaciador

art.	Ø cm.	l. cm.
48280-24	1,0	19,0
48280-30	1,5	19,0
48280-31	2,0	19,0
48280-35	2,3	19,5
48280-36	3,0	19,5



**Double melon baller**

Scavino doppio  
Kugelausstecher, doppel  
Moule à pomme, double  
Vaciador doble

art.	Ø cm.	l. cm.
48286-67	2,2-3,0	17



**Oval melon baller**

Scavino ovale  
Kugelausstecher, oval  
Moule à pomme, ovale  
Vciador oval

art.	Ø cm.	l. cm.
48280-26	1,9	19,5



**Zucchini corer, dented**

Svuota zucchine  
Zucchini-Entkerner  
Vide-courgettes  
Vaciador de zucchini

art.	l. cm.
48280-54	24,5



**Pineapple coring tool**

Svuota ananas  
Ananasausstecher  
Vide-ananas  
Descorazonador de piña

art.	l. cm.
48280-10	25



**Asparagus peeler**

Pela asparagi  
Spargelschäler  
Éplucheur à asperges  
Pelador de espárragos

art.	l. cm.
48280-85	23,5





**Tomato peeler**

Pela pomodori  
Tomatenschäler  
Éplucheur à tomates  
Pelador de tomates

art. l. cm.

48280-08 18



**Y-shaped swivel peeler**

Sbucciatore a lama mobile  
Pendelschäler  
Éplucheur à lame pivotante  
Pelador oscilante

art. l. cm.

48280-53 18,5

48280-52 21,0



**Melon peeler**

Sbuccia melone  
Melonenschäler  
Éplucheur à melon  
Pelador de melon

art. Ø cm. l. cm.

48280-60 8,0 20

48280-61 9,0 21

48280-62 10,5 22

48280-63 12,0 23



**Potato peeler**

Pelapatate  
Kartoffelschäler  
Éplucheur  
Pelador de patatas

art. l. cm.

48280-34 19,5



**Orange peeler**

Pelorange  
Orangenschäler  
Éplucheur à orange  
Pelador de naranjas

art. l. cm.

48280-96 20



**Grapefruit knife**

Coltello per pompelmo  
Grapefruitmesser  
Couteau à pamplemousse  
Cuchillo para pomelo

art. l. cm.

48280-47 21,5



**Citrus bar knife**

Coltello bar  
Bar Messer  
Couteau bar  
Cuchillo bar

art. l. cm.

48280-97 23



**Fruit scoop**

Cucchiaio scavino frutta  
Fruchtlöffel  
Cuillère à évider pour fruits  
Cuchara ahueca frutas

art. l. cm.

48280-15 20



**Butter curler**

Arricciaburro  
Butterroller  
Coquilleur à beurre  
Rizador de mantequilla

art. l. cm.

48280-11 22,5



**Fruit decorator knife**

Coltello decora frutta  
Fruchtdekoriermesser  
Couteau denteleur  
Cuchillo para decorar fruta

art. l. cm.

48280-91 23



**Citrus stripper**  
Decoratore  
Ziseliermesser  
Canneleur  
Rallador de cítricos  
art. l. cm.  
48280-95 16,5



**Citrus zester stripper**  
Rigalimoni decoratore  
Zester Ziseliermesser  
Zesteur canneleur  
Acanalador rallador cítricos  
art. l. cm.  
48280-92 17



**Citrus zester**  
Rigalimoni  
Zester  
Zesteur  
Acanalador de cítricos  
art. l. cm.  
48280-90 17



**Apple corer**  
Levatorsoli  
Entkerner  
Vide-pomme  
Descorazonador  
art. Ø cm. l. cm.  
48280-25 1,2 21



**Wavy vegetable cutter**  
Tagliaverdure ondulato  
Wellenschneider  
Coupe-légumes ondulé  
Cortador de verduras ondulado  
art. l. cm.  
48280-23 11,5



**Coil whisk**  
Frusta a spirale  
Spiral Schneebesen  
Fouet à spirale  
Batidor espiral  
art. Ø cm. l. cm.  
48278-24 5 26,5



**Pizza wheel**  
Rotella tagliapizza  
Pizzaschneider  
Roulette à pizza  
Ruedecilla pizza  
art. Ø cm. l. cm.  
48278-33 7 21



**Pastry wheel**  
Rotella tagliapasta  
Teigrädchen  
Roulette à pâte  
Ruedecilla para pasta  
art. Ø cm. l. cm.  
48278-32 4 18



**Double pastry wheel**  
Rotella tagliapasta doppia  
Doppel-Teigrädchen  
Roulette a pâte double  
Ruedecilla para pasta doble  
art. Ø cm. l. cm.  
48278-39 4 18



**Fish scaler**  
Squamapesce  
Fischentschupper  
Ecailleur  
Quita escamas  
art. l. cm.  
48278-38 22



**Paring knife**

Spelucchino  
Spickmesser  
Couteau d'office  
Cuchillo mondador

art. l. cm.  
48278-55 22,5



**Conical colander**

Colino conico  
Spitzsieb  
Passoire chinois  
Colador cónico

art. Ø cm. l. cm.  
48278-13 16 35



**Strainer**

Colino  
Sieb  
Passoire  
Colador

art. Ø cm. l. cm.  
48278-12 8 27



**Vegetable knife**

Coltello verdure  
Gemüsemesser  
Couteau à légumes  
Cuchillo para verduras

art. l. cm.  
48278-48 19



**Soft cheese slicer**

Affetta formaggio tenero  
Weichkäsehobel  
Coupe-fromage à pâte molle  
Cortador de queso blando

art. cm.  
48278-42 20x7,5



**Cheese cleaver**

Mannaietta per formaggio  
Käsemesser  
Couperet à fromage  
Hachita para queso

art. cm.  
48278-49 21x4



**Parmesan cheese knife**

Coltello parmigiano  
Parmesankäsemesser  
Coutau à Parmesan  
Cuchillo queso parmenso

art. l. cm.  
48278-46 23,5



**Cheese slicer**

Affetta formaggio  
Käsehobel  
Coupe-fromage  
Cortador de queso

art. l. cm.  
48278-41 25





**Potato masher**

Pressapatate  
Kartoffelstampfer  
Presse-purée  
Prensador de patatas

art. cm. l. cm.  
48278-87 8x7 27



**Potato masher**

Pressapatate  
Kartoffelstampfer  
Presse-purée  
Prensador de patatas

art. cm.  
48278-31 27x8



**Butter spreader**

Spalmaburro  
Butterstreicher  
Tartineur  
Cuchillo mantequilla

art. l. cm.  
48278-75 21



**Grater**

Grattugia  
Raffel  
Râpe  
Rallador

art. cm.  
48278-20 25,5x5,5



**Grater**

Grattugia  
Raffel  
Râpe  
Rallador

art. cm.  
48278-21 25,5x5,5



**Oyster knife**

Coltello apriostriche  
Austernmesser  
Couteau à huîtres  
Cuchillo para ostras

art. l. cm.  
48278-45 20



**Straight icing spatula**

Spatola per glassa  
Glasurpalette  
Spatule glaçage plate  
Espátula pastelera

art. l. cm.  
48278-77 27,5



**Basting brush**

Pennello  
Backpinsel  
Pinceau cuisine  
Pincel pastelería

art. l. cm.  
48278-94 22



**Garlic press**

Spremiaglio  
Knoblauchpresse  
Presse-ail  
Prensador de ajo

art. cm.  
48278-37 19x5



**Jar opener**

Apribarattoli  
Einmachglasöffner  
Ouvre-bocal  
Abridor de tarros

art. cm.  
48278-01 25,5x8,5





**Bottle opener**

Levacapsule  
Flaschenöffner  
Ouvre-bouteille  
Abrebotellas

art. cm.  
48278-02 19x3,7



**Zucchini corer**

Svuota zucchine  
Zucchini-Entkerner  
Vide-courgettes  
Vaciador de zucchini

art. l. cm.  
48278-54 25



**Swivel peeler**

Sbucciatore a lama mobile  
Pendelschäler  
Éplucheur à lame pivotante  
Pelador oscilante

art. l. cm.  
48278-52 21



**Y-shaped swivel peeler**

Sbucciatore a Y  
Y-Pendelschäler  
Éplucheur  
Pelador Y

art. l. cm.  
48278-53 18,5



**Apple corer**

Levatoroli  
Apfelentkerner  
Vide-pomme  
Descorazonador de manzana

art. Ø cm. l. cm.  
48278-25 1,6 21,5



**Potato fork 3 prongs**

Forchettina patate 3 punte  
Pelkartoffelgabel 3 Zinken  
Fourchette à pommes de terre  
Tenedor tridente para patatas

art. l. cm.  
48278-17 16,5



**Can opener**

Apriscatole  
Flügeldosenöffner  
Ouvre-boîte  
Abrelatas

art. cm.  
48278-03 22x4,6



**Potato peeler**

Pelapatate  
Kartoffelschäler  
Éplucheur  
Pelador de patatas

art. l. cm.  
48278-34 19,5



**Melon baller**

Scavino  
Kugelausstecher  
Moule à pomme  
Vaciador

art. Ø cm. l. cm.  
48278-35 3 18



**Orange peeler**

Pelarance  
Orangenschäler  
Éplucheur à orange  
Pelador de naranja

art. l. cm.  
48278-96 20



**Grapefruit knife**

Coltello per pompelmo  
Grapefruitmesser  
Couteau à pamplemousse  
Cuchillo para pomelo

art. l. cm.  
48278-47 21,5



**Ice cream scoop**

Porzionatore gelato  
Eisportionierer  
Cuiillère à glace  
Porcionador para helado

art. Ø cm. l. cm.  
48278-95 4 21





**Coffee measuring spoon**

Dosacaffè  
Kaffeedosierlöffel  
Cuillère doaseuse à café  
Cuchara dosificador de café

art. Ø cm. l. cm.  
48278-16 3,5 20



**Fruit decorator knife**

Coltello decora frutta  
Fruchtdekoriermesser  
Couteau denteleur  
Cuchillo para decorar frutas

art. l. cm.  
48278-91 22,5



**Citrus zester stripper**

Rigalimoni decoratore  
Zester Ziseliermesser  
Zesteur canneleur  
Acanalador rallador cítricos

art. l. cm.  
48278-92 16,5



**Odor eliminator soap bar**

Saponetta toglì odori  
Geruch Entferner Seife  
Savonette enlève odeurs  
Jabón quita odores

art. cm.  
48278-99 7,5x5,5



**Soup ladle**

Mestolo  
Schöpflöffel  
Louche à soupe  
Cazo sopa

art. Ø cm. l. cm.  
48278-69 9 32  
48278-66 6 29



**Salad spoon**

Cucchiaio per insalata  
Salatlöffel  
Cuillère à salade  
Cucharón ensalada

art. Ø cm. l. cm.  
48278-62 5 25



**Egg separator**

Separauova  
Eiertrenner  
Séparateur d'oeuf  
Separador de huevos

art. Ø cm. l. cm.  
48278-36 5,5 20,5



**Cocktail spoon**

Cucchiaio cocktail  
Cocktailöffel  
Cuiller à cocktail  
Cuchara cóctel

art. Ø cm. l. cm.  
48278-15 6 28



**Butter curler**

Arricciaburro  
Butterroller  
Coquilleur à beurre  
Rizador de mantequilla

art. l. cm.  
48278-11 21,5



**Sauce ladle**

Mestolino salsa  
Saucenlöffel  
Louche à sauce  
Cacillo salsas

art. Ø cm. l. cm.  
48278-68 7 29



**Salad serving fork**

Forchetta servire insalata  
Salatserviergabel  
Fourchette à servir salade  
Tenedor servir ensalada

art. Ø cm. l. cm.  
48278-64 5 25,5



**Perforated spoon**

Cucchiaio forato  
Giesslöffel, perforiet  
Cuillère percée  
Cuchara perforada

art. cm.  
48278-61 34x6



**Slotted turner**

Paletta forata  
Küchenwender, perforiert  
Pelle ajourée  
Espátula perforada

art. cm.  
48278-71 34,5x8,5

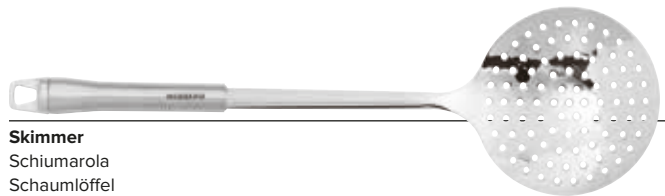

**Skimmer**

Schiumarola  
Schaumlöffel  
Ecumoire  
Espumadera

art. Ø cm. l. cm.  
48278-73 11 37

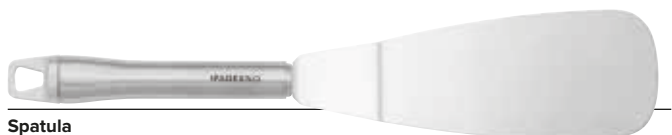

**Spatula**

Spatola  
Spachtel  
Spatule  
Espátula

art. cm.  
48278-76 28,5x5,6



**Cake server**

Pala torta  
Tortenheber  
Pelle à tarte  
Pala tarta

art. cm.  
48278-93 26x5,8

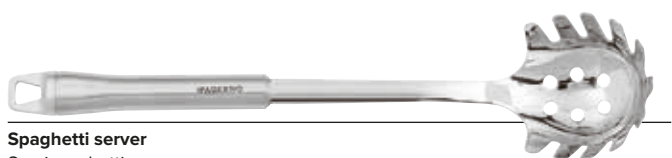

**Spaghetti server**

Servispaghetti  
Spaghettilöffel  
Cuillère à spaghetti  
Servidor para espagueti

art. Ø cm. l. cm.  
48278-74 7 30,5



**Meat fork**

Forchettone  
Fleischgabel  
Fourchette à viande  
Tenedor trinchar

art. l. cm.  
48278-65 32,5



**Rice spoon**

Cucchiaio risotto  
Reislöffel  
Cuillère de service à riz  
Cuchara arroz

art. l. cm.  
48278-63 27



**Spatula**

Spatola lasagne  
Lasagne Spatel  
Palette  
Espátula lasaña

art. cm.  
48278-27 29x4,5



**Skimmer**

Schiumarola  
Schaumlöffel  
Ecumoire  
Espumadera

art. Ø cm. l. cm.  
48278-88 11 36,5



**Soup ladle**

Mestolo  
Schöpflöffel  
Louche à soupe  
Cazo sopa

art. Ø cm. l. cm.  
48278-84 9,5 32,5





**Rice spoon**  
Cucchiaio riso  
Reislöffel  
Cuillère de service à riz  
Cuchara arroz

art. cm.  
48278-82 33x6,5



**Perforated spoon**  
Cucchiaio forato  
Gießlöffel, perforiert  
Cuillère percée  
Cuchara perforada

art. cm.  
48278-81 33x6,5



**Spaghetti server**  
Servispaghetti  
Spaghettillöffel  
Cuillère à spaghetti  
Servidor para espagueti

art. cm.  
48278-89 32x6,5



**Meat fork**  
Forchettone  
Fleischgabel  
Fourchette à viande  
Tenedor trinchar

art. l. cm.  
48278-83 32,5



**Silicone basting spoon**  
Cucchiaione in silicone  
Gießlöffel aus Silikon  
Cuillère de service en silicone  
Cuchara para servir de silicona

art. cm. l. cm.  
48278-14 5,5x8 26,5

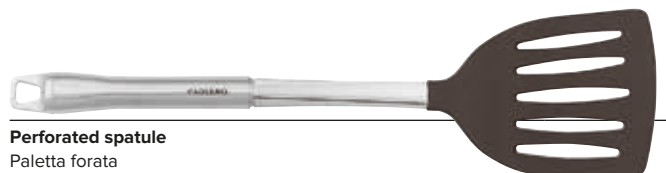

**Perforated spatula**  
Paletta forata  
Küchenwender, perforiert  
Pelle ajourée  
Pala perforada

art. cm.  
48278-85 33x8,5

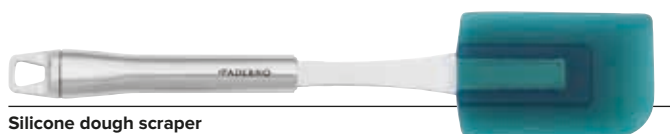

**Silicone dough scraper**  
Spatola in silicone  
Teigschaber aus Silikon  
Pelle en silicone  
Paleta de silicona

art. cm. l. cm.  
48278-28 5x9 28,5

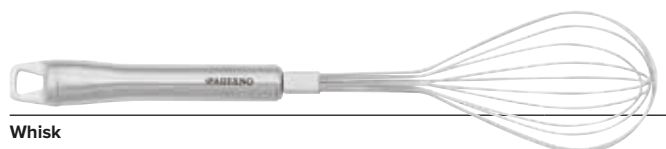

**Whisk**  
Frusta  
Schneebesen  
Fouet  
Batidor

art. l. cm.  
48278-18 24,5  
48278-19 29,5



# TURNERS SPATOLE

KITCHEN UTENSILS  
UTENSILI DA CUCINA

SS PP



Stainless steel turners with polypropylene handle.

Spatole in acciaio inox con manico in polipropilene.



**Pizza server**  
Spatola per pasticcio e pizza  
Pizzawender  
Pelle à pizza  
Espátula pizza

art. cm.  
18511-15 15,5x8,7



**Hamburger turner**  
Spatola hamburger  
Hamburgerspachtel  
Pelle à hamburger  
Espátula hamburguesa

art. cm.  
18512-15 19x13,8



**Lasagne spatula**  
Spatola lasagne  
Lasagneheber  
Pelle à lasagne  
Espátula lasaña

art. cm.  
18515-16 16,8x7,2



**Triangular spatula**  
Spatola triangolare  
Dreieckiger Spachtel  
Spatule triangulaire  
Espátula triangular

art.	cm.
18520-04	12x4
18520-06	12x6
18520-08	12x8
18520-10	12x10
18520-12	12x12



**Hamburger turner**  
Spatola hamburger  
Pfannenwender  
Grand palette à hamburger  
Espátula hamburguesa

art.	cm.
18516-24	24x7,2



**Perforated hamburger turner**  
Spatola hamburger, forata  
Pfannenwender, gelocht  
Grand palette perforée  
Espátula hamburguesa, perforada

art.	cm.
18517-24	24x7,2



**Perforated turner**  
Paletta forata  
Kuchenpalette, geschlitzt  
Palette perforée  
espátula perforada

art.	cm.
18510-07	13,5x7



**Slotted spatula**  
Spatola forata  
Pfannenpalette, geschlitzt  
Palette ajourée  
espátula perforada

art.	cm.
18509-01	16x7,5



**Slotted spatula**  
Spatola forata  
Pfannenwender, geschlitzt  
Palette ajourée  
espátula perforada

art.	cm.
18509-02	15,6x5



**Slotted spatula, flexible**  
Paletta forata, flessibile  
Pfannenwender, geschlitzt, flexibel  
Palette ajourée flexible  
espátula perforada flexible

art.	cm.
18509-03	15,6x8,7



**Bent icing spatula**  
Spatola cuoco con scalino  
Confiseriepalette  
Palette coudée  
Espátula pastelera acodada

art.	cm.
18518-22	22x3,4
18518-26	25x3,7
18518-30	30x4,3



**Straight icing spatula**  
Spatola cuoco  
Back- und Glasurpalette  
Spatule glaçage plate  
Espátula pastelera lisa

art.	cm.
18519-15	15,5x3
18519-22	22x3,4
18519-26	26x3,7
18519-30	31x4,3
18519-35	36x5



**Pie server**  
Paletta dolci  
Gebäckpalette  
Palette à gâteau  
Espátula pasteles

art.	cm.
18513-14	14,5x6,5



**Pie server serrated edge**  
Pala torta seghettata  
Kuchenschaukel gezackte Kante  
Pelle à gâteau côté dentelé  
Pala pasteles filo dentado

art.	cm.
18514-17	16,3x5,8



**Pie server serrated edge**  
Pala torta seghettata  
Kuchenschaukel gezackte Kante  
Pelle à gâteau côté dentelé  
Pala pasteles filo dentado

art.	cm.
18514-18	17,3x5,8

**Bent. – Con scalino.**

# LADLES MESTOLI

KITCHEN UTENSILS  
UTENSILI DA CUCINA



**The PADERNO ladle.**  
Handle-cup connection (one piece ladle). Thicker handle with rounded border.  
Diameter and capacity stamped on the handle.

**Il mestolo PADERNO.**  
Accoppiamento manico-coppa (mestolo unipezzo). Manico con spessore maggiorato con bordi arrotondati. Indicazione sul manico del diametro e della capacità.



**One piece ladle**  
Mestolo unipezzo  
Schöpflöffel, fugenlos  
Louche monobloc  
Cacillo monobloc

art.	Ø cm.	l. cm.	lt.
11970-06	6,5	30	0,07
11970-08	8,0	32	0,12
11970-09	9,0	33	0,20
11970-10	10,0	37	0,25
11970-11	11,0	38	0,33
11970-12	12,0	40	0,50
11970-14	14,0	44	0,75
11970-16	16,0	47	1,00



**Ladle, tube handle**  
Mestolo con manico a tubo  
Schöpflöffel mit Rohrstiel  
Louche avec manche tubulaire  
Cacillo con mango tubolar

art.	Ø cm.	l. cm.	lt.
11968-18	18	75	1,5
11968-20	20	75	2,0
11968-24	24	75	4,0



**One piece perforated ladle**  
Mestolo forato unipezzo  
Gelochter Schöpflöffel, fugenlos  
Louche monobloc perforée  
Cacillo monobloc perforado

art.	Ø cm.	l. cm.	lt.
11967-06	6,5	30	0,07
11967-08	8	32	0,12
11967-09	9	33	0,20
11967-10	10	37	0,25
11967-12	12	40	0,50
11967-14	14	44	0,75
11967-16	16	47	1,00



**Perforated ladle, tube handle**  
Mestolo forato con manico a tubo  
Schöpflöffel, gelocht mit Rohrstiel  
Louche perforée, manche tubulaire  
Cacillo perforado mango tubolar

art.	Ø cm.	l. cm.	lt.
11967-18	18	75	1,5
11967-20	20	75	2,0
11967-24	24	75	4,0



**One piece side basting spoon**  
Mestolo becco a versare unipezzo  
Saucenkelle quer, fugenlos  
Cuillère à arroser monobloc  
Cacillo monobloc para versar

art.	Ø cm.	l. cm.	lt.
11969-06	6,5	30	0,07
11969-37*	6,5	30	0,07

\*Left handed. – Per mancini.



**One piece basting spoon**  
Cucchiaione unipezzo  
Giesslöffel, fugenlos  
Cuillère monobloc  
Cucharón monobloc

art.	l. cm.
11982-38	38



**One piece perforated spoon**  
Cucchiaione forato unipezzo  
Giesslöffel perforiert, fugenlos  
Cuillère perforée monobloc  
Cucharón perforado monobloc

art.	l. cm.
11984-38	38



**One piece spoon, crosswise**  
Cucchiaione obliquo unipezzo  
Giesslöffel quer, fugenlos  
Cuillère oblique monobloc  
Cucharón obliquo monobloc

art.	l. cm.
11983-38	38
11983-37*	38

\*Left handed. – Per mancini.



**One piece meat fork, 3 prongs**  
Forchettone 3 denti unipezzo  
Fleischgabel 3 Zacken, fugenlos  
Fourchette 3 dents, monobloc  
Tenedor 3 dientes, monobloc

art.	l. cm.
11974-50	50
11974-70	70





NSF  
SS

**One piece meat fork, 2 prongs**  
Forchettone 2 denti unipezzo  
Fleischgabel 2 Zacken, fugenlos  
Fourchette 2 dents, monobloc  
Tenedor 2 dientes, monobloc

art.	l. cm.
11975-50	50
11975-99	100



NSF  
SS

**One piece spatula**  
Paletta liscia unipezzo  
Backschaufel, fugenlos  
Spatule monobloc  
Espátula lisa monobloc

art.	cm.	l. cm.
11972-10	10	36
11972-12	12	39



NSF  
SS

**One piece perforated spatula**  
Paletta forata unipezzo  
Backschaufel perforiert, fugenlos  
Spatule perforée monobloc  
Espátula perforada monobloc

art.	cm.	l. cm.
11973-10	10	36
11973-12	12	39



NSF  
SS

**Perforated slice**  
Pala a ridurre  
Reduzierspatel  
Spatule à réduire  
Espátula para reducir

art.	cm.	l. cm.
11976-50	12x15	50
11976-99	12x15	100



NSF  
SS

**One piece fish spatula**  
Paletta pesce unipezzo, forata  
Fischwender, fugenlos  
Pelle à poisson monobloc  
Pala pescado, monobloc

art.	cm.	l. cm.
11985-34	15x20	42



NSF  
SS

**One piece skimmer**  
Schiumarola unipezzo  
Schaumlöffel, fugenlos  
Ecumoire monobloc  
Espumadera monobloc

art.	Ø cm.	l. cm.
11971-08	8	29,0
11971-10	10	32,0
11971-12	12	35,0
11971-14	14	38,0
11971-16	16	41,0
11971-18	18	42,5
11971-20	20	44,5



NSF  
SS

**One piece skimmer, tube handle**  
Schiumarola unipezzo, manico a tubo  
Schaumlöffel, fugenlos, mit Rohrstiel  
Ecumoire monobloc, manche tubulaire  
Espumadera monobloc, mango tubolar

art.	Ø cm.	l. cm.
11971-25	25	75



NSF  
SS

**One piece ladle**  
Mestolo unipezzo  
Schöpföffel, fugenlos  
Louche monobloc  
Cacillo monobloc

art.	Ø cm.	l. cm.	lt.
11970-01	8	23	0,12

Short handle. – Manico corto.



NSF  
SS

**Side basting spoon**  
Mestolo con becco a versare  
Saucenkelle mit seitlichem Ausguß  
Cuillère à arroser  
Cacillo para versar

art.	Ø cm.	l. cm.	lt.
11969-02	6,5	23	0,07

Short handle. – Manico corto.



NSF  
SS

**One piece spoon**  
Cucchiaione unipezzo  
Giesslöffel, fugenlos  
Cuillère monobloc  
Cuchara monobloc

art.	l. cm.
11982-01	23,5

Short handle. – Manico corto.



NSF  
SS

**One piece meat fork**  
Forchettone unipezzo  
Fleischgabel, fugenlos  
Fourchette monobloc  
Tenedor monobloc

art.	l. cm.
11975-01	26

Short handle. – Manico corto.



NSF  
SS

**One piece perforated spatula**  
Paletta forata unipezzo  
Backschaufel perforiert, fugenlos  
Spatule perforée monobloc  
Espátula perforada monobloc

art.	cm.	l. cm.
11973-01	8x9,5	24

Short handle. – Manico corto.



NSF  
SS

**One piece skimmer**  
Schiumarola unipezzo  
Schaumlöffel, fügenlos  
Ecumoire monobloc  
Espumadera monobloc

art. Ø cm. l. cm.  
11971-01 9 26

**Short handle. – Manico corto.**



SS

**Ladle**  
Mestolo  
Schöpflöffel  
Louche  
Cacillo

art. Ø cm. l. cm. lt.  
41670-06 6 30 0,03  
41670-09 9 32 0,13



SS

**Skimmer**  
Schiumarola  
Schaumlöffel  
Ecumoire  
Espumadera

art. Ø cm. l. cm.  
41671-11 11 32



SS

**Slotted turner**  
Paletta forata  
Küchenwender, geschlitzt  
Pelle ajourée  
Espátula perforada

art. l. cm.  
41672-00 32



SS

**Spaghetti spoon**  
Cucchiaio per spaghetti  
Spaghettilöffel  
Cuillère à spaghetti  
Tenedor espaguetitis

art. l. cm.  
41673-00 32



SS

**Meat fork**  
Forchettone  
Fleischgabel  
Fourchette  
Tenedor

art. l. cm.  
41674-00 32



SS

**Basting spoon**  
Cucchiaione  
Giesslöffel  
Cuillère  
Cuchara

art. l. cm.  
41675-00 32



SS

**Perforated spoon**  
Cucchiaione forato  
Schöpfkelle, gelocht  
Cuillère percée  
Cuchara perforada

art. l. cm.  
41676-00 32



SS

**Sauce ladle**  
Cucchiaione salse  
Saucenkelle  
Cuillère à sauce  
Cuchara salsas

art. l. cm.  
41677-00 32



SS

**Whisk**  
Frusta  
Schneebesen  
Fouet  
Batidor

art. l. cm.  
41678-00 30



SS

**Wall rack**  
Asta  
Aufhängungstange  
Tringle de cuisine  
Asta para utensilios

art. l. cm.  
41670-AA 40  
41670-AB 60



SS

**Mesh skimmer**  
Schiumarola a rete stirata  
Schaumlöffel  
Ecumoire  
Espumadera

art. Ø cm. l. cm.  
11990-16 16 40



SS

**Mesh skimmer**  
Schiumarola a rete passabrodo  
Schaumlöffel  
Ecumoire  
Espumadera

art. Ø cm. l. cm.  
11991-16 16 40



SS

**Bird nest fryer**  
Colafritto  
Nestbacklöffel  
Nid à friture  
Molde nido

art. Ø cm. l. cm.  
42623-10 10 26



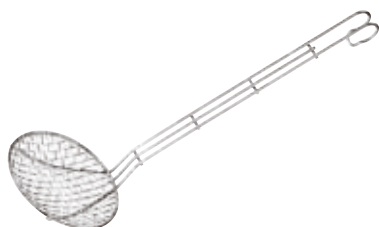

SS

**Wire skimmer**  
Schiumarola a filo  
Drahtlöffel  
Araignée  
Araña

art.	Ø cm.	l. cm.
12640-14	14	40
12640-16	16	40
12640-18	18	40
12640-20	20	50
12640-24	24	50
12640-28	28	50

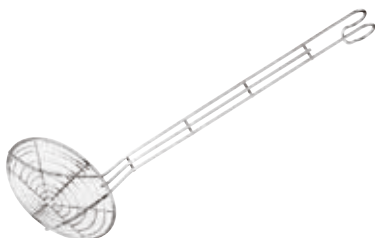

SS

**Wire skimmer**  
Schiumarola a filo  
Drahtlöffel  
Araignée  
Araña

art.	Ø cm.	l. cm.
12641-14	14	40
12641-16	16	40
12641-18	18	40
12641-20	20	50
12641-24	24	50
12641-28	28	50



SS

**Wire skimmer**  
Schiumarola a filo  
Drahtlöffel  
Araignée  
Araña

art.	Ø cm.	l. cm.
12642-28	28	85



SS

**French fry scoop**  
Pala per patate fritte  
Frittenschaufel  
Pelle à frites  
Pala chips

art.	cm.
41929-00	20x19x6,5



ABS

**French fry scoop**  
Pala per patate fritte  
Frittenschaufel  
Pelle à frites  
Pala chips

art.	cm.
41929-02	23x20x5

Ambidextrous. – Ambidestro.



W

**Spatula**  
Spatola  
Schäber  
Spatule  
Espátula

art.	l. cm.
42907-01	25
42907-02	30
42907-03	35
42907-04	40
42907-06	50
42907-07	60
42907-08	80
42907-09	100
42907-10	120



W

**Mixing spoon**  
Cucchiaione  
Löffel  
Cuillère  
Cuchara

art.	l. cm.
42901-20	20
42901-25	25
42901-30	30
42901-35	35
42901-40	40



W

**Spatula**  
Spatola  
Schäber  
Spatule  
Espátula

art.	l. cm.
42907-30	30
42907-35	35
42907-40	40



W

**Crepe spreader, 5 pcs**  
Spatole crêpes, 5 pz  
Crêpe-Paletten, 5 Stk  
Rateau à crêpes/raclettes, 5 pcs  
Espátula crêpes, 5 pz

art.	cm.
42900-15	18x18
42900-24	18x24

Beachwood. – Faggio.



SS

**Baster tube**  
Pompetta per sugo  
Soft-Spritze  
Pompe à jus  
Bomba para jugo

art.	l. cm.
42863-00	20



SS

PP

PS

**Marinating syringe, graduated**  
Siringa per marinata, graduata  
Marinierspritze, graduert  
Seringue à marinade, graduée  
Jeringa para marinar, graduada

art.	Ø cm.	l. cm.	ml.
42862-00	3,5	24	30



SS

**Fish-bone remover**  
Pinza toglie lische  
Grätenentkerner  
Pince à arêtes  
Pinza para espinas

art.	l. cm.
42592-01	12
42592-02	12

**01 thin bones, 02 thick bones.**  
01 lische fini, 02 lische grosse.



SS

**Cooking tongs**  
Pinza  
Kochzange  
Pince  
Pinza

art.	l. cm.
42904-01	16



SS

**Cooking tongs**  
Pinza  
Kochzange  
Pince  
Pinza

art.	l. cm.
42904-02	16



SS

**Cooking tongs**  
Pinza  
Kochzange  
Pince  
Pinza

art.	l. cm.
42904-03	15



SS

**Sausage tongs**  
Pinza per grill  
Grill-und Wurstzange  
Pince à saucisses  
Pinza para barbacoa

art.	l. cm.
41697-00	38



SS

**Cooking tongs**  
Pinza  
Kochzange  
Pince  
Pinza

art.	l. cm.
42902-31	30



SS

**Cooking tongs**  
Pinza  
Kochzange  
Pince  
Pinza

art.	l. cm.
42902-30	30



SS

**Grill tweezer**  
Molla per grill  
Grillzange  
Pince à grill  
Pinza para barbacoa

art.	l. cm.
41698-22	22,5
41698-30	30,0
41698-40	40,0



SS

**Serving tongs**  
Pinza a servire  
Servierzange  
Pince à servir  
Pinza para servir

art.	l. cm.
42854C25	25
42854C30	30



SS

**Serving tongs**  
Pinza a servire  
Servierzange  
Pince à servir  
Pinza para servir

art.	l. cm.
42854B25	25
42854B30	30





SS

**Serving tongs**  
Pinza a servire  
Servierzange  
Pince à servir  
Pinza para servir

art.	l. cm.
42854Y25	25
42854Y30	30



SS

**Serving tongs**  
Pinza a servire  
Servierzange  
Pince à servir  
Pinza para servir

art.	l. cm.
42854K25	25
42854K30	30



SS

**Serving tongs**  
Pinza a servire  
Servierzange  
Pince à servir  
Pinza para servir

art.	l. cm.
42854R25	25
42854R30	30



SS

**Serving tongs**  
Pinza a servire  
Servierzange  
Pince à servir  
Pinza para servir

art.	l. cm.
42854G25	25
42854G30	30



**Cooking tongs, silicone**  
Pinza, silicone  
Kochzange aus Silikon  
Pince en silicone  
Pinza de silicona

art.	l. cm.
42903-29	29



**Barbecue brush**  
Spazzola grill  
Grill-Bürste  
Brosse à grille  
Cepillo para barbacoa

art.	cm.	l. cm.
41773-00	5,5x11	27

Brass bristles. – Setole in ottone.



SS

**Whisk for basin**  
Frusta gigante  
Kesselbesen  
Fouet à bassine  
Batidor gigante

art.	l. cm.
41980-99	125



**Food-grade resin spatula**  
Spatola in resina alimentare  
Rührspaten für Speisenzubereitung  
Spatule en résine pour aliments  
Espátula de resina para alimentos

art.	cm.	l. cm.
44061-08	15,7x10,8	80
44061-09	23,5x10,8	90
44061-12	23,5x10,8	117
44061-14	23,5x10,8	137



SS

**Speed rack**  
Rastrelliera  
Flaschenregal  
Rack à bouteilles  
Rack de botellas

art.	cm.	h.	bot.
44060-50	56x10,5	15,5	6
44060-80	81x10,5	15,5	8



SS

**Bill spike**  
Spillone portascontrini  
Kassenscheine-Aufstecknadel  
Pique-addition  
Pincha papeles

art.	Ø cm.	h.
12504-20	9	20



W

**Bill spike**  
Spillone portascontrini  
Kassenscheine-Aufstecknadel  
Pique-addition  
Pincha papeles

art.	cm.	l. cm.
42504-09	9x5,5	10,5



SS

**Tickets-holder**  
Asta portascontrini  
Bons-/Zettelhalter  
Porte-fiches à billes  
Barra de notas

art.	l. cm.
42509-25	25
42509-50	50



SS

**Tab-grabber**  
Asta porta scontrini  
Bons-/Zettelhalter  
Porte-fiches  
Barra de notas

art.	l. cm.
42509-60	60
42509-99	100



SS

**Roll holder**  
Porta rotolo  
Rollenhalter  
Derouleur papier  
Portarollos

art.	l. cm.
42512-35	30



SS

**Wall film box**  
Supporto murale, porta pellicola  
Wand-Folien-Abreißgerät  
Dérouleur de film mural  
Soporte de pared para film

art.	l. cm.
42513-30	30
42513-45	45

**Roll max ø cm 13. – Rotolo ø max. cm 13.**



PP

**Additional plate stand**  
Anello distanziatore  
Gestell für Zusatzteller  
Support assiette supplémentaire  
Soporte distanciador

art.	Ø cm.	h.
47605-23	19-21	6



PP

**Plate cover**  
Copripiatto  
Tellerglocke  
Cloche  
Cubreplatos

art.	Ø cm.	h.
47603-25	25	6,5
47603-27	27	6,5
44998-31	31	6,5



PC

**Plate cover**  
Copripiatto  
Tellerglocke  
Cloche  
Cubreplatos

art.	Ø cm.	h.
44997-22	21	6,8
44997-24	23	6,8
44997-26	26	6,8
44997-28	28	6,8



NEW



SAN

**Plate cover**  
Copripiatto  
Tellerglocke  
Cloche  
Cubreplatos

art.	Ø cm.	h.	for/per Ø
44991-22	22,0	7,0	21,5
44991-24	24,0	7,5	22,5-23
44991-28	28,0	6,5	26-26,5
44991-29	28,5	6,5	27-27,5



SS

**Plate cover**  
Copripiatto  
Tellerglocke  
Cloche  
Cubreplatos

art.	Ø cm.	h.
41683-26	26,5	4,3



SS

**Funnel**  
 Imbuto  
 Trichter  
 Entonnoir  
 Embudo

art.	Ø cm.
42562-12	12
42562-14	14
42562-16	16
42562-18	18
42562-20	20
42562-25	25
42562-30	30



PP

**Funnel**  
 Imbuto  
 Trichter  
 Entonnoir  
 Embudo

art.	Ø cm.
47604-08	8
47604-10	10
47604-12	12
47604-15	15
47604-18	18
47604-20	20
47604-24	24
47604-30	30



PP

**Measuring jug**  
 Caraffa graduata  
 Messbecher  
 Pichet gradué  
 Jarra de medidas

art.	Ø cm.	h.	lt.
47608-02	19	12	2,2



PP

**Measuring jug**  
 Caraffa graduata  
 Messbecher  
 Pichet gradué  
 Jarra de medidas

art.	Ø cm.	h.	lt.
47606-02	8,5	10,0	0,25
47606-05	10,5	10,5	0,50
47606-10	12,5	14,5	1,00
47606-20	13,5	17,0	2,00
47606-30	15,5	21,0	3,00
47606-50	19,0	24,0	5,00



PP

**Measuring jug**  
 Caraffa graduata  
 Messbecher  
 Pichet gradué  
 Jarra de medidas

art.	Ø cm.	h.	lt.
47607-10	12,5	14,5	1
47607-20	13,5	17,0	2

**Lt. and ml. scale. Heat resistant up to 95°C.**  
 Scala in lt e ml. Resistente fino a 95°C.



SS

**Graduated measure jug**  
 Misurino graduato  
 Messbecher, graduert  
 Mesure graduée  
 Jarra de medidas

art.	Ø cm.	h.	lt.
42581-01	7,5	5	0,1
42581-03	10,0	7	0,3
42581-05	11,5	11	0,5
42581-10	15,0	13	1,0
42581-15	15,5	15	1,5
42581-20	17	19	2,0



SS

**Measuring spoons, 4 pcs**  
 Misurini set 4 pz  
 Messlöffel Set 4-tlg.  
 Cuillères à mesurer 4 pcs  
 Cucharas medidoras 4 pz

art.	ml.
42615-04	1-2,5-5-15



SS

**Measuring cups, 4 pcs**  
 Misurini set 4 pz  
 Messlöffel Set 4-tlg.  
 Cuillères à mesurer 4 pcs  
 Cucharas medidoras 4 pz

art.	ml.
42616-04	60-80-125-250



**SS**

**Lever dispenser**

Dosatore  
Hebeldosierspender  
Distributeur à manette  
Dispensador

art.	Ø cm.	h.
41528-21	21	22,5
41528-22	22	18,0

**Suitable for 5 kg bucket. – Per bidone da kg 5.**



**AY**

**Dispenser**

Dosatore  
Dosierspender  
Doseur  
Dispensador

art.	ml.
47609-02	250
47609-03	350
47609-09	950
47609-13	1350



**AY**

**Dispenser**

Dosatore  
Dosierspender  
Doseur  
Dispensador

art.	ml.
47609-04	375
47609-07	750
47609-12	1250
47609-16	1650



**PE**

**Squeeze bottle**

Flacone dosatore  
Quetschflasche  
Flacon doseur  
Frasco dosificador

art.	ml.	col.
41526-R1	240	●
41526-R2	360	●
41526-R3	720	●



**PE**

**Squeeze bottle**

Flacone dosatore  
Quetschflasche  
Flacon doseur  
Frasco dosificador

art.	ml.	col.
41526-B1	240	○
41526-B2	360	○
41526-B3	720	○



**PE**

**Squeeze bottle**

Flacone dosatore  
Quetschflasche  
Flacon doseur  
Frasco dosificador

art.	ml.	col.
41526-G1	240	●
41526-G2	360	●
41526-G3	720	●



**PE**

**Squeeze bottle, 4 pcs**

Flacone dosatore, 4 pz  
Quetschflasche, 4 Stk  
Flacon doseur, 4 pcs  
Frasco dosificador, 4 pz

art.	Ø cm.	h.	ml.
41526-01	3	8,5	30



**PE**

**Squeeze bottle, 4 pcs**

Flacone dosatore, 4 pz  
Quetschflasche, 4 Stk  
Flacon doseur, 4 pcs  
Frasco dosificador, 4 pz

art.	Ø cm.	h.	ml.
41526-02	3,5	9,5	50



**PE**

**Squeeze bottle**

Flacone dosatore  
Quetschflasche  
Flacon doseur  
Frasco dosificador

art.	Ø cm.	h.	ml.
41526-05	5,0	18	200
41526-06	5,5	19	350





PE

**Triple nozzle squeeze bottle**

Flacone dosatore, triplo ugello  
Quetschflasche mit Dreifachdüse  
Flacon doseur à trois becs  
Frasco dosificador 3 boquillas

art.	ml.	col.
41520-08	235	○
41520-12	355	○
41520-16	470	○
41520-24	700	○



SS

**Decorating spoons 2 pcs**

Cucchiari decorazione 2 pz  
Dekoration-Löffel 2 Stk  
Cuillères pour décorer 2 pcs  
Cucharas para decoración 2 pz

art.	l. cm.
47831-02	19-23



SS

**Flour scoop**

Sessola tonda  
Mehlschaufel  
Pelle à farine  
Librador

art.	lt.
42609-10	0,10
42609-15	0,40
42609-20	1,00
42609-23	1,70
42609-25	2,80



PP

**Flour scoop**

Sessola  
Mehlschaufel  
Pelle à farine  
Librador

art.	cm.	lt.
17610-01	20x7	0,10
17610-02	27,5x9,5	0,25
17610-05	32,5x12	0,50
17610-10	39x15	1,00



PA+  
plus

**Flour scoop**

Sessola  
Mehlschaufel  
Pelle à farine  
Librador

art.	cm.	lt.
12940-02	27,5x9,5	0,25
12940-05	32,5x12	0,50
12940-10	39x15	1,00
12940-20	48x18	2,00
12940-25	50x19,5	2,50



SS

**Bread sieve**

Setaccio pane  
Brotsieb  
Tamis à pain  
Cernidor para pan

art.	Ø cm.	h.
12604-22	22	8
12604-30	30	8
12604-34	34	8
12604-40	40	8

8 eye per inch. – 8 fori per 2,5 cm2.



SS

**Flour sieve**

Setaccio farina  
Mehlsieb  
Tamis à farine  
Cernidor para harina

art.	Ø cm.	h.
12605-22	22	8
12605-30	30	8
12605-34	34	8
12605-40	40	8

20 eye per inch. – 20 fori per 2,5 cm2.



SS

**Sieve**

Setaccio infarina pesce  
Sieb  
Tamis  
Cernidor

art.	Ø cm.	h.
12606-30	30	8
12606-34	34	8

4 eye per inch. – 4 fori per 2,5 cm2.



SS

**Sieve**

Setaccio rete pasticciare  
Sieb  
Tamis  
Cernidor

art.	Ø cm.	h.
12607-22	22	8
12607-30	30	8
12607-34	34	8

10 eye per inch. – 10 fori per 2,5 cm2.



SS

**Kitchenbowl, with handles**

Bacinella conica con maniglie  
Schüssel mit Griffen  
Bassine conique avec anses  
Caldero cónico con asas

art.	Ø cm.	h.	lt.
11955-32	32	16,0	8,8
11955-36	36	18,5	12,8
11955-40	40	20,0	17,0
11955-45	45	22,5	24,5
11955-50	50	24,0	32,5



SS

**Conical colander**

Colapasta tronco conico  
Gemüsesieher  
Passoire à légumes  
Colador cónico

art.	Ø cm.	h.	lt.
11930-24	24	12,0	3,5
11930-28	28	14,0	5,5
11930-32	32	16,0	8,8
11930-36	36	18,5	12,8
11930-40	40	20,0	17,0
11930-45	45	22,5	24,5
11930-50	50	24,0	32,5



SS

**Conical colander**

Colapasta tronco conico  
Gemüsesieher  
Passoire à légumes  
Colador cónico

art.	Ø cm.	h.	lt.
11927-24	24	12,0	3,5
11927-28	28	14,0	5,5
11927-32	32	16,0	8,8
11927-36	36	18,5	12,8
11927-40	40	20,0	17,0
11927-45	45	22,5	24,5
11927-50	50	24,0	32,5



SS

**Hemispherical mixing bowl**

Bacinella semisferica  
Schüssel  
Bassine demi-ronde  
Caldero semiesférico

art.	Ø cm.	lt.
11957-20	20	2,0
11957-25	25	3,7
11957-30	30	7,2
11957-35	35	10,5
11957-40	40	15,6



NSF

SS

**Kitchenbowl low**

Bacinella conica bassa  
Schüssel, flach  
Bassine  
Caldero cónico

art.	Ø cm.	h.	lt.
12582-13	13,2	6,0	0,5
12582-17	16,5	7,5	1,0
12582-22	22,0	7,5	2,0
12582-24	24,0	9,5	3,0
12582-32	30,5	11,5	6,0
12582-34	32,5	14,0	8,0
12582-38	38,0	13,5	11,0
12582-40	40,0	15,0	14,0



NSF

SS

**Kitchenbowl high**

Bacinella conica alta  
Tiefe Schüssel  
Bassine haute  
Caldero cónico alto

art.	Ø cm.	h.	lt.
12580-11	11,7	7,0	0,5
12580-17	15,5	9,0	1,0
12580-21	19,0	11,5	2,0
12580-24	22,0	12,0	3,0
12580-29	27,0	13,5	5,0
12580-30	29,0	15,0	6,0
12580-31	30,5	17,0	8,0
12580-36	35,5	18,5	11,0
12580-40	40,0	20,0	17,0
12580-45	45,0	22,0	25,0
12580-50	50,0	24,0	33,0



PA+  
plus

**Conical colander**

Colatutto tronco conico  
Gemüsesieher  
Passoire à légumes  
Colador cónico

art.	Ø cm.	h.	lt.
12950-32	32	16	8
12950-40	40	20	12



**Conical colander, aluminium**

Colapasta tronco conico, alluminio  
Gemüsesieher, Aluminium  
Passoire à légumes, alu  
Colador cónico, aluminio

art.	Ø cm.	h.	lt.
16927-32	32	16,0	8,8
16927-36	36	18,5	12,8
16927-40	40	20,0	17,0
16927-45	45	22,5	24,5
16927-50	50	24,0	32,5



SS

**Colander**

Colapasta con cerchio  
Gemüsesieher  
Passoire à légumes  
Colador con base

art.	Ø cm.	h.	lt.
11928-32	32	18,0	9,5
11928-36	36	19,0	12,0
11928-40	40	21,0	14,5



SS

**Strainer**

Colapasta semisferico  
Stielsieb  
Passoire hémispherique  
Colador semiesférico

art.	Ø cm.	h.	lt.
11926-22	22	12	2,7
11926-26	26	14	4,0



SS

**Strainer**

Colapasta  
Stielsieb  
Passoire  
Colador

art.	Ø cm.	h.	lt.
11924-18	18	11	2,8
11924-20	20	12	3,6
11924-22	22	13	5,0
11924-24	24	14	6,5
11924-28	28	15	9,3



**Strainer, aluminium**

Colapasta, alluminio  
Stielsieb, Aluminium  
Passoire, alu  
Colador, aluminio

art.	Ø cm.	h.	lt.
16924-20	20	11	3,2
16924-24	24	13	6,0
16924-28	28	15	9,3



PP

**Strainer**

Colapasta  
Stielsieb  
Passoire  
Colador

art.	Ø cm.
47610-22	22
47610-26	26
47610-30	30



PP

**Strainer**

Colapasta  
Stielsieb  
Passoire  
Colador

art.	Ø cm.
47610-18	18



PE

**Graduated bucket**

Secchio graduato  
Eimer mit Skala  
Seau gradué  
Cubo con medidas

art.	Ø cm.	h.	lt.
49889-09	27	26,2	9
49889-12	29	29,0	12
49889-15	31	30,8	15

With spout. – Con becco.



SS

**Graduated bucket**

Secchio graduato  
Eimer mit Skala  
Seau gradué  
Cubo con medidas

art.	Ø cm.	h.	lt.
41960-08	28,5	20,5	8
41960-10	30,0	25,0	10
41960-12	31,0	27,0	12
41960-15	32,5	31,0	15



SS

**Graduated bucket with bottom ring**

Secchio graduato con base  
Eimer mit Fuss u. Skala  
Seau gradué avec base  
Cubo con medidas y base

art.	Ø cm.	h.	lt.
41961-10	30,0	26,5	10
41961-12	31,0	28,5	12
41961-15	32,5	32,5	15



SS

**Lid for bucket**

Coperchio per secchio  
Deckel für Eimer  
Couvercle pour seau  
Tapa para cubo

art.	Ø cm.
41962-10	30,0
41962-12	31,0
41962-15	32,5



PP

**Mixing bowl**

Bacinella tonda  
Schüssel

Bassine ronde  
Caldero semiesférico

art.	Ø cm.	h.	lt.
47600-16	16	7,0	0,9
47600-20	20	8,5	1,6
47600-24	24	10,0	2,8
47600-28	28	11,0	4,5
47600-32	32	12,5	6,5
47600-36	36	14,0	10,0
47600-40	40	15,5	13,5



PP

**Mixing bowl**

Bacinella tonda  
Schüssel

Bassine ronde  
Caldero semiesférico

art.	Ø cm.	h.	lt.
47611-01	19,0	7,9	1,0
47611-03	24,0	11,5	2,5
47611-05	28,0	13,5	4,5
47611-06	32,5	14,7	6,0
47611-09	36,0	16,5	9,0
47611-13	40,0	18,5	13,0



PP

**Lid**

Coperchio  
Deckel

Couvercle  
Tapa

art.	Ø cm.
47611-11	19,0
47611-14	24,0
47611-15	28,0
47611-16	32,5
47611-19	36,0
47611-23	40,0



SS

**Mixing bowl**

Bastardella semisferica  
Schnees Schlagkessel

Bassine hémisphérique  
Caldero con asas

art.	Ø cm.	h.	lt.
11952-22	22	12,0	2,7
11952-26	26	14,0	4,0
11952-32	32	18,0	9,5
11952-36	36	20,5	14,0
11952-40	40	21,5	18,0



SS

**Mixing bowl without handles**

Bastardella senza maniglie

Schnees Schlagkessel ohne Griffe  
Bassine hémisphérique sans anses

Caldero sin asas

art.	Ø cm.	h.	lt.
11951-22	22	12,0	2,7
11951-26	26	14,0	4,0
11951-32	32	18,0	9,5
11951-36	36	20,5	14,0
11951-40	40	21,5	18,0



SS

**Foot for mixing bowl**

Base per bastardella

Fuss für Schnees Schlagkessel

Base pour bassine hémisphérique

Base para caldero

art.	Ø cm.	for/per Ø
11953-16	16	22-26
11953-22	22	32-36-40



SS

**Kettle for mixing machines**

Bacinella per planetaria  
Schlagmaschinenkessel

Bol pour mélangeurs  
Caldero para batidera

art.	Ø cm.	h.	lt.
11954-26	26	20,0	10,0
11954-30	30	25,0	16,0
11954-32	32	30,0	20,0
11954-36	36	28,5	25,0
11954-37	36	35,0	32,0
11954-40	40	35,5	40,0



SS

**Kitchen bowl with handle**

Tazzone con manico

Schlagschüssel mit Rohrstiel

Bol avec manche

Cazo bombeado

art.	Ø cm.	h.	lt.
41916-10	15	8,0	1,0
41916-15	17	9,0	1,2
41916-20	19	10,0	2,0



**Induction adapter**

Adattatore induzione

Induktion Adapterplatte

Disque relais pour induction

Adaptador para inducción

art.	Ø cm.
41922-16	16
41922-22	20

**Removable handle in heat resistant material.**  
Manico estraibile in materiale termo resistente.





**Manual salad spinner**

Centrifuga manuale per verdura  
Salatschleuder  
Essoreuse manuelle à salade  
Centrifugadora de ensalada

art.	Ø cm.	h.	lt.
49888-10	33	43	12
49888-20	43	52	25



SS

**Soup strainer**

Colino a rete  
Suppensieb  
Passe-bouillon  
Colador a red

art.	Ø cm.	l. cm.
12622-07	7	12
12622-10	10	12
12622-12	12	17
12622-14	14	17
12622-16	16	17
12622-18	18	17
12622-20	20	17
12622-23	23	27
12622-26	26	27



SS

**Strainer, double mesh**

Colapasta doppia rete  
Passiersieb, doppelnetz  
Passoire, maille double  
Colador doble red

art.	Ø cm.	l. cm.
12633-16	16	17
12633-18	18	17
12633-20	20	17
12633-23	23	27
12633-26	26	27



SS

**Strainer**

Colatutto  
Sieb  
Passoire  
Colador multiuso

art.	cm.	l. cm.
12630-22	22x18	19



SS

**Strainer**

Colino  
Sieb  
Passoire  
Colador

art.	Ø cm.
41570-10	8



SS

**Strainer, reinforced**

Colapasta rinforzato  
Grossküchensieb mit Verstärkung  
Passoire renforcé  
Colador reforzado

art.	Ø cm.	l. cm.
12635-23	23	27
12635-26	26	27
12635-30	30	44
12635-35	35	44



SS

**Vegetable sieve**

Passaverdura  
Passiergerät  
Mini hache-tout  
Pasa verdura

art.	Ø cm.
12638-20	20



SS

**Strainer**

Colatutto gigante  
Grossküchensieb  
Passoire géant  
Colador multiuso gigante

art.	Ø cm.	l. cm.
12636-32	32	60



SS

**Chinese colander**

Cornetto cinese  
Spitzsieb  
Passoire chinois  
Colador chino

art.	Ø cm.
41925-14	14
41925-16	16
41925-18	18
41925-20	20
41925-22	22
41925-24	24
41925-26	26



SS

**Chinese colander stand**

Supporto per cornetto cinese

Träger für Spitzsieb

Support chinois

Soporte para colador chino

art.	Ø cm.	h.
41933-18	18	28



SS

**Colander with wire gauze**

Cornetto cinese a rete

Gazensieb

Chinois à gaze

Colador chino a red

art.	Ø cm.
11929-20	20
11929-24	24



SS

**Chinese colander with wire protection**

Cornetto con protezione

Spitzsieb mit Verstärkung

Chinois à gaze avec renfort

Colador chino con protección

art.	Ø cm.
11932-20	20
11932-24	24



SS

**Chinese soup strainer**

Collino conico a rete

Suppen-Spitzsieb

Passe-bouillon chinois

Colador cónico a red

art.	Ø cm.
41931-08	8
41931-14	14
41931-16	16
41931-18	18



**Bouillon cloth**

Panno passabrodo

Bouillonstoffsieb

Etamine passe-bouillon

Paño para pasar caldo

art.	cm.	U. Pack
41932-05	87x70	5

**Twisted cotton cloth with seam.**

Tela di cotone ritorto, orlata.



ABS

**Rice scoop**

Porzionatore

Reis-Portionierer

Portionneur

Racionador

art.	h.	gr.
42653-04	4,5	120-130



PA+  
plus

**Portion rings set 6 pcs**

Anelli per impiattare set 6 pz

Portionierspeiseringe 6-tlg

Cercles portionneurs set 6 pcs

Anillos porcionadores 6 pz

art.	Ø cm.	h.
12943-13	3-12	3,5



PA+  
plus

**Portion rings set 6 pcs**

Anelli per impiattare set 6 pz

Portionierspeiseringe 6-tlg

Cercles portionneurs set 6 pcs

Anillos porcionadores 6 pz

art.	Ø cm.	h.
12944-13	3-12	3,5



PP

**Bag clip**

Clip chiudi sacco

Verschluss-Clip

Clip ferme sachet

Pinza cierra bolsas

art.	l. cm.	pcs/pz
42908-24	24	1

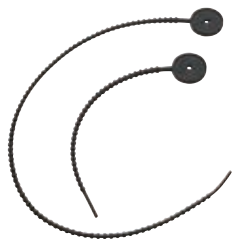

**Foodloops, silicone, 6 pcs**

Laccetti da cucina, silicone, 6 pz  
 Silikonbänder, 6 Stk  
 Lacets de cuisson, silicone, 6 pcs  
 Lazos de silicona de cocina, 6 pz

art.	l. cm.
41595B44	22
41595B45	53



**Presse canard, bronzo**

Presse canard, bronzo  
 Presse canard, Bronze  
 Presse à canard, bronze  
 Prensador para canard, bronco

art.	h.	Kg.
49845-01	52	16

Tinned. – Stagnato.



**Octopus-press**

Pressapolipo  
 Krake-Press  
 Presse à poulpe  
 Prensador para pulpo

art.	Ø cm.	h.
49760-00	10,5	20,5



**Mini-guitar**

Mini-chitarra  
 Mini-Guitare  
 Mini-guitare  
 Mini guitarra

art.	cm.	Kg.
49839-00	45x23x15	4,9

For products with tender and homogeneous consistency. Cut width 14,5 cm, thickness 5 mm.  
 Per prodotti teneri ma di consistenza omogenea. Larghezza taglio 14,5 cm, spessore 5 mm.

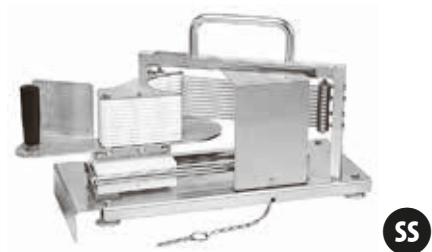

**Mozzarella/tomato cutter**

Affetta mozzarella/pomodori  
 Mozzarella-/Tomatenschneidergerät  
 Coupe-mozzarella/tomates  
 Cortador mozzarella/tomates

art.	cm.	Kg.
49820-05	48x20x32	7,1

Also suitable for cutting lemons, oranges or kiwis, etc. Slice thickness 5,5 mm.  
 Adatto anche per tagliare limoni, arance o kiwi, ecc. Spessore fetta 5,5 mm.





SS

**Tomato cutter**  
Affetta pomodori  
Tomatenschneidergerät  
Coupe-tomates  
Cortador tomates

art.	cm.	Kg.
49837-05	30x14x18	2

**Slice thickness 5,5 mm. – Spessore taglio 5,5 mm.**



SS

**Cube cutter**  
Taglia cubi  
Würfel-Schneidergerät  
Coupe-cubes  
Cortador en dados

art.	cm.	Kg.
49821-08	35,5x26x66	4

**Dice thickness 8 mm. – Spessore taglio 8 mm.**



SS

**Vegetable cutter**  
Taglia verdure  
Gemüseschneider  
Machine à tourner les légumes  
Cortador de verduras

art.	cm.	Kg.
49842-00	21x17,5x19	3,2

**To make chateau potatoes, cocottes and fondants lenght from 4 to 8 cm. 3 position adjustable blade. – Per patate chateau, cocotte e fondanti di lunghezza da 4 a 8 cm. Lama con 3 regolazioni. di taglio.**



SS

**Fruit cutter**  
Trancia spicchi  
Früchteschneider  
Coupe-fruits  
Cortador tomates

art.	cm.	Kg.
49838-08	38x26x58	3,3

**8 wedges, for vegetables and fruits without stone. – 8 spicchi, per ortaggi e frutta senza nocciolo.**



SS

**Apple corer/wedger set of blades**  
Set lame levatorsolo e trancia spicchi  
Apfelentkerner-/Schneidmesser  
Lames évideur/coupe-pommes  
Saca corazón y cortador para manzanas

art.
49838-98

**8 sections. – 8 sezioni.**



SS

**Pineapple-peeler/corer**  
Pela/svuota ananas  
Ananasschälmaschine  
Epluche-ananas  
Pelador de piña

art.	cm.	Kg.
49818-00	45x39x72	18

**Blade and pusher ø 89 mm.**  
Lama e pressatore ø 89 mm.



**Additional pushers and blades**  
Pressatori e lame opzionali  
Zusätzliche Presse und Messer  
Poussoirs et couteaux supplémentaires  
Empujador y cuchilla suplementarios

art.	des.	Ø cm.
49818-AC	blade/lama	7,4
49818-AD	pusher	7,4
49818-AE	blade/lama	10,2
49818-AF	pusher	10,2



SS

**Pineapple coring tool**  
Svuota ananas  
Ananasausstecher  
Vide ananas  
Saca corazón de piña

art.	Ø cm.	l. cm.
48280-10	2,5	24





SS

**Pinneapple slicer**

Taglia ananas  
Ananasteiler  
Coupe-ananas en rondelle  
Cortador de piña en rondajas

art.	Ø cm.	l. cm.
48218-00	2,5	24



**Electric peeler**

Pelatrice elettrica  
Elektr. Schälmaschine  
Eplucheur électrique  
Pelador eléctrico

art.	cm.	Kg.
49750-00	25x16x21,5	2



**Professional apple peeler**

Pela mele professionale  
Profi-Apfelschäler  
Pèle-pommes, professionnel  
Pelador de manzanas, profesional

art.	cm.	Kg.
49834-00	32x14x10	1,9



**Apple peeler with screw**

Pela mele con morsetto  
Apfelschäler, Tischklemme  
Pèle-pommes, socle serre-joint  
Pelador de manzanas, fijación brida

art.	cm.
49835-00	30x10x17



**Apple peeler, vacuum-power base**

Pela mele con ventosa  
Apfelschäler, Vakuum-Fuss  
Pèle-pommes, socle vacuum  
Pelador de manzanas, fijación ventosa

art.	cm.
49836-00	30x10x13



SS

**Apple corer/wedger**

Trancia spicchi per mela  
Apfelentkerner-/Schneider  
Lames évideur/coupe-pommes  
Cortador y descorazonador manzanas

art.	Ø cm.
48289-10	10



SS

**Egg wedger**

Taglia uova  
Eierteiler  
Tranche-oeufs  
Cortahuevos

art.	Ø cm.	l. cm.
42597-00	6,5	21



SS

**Egg knocker**

Apriuovo  
Eierköpfer  
Toque oeuf  
Abridor de huevos

art.	Ø cm.	l. cm.
42595-01	3,2	11



**Egg-slicer, aluminum**

Taglia uova, alluminio  
Eierteiler, Aluminium  
Tranche-oeufs rondelle, aluminium  
Cortahuevos guitarra, aluminio

art.	cm.
42588-01	13,5x8x4,5



**Egg-slicer duo**

Taglia uova doppio  
Eierteiler 2 in 1  
Tranche-oeufs 2 emplacements  
Cortahuevos doble

art.	cm.
42588-00	21x8x4,5



**Egg container**

Contentore per uova  
Eier-Behälter  
Porte-oeufs  
Contenedor para huevos

art. cm.  
47093-24 30x21,5x6,5



**AV**

**Egg container**

Contentore per uova  
Eier-Behälter  
Porte-oeufs  
Contenedor para huevos

art. cm.  
44947-07 15x20x5



**SS**

**Egg rings 2 pcs**

Anelli per uova 2 pz  
Eierringe, 2 Stk  
Ronds à oeufs, 2 pcs  
Anillos para huevos, 2 pz

art. Ø cm. h.  
42596-02 8 1,5



**Egg ring, non stick**

Anello per uova, antiaderente  
Eierring, beschichtet  
Rond à oeufs, anti-adhésif  
Anillo para huevos, antiadherente

art. Ø cm. h.  
42650-10 10 1,5



**Egg ring, non stick**

Anello per uova, antiaderente  
Eierring, beschichtet  
Rond à oeufs, anti-adhésif  
Anillo para huevos, antiadherente

art. Ø cm. h.  
42650-11 11 1,5



**Artichoke corer**

Svuota carciofi  
Artischocken Entkerner  
Etrogneur à artichauts  
Saca corazon para alcachofas

art. Ø cm. h.  
48288-02 8 8

**Top-rack dishwasher-safe. ABS body and scoop, PP cover, stainless steel blade.** – Lavabile in lavastoviglie nel cestello superiore. Corpo e paletta in ABS, coperchio in PP, lama inox.



**Brussel sprout cutter**

Taglia cavolini di Bruxelles  
Rosenkohl-Schneider  
Coupe-choux de Bruxelles  
Cortador de coles de Bruselas

art. cm.  
48288-03 8x8x10

**Dishwasher safe. SAN transparent body, ABS frame, PP base, stainless steel blade.** – Lavabile in lavastoviglie. Corpo trasparente SAN, telaio in ABS, base in PP, lama inox.



**SS**

**Mushroom cutter**

Taglia funghi  
Pilze-Teiler  
Tranche-champignons  
Cortador de hongos

art. Ø cm. l. cm.  
42598-00 7,6 20,7



**SS**

**Avocado peeler and slicer**

Pela/taglia avocado  
Avocadoschäler-/Teiler  
Pèle et tranche avocat  
Pelador y cortador de aguacete

art. l. cm.  
48286-62 18,5



**SS**

**Large vegetable slicer**

Pelaverdure  
Gemüseschäler  
Eplucheur à légumes  
Pelador de verduras

art. cm.  
48286-64 22x10



**Potato peeler**  
Pelapatate  
Sparschähler  
Eplucheur  
Pelador de patatas

art.	cm.
42589-00	5x4



**Potato ricer with 3 discs**  
Schiacciapatate, 3 griglie  
Kartoffelpresse, 3 Roste  
Presse-purée, 3 grilles  
Pasapurés, 3 discos

art.	Ø cm.	cm.
42566-03	8,5	30x10x11

**Discs/Dischi: ø 2,4 - 4,4 - 6,5 mm.**

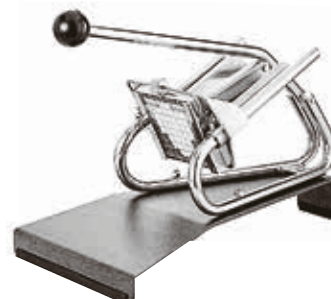

**French fry cutter**  
Taglia patate  
Kartoffelschneidgerät  
Coupe-frites  
Cortador de patatas fritas

art.	cm.	Kg.
49832-10	24x44x34	11

**Cutting knife/Quadro di taglio: 10 mm.**



**French fry cutter**  
Taglia patate  
Kartoffelschneidgerät  
Coupe-frites  
Cortador de patatas fritas

art.	cm.
49831-10	28x11x16,5

**Functional and solid. With suction base. Space-saving size. Accurate cutting 10 mm. Easy to clean.** – Funzionale e solido. Base con ventose. Salvaspazio. Taglio preciso, 10 mm. Facile da pulire.



**French fry cutter**  
Taglia patate  
Kartoffelschneidgerät  
Coupe-frites  
Cortador de patatas fritas

art.	cm.	Kg.
49832-02	26x9x12,5	1,2

**Cutting knives/Quadri di taglio: 9x9 - 12x12 mm.**



**Herb scissors, 5 blades**  
Forbice per erbe, 5 lame  
Kräuterschere, 5 Klängen  
Ciseaux à herbes, 5 lames  
Tijeras hierbas, 5 cuchillas

art.	l. cm.
18277-00	10



**Cheese rotary grater**  
Grattugia formaggio rotatoria  
Drehe-Käse-Raffel  
Frisette à fromage  
Ralladora giratoria para queso

art.	Ø cm.	h.
48281-22	22	17

**Oak wood base.** – Base legno di quercia.



**Rotary grater cover**  
Cloche per grattugia rotatoria  
Käse-Raffel-Haube  
Cloche à frisette  
Tapa para ralladora

art.	Ø cm.	h.
48281-23	15,5	11



**Tortillas wedger**  
Taglia tortillas  
Tortillasteiler  
Coupe-tortillas  
Corta tortillas

art.	Ø cm.
42599-06	25
42599-08	25

**Wedges/Spicchi: 6 - 8.**



**Grater, automatic**  
Grattugia automatica  
Reibe, automatisch  
Râpe automatique  
Rallador automático

art. cm.  
48295-10 20x5,4

**Hermetic container, removable, with lid, 2 blades.**  
**Ideal for cheese, nuts, chocolate, etc.**  
Recipiente hermético, removible, con cop., 2 lame.  
Ideale per formaggio, noci, cioccolato, ecc.



**Cheese wire cutter**  
Lira per formaggi  
Käse Drahtschneider  
Lyre à fromage  
Lira para quesos

art. cm.  
48282-21 20,5x26,7



**Garlic press, chromed**  
Spremiaglio, cromato  
Knoblauchpresse, verchromt  
Presse-ail, chromé  
Prensador de ajo, cromado

art. cm. l. cm.  
42565-00 3,5x2,5 14,5



**Olive seed remover, chromed**  
Snocciolatore, cromato  
Olivenentsteiner, verchromt  
Dénoyoteur, chromé  
Quita pepa/hueso, cromado

art. l. cm.  
42563-00 17



**Cherry core stripper**  
Snocciolatore  
Kirschenentsteiner  
Dénoyoteur de cerises  
Quita pepa/hueso

art. Ø cm. h.  
42563-44 10 34



**Mandoline**  
Mandolino  
Gemüseobel Mandoline  
Mandoline  
Mandolina

art. cm. Kg.  
49829-11 39x12,5x5,5 1,7

**Equipped with 7 interchangeable blades.**  
Dotato di 7 lame intercambiabili.







SS

**Slicer Mandoline, Grand Gourmet**

Mandolino Grand Gourmet  
Gemüsehobel Grand Gourmet  
Mandoline Grand Gourmet  
Mandolina Grand Gourmet

art.	cm.	Kg.
49830-60	40x12x28	1,6

**38 blades, 10 mm. – 38 lame, 10 mm.**



SS

**Mandoline**

Mandolino  
Gemüsehobel Mandoline  
Mandoline  
Mandolina

art.	cm.	Kg.
49755-10	38x11x3,5	1

**Non-slip base, ergonomic handle. Adjustable and precise cutting thickness. – Base antiscivolo, impugnatura ergonomica. Spessore di taglio regolabile e preciso.**

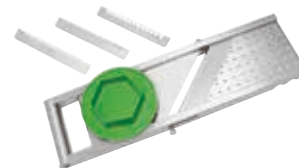

SS

**Mandoline**

Mandolino  
Gemüsehobel Mandoline  
Mandoline  
Mandolina

art.	cm.	Kg.
49752-00	33,5x11x2,3	0,6

**3 interchangeable blades of 2-3-6 mm. 3 lame intercambiabili da 2-3-6 mm.**



ABS

**Japanese Mandoline slicer**

Mandolino giapponese  
Japanese Gemüsehobel  
Mandoline japonaise  
Mandolina japonés

art.	cm.	Kg.
49753-06	11x31,5x3	0,3
49753-09	15x35x3,3	0,5

**1 plain blade and 3 blades of 1-2-3 mm. 1 lama liscia e 3 lame da 1-2-3 mm.**



SS

**Cutter/corer**

Intaglia verdure  
Ausstechforme  
Découpoir  
Sacabocados

art.	cm.
48286-70	3,7x8,5x9

**Cutting ø 3,4 cm. – Taglio ø 3,4 cm.**



ABS

SS

**Spiral vegetable slicer 3-blade**

Taglia verdure 3-lame  
Gemüeschneider 3-Messer  
Coupe légumes 3 lames  
Cortador de verduras 3 cuchillas

art.	cm.
49827-99	30x14x22

**3 interchangeable s/s blades (3 - 6 mm. and 1 straight blade for ribbon cuts). 3 lame inox intercambiabili (3 - 6 mm. e 1 lama dritta per taglio a nastro).**



ABS

SS

**Spiral vegetable slicer 7-blades 8-cuts**

Taglia verdure 7-lame 8-tagli  
Gemüeschneider 7-Messer 8-Schnitte  
Coupe légumes 7-lames 8-coupes  
Cortador de verduras 7-cuchillas 8-cortes

art.	cm.
49827-77	14,3x23,8x14,3

**Includes: 4 mm straight blade, 10 mm chipper blade, 1,5 mm wavy blade, 2,5 mm straight blade, 2 mm Angel hair blade, 3 mm shredder blade, 6 mm chipper blade. Top-rack dishwasher-safe. Include 2 lame lisce mm 2,5 e 4, lama ondulata da 1,5 mm, lama capelli d'angelo da 2 mm, 3 lame taglio spaghetti mm. 3, 6 e 10. Lavabile in lavastoviglie nel cestello superiore.**



SS

**Strip slicer**

Taglia verdure  
Gemüeschneider  
Coupe-lanières  
Cortador de verduras japonés

art.	cm.	Kg.
49823-00	20x20x25	1,9

**Width of cut 15 cm. Max vegetables length 11 cm. and ø 17 cm. – Larghezza taglio 15 cm. Lunghezza max verdura 11 cm. e ø 17 cm.**



ABS

**Strip slicer**

Taglia verdure  
Gemüseschneider  
Coupe lanière  
Cortador de verduras

art. cm.

49823-89 28x25x16,5

**Width of cut 13 cm. Thickness 0,5 mm.**  
Larghezza taglio 13 cm. Spessore 0,5 mm.



ABS

**Strip & spaghetti slicer**

Taglia verdure  
Gemüseschneider  
Coupe lanière et spaghetti  
Cortador de verduras japonés

art. cm.

49823-99 28x25x16,5

**Width of cut 13 cm. 2 blades 130x0,5 - 1x1,2 mm.**  
Larghezza taglio 13 cm. 2 lame 130x0,5 - 1x1,2 mm.



ABS

SS

**Vegetable cutter LE ROUET GOURMET**

Taglia verdure  
Gemüseschneider  
Coupe légumes  
Cortador de verduras

art. cm. Kg.

49827-03 13,5x36x24,3 2,4

**Cutting blocks 1-2-4 mm. Cutting thickness blade guirlandes 1>4 mm.**  
Spessore taglio lama guirlandes 1>4 mm.



SS

**Decoration tools 18 pcs**

Attrezzi decoro, 18 pz  
Dekoriersatz, 18-Tlg.  
Outils de décor 18 pcs  
Herramientas decoración 18 pz

art.

48286-03



SS

**Decoration tools 22 pcs**

Attrezzi decoro, 22 pezzi  
Dekoriersatz, 22-Tlg.  
Outils de décor 22 pcs  
Herramientas decoración 22 pz

art. cm.

48286-13 38,5x29



SS

**Thaï knife**

Stiletto thailandese  
Thaï-Messer  
Stylet thaï  
Cuchillo thaï

art. l. cm.

48286-08 16



**Ice knife**

Coltello ghiaccio  
Eis-Messer  
Couteau à glace  
Cuchillo para hielo

art.	l. cm.	gr.
47885-01	14+10,5	200



**Chisel V shape**

Scalpello ghiaccio a V  
Eismeissel  
Ciseau à glace  
Cinsel a V para hielo

art.	l. cm.	gr.
47885-02	31,5	200



**Chisel flat medium**

Scalpello ghiaccio 3 lati smussati  
Eismeissel  
Ciseau à glace  
Cinsel para hielo

art.	l. cm.	gr.
47885-03	50	600



**Chisel flat big**

Scalpello ghiaccio 1 lato smussato  
Eismeissel  
Ciseau à glace  
Cinsel para hielo

art.	l. cm.	gr.
47885-04	74,5	820



**Ice chisel set 4 pcs**

Scapelli ghiaccio 4 pz  
Eismeissel 4 Stk  
Ciseaux à glace 4 pcs  
Cinseles para hielo 4 piezas

art.	Kg.
47885-05	1,93



**Butter churn**

Mantecatore per burro  
Butterfaß  
Baratte à beurre  
Mantequera

art.	cm.	lt.
48294-01	11,5x11,5x40	1,6



**Butter mold**

Stampo per burro  
Butterform  
Moule à beurre  
Molde para mantequilla

art.	cm.	gr.
48294-02	12,2x6,6x4,3	80
48294-03	15,8x9x5	125



**Butter mold**

Stampo per burro  
Butterform  
Moule à beurre  
Molde para mantequilla

art.	cm.	gr.
48294-04	21x9,4x5,8	250



**Grater, non-slip handle**  
Grattugia, manico antiscivolo  
Reibe, Rutschfestes Griff  
Râpe queue antidérapant  
Rallador mango antiderrapante

art. cm. l. cm.  
42560-01 4x22 38,5

SS



**Grater, non-slip handle**  
Grattugia, manico antiscivolo  
Reibe, Rutschfestes Griff  
Râpe queue antidérapant  
Rallador mango antiderrapante

art. cm. l. cm.  
42560-02 4x22 38,5

SS



**Grater, non-slip handle**  
Grattugia, manico antiscivolo  
Reibe, Rutschfestes Griff  
Râpe queue antidérapant  
Rallador mango antiderrapante

art. cm. l. cm.  
42560-03 4x22 38,5

SS



**Grater, non-slip handle**  
Grattugia, manico antiscivolo  
Reibe, Rutschfestes Griff  
Râpe queue antidérapant  
Rallador mango antiderrapante

art. cm. l. cm.  
42560-04 7,7x13,3 30

SS



**Grater, non-slip handle**  
Grattugia, manico antiscivolo  
Reibe, Rutschfestes Griff  
Râpe queue antidérapant  
Rallador mango antiderrapante

art. cm. l. cm.  
42560-05 7,7x13,3 30

SS



**Grater, non-slip handle**  
Grattugia, manico antiscivolo  
Reibe, Rutschfestes Griff  
Râpe queue antidérapant  
Rallador mango antiderrapante

art. cm. l. cm.  
42560-06 7,7x13,3 30

SS



**Grater, non-slip handle**  
Grattugia, manico antiscivolo  
Reibe, Rutschfestes Griff  
Râpe queue antidérapant  
Rallador mango antiderrapante

art. cm. l. cm.  
42560-07 7,7x13,3 30

SS



**Grater, non-slip handle**  
Grattugia, manico antiscivolo  
Reibe, Rutschfestes Griff  
Râpe queue antidérapant  
Rallador mango antiderrapante

art. cm. l. cm.  
42560-08 7,7x13,3 30

SS



**Grater, non-slip handle**  
Grattugia, manico antiscivolo  
Reibe, Rutschfestes Griff  
Râpe queue antidérapant  
Rallador mango antiderrapante

art. cm. l. cm.  
42560-09 7,7x13,3 30

SS





SS

**Spatzle sieve**  
Grattugia per spatzle  
Spätzle-Reibe  
Grille à spatzle  
Rallador para spatzle

art. cm.  
49844-01 31x10,5x6



SS

**Nutmeg grater**  
Grattugia noce moscata  
Muskatreibe  
Râpe à muscade  
Rallador nuez moscada

art. cm.  
42556-00 4,5x14



SS

**4-ways grater**  
Grattugia 4 tagli  
Vierkantreibe  
Râpe 4 faces  
Rallador 4 caras

art. cm.  
42569-04 10x8x23



PP

**Dumplin maker**  
Stampo panzerotti  
Knödel-Form  
Moule à chaussons  
Molde para empanadillas

art. mm.  
49843-05 62, 82, 104, 177



**Safety can opener**  
Apriscatole sicuro  
Sicherheitsdosenöffner  
Ouvre-boîte de sûreté  
Abrelatas de seguridad

art. cm.  
48222-01 12,5x8



**Universal can opener**  
Apriscatole universale, nichelato  
Universal-Dosenöffner  
Ouvre-boîte, universel  
Abrelatas universal

art. cm.  
48220-00 8x7



**Can opener, PP handle**  
Apriscatole, impugnatura PP  
Dosenöffner, Griffe aus PP  
Ouvre-boîte, poignées PP  
Abrelatas, mango PP

art. l. cm.  
48280-03 21



SS

**Electric sieve**  
Passaverdura elettrico  
Elektropassiergerät  
Moulin électrique  
Molino eléctrico

art. Ø cm. h. kg./H Kg.  
49879-37 37 108 300 23,5

Equipped with 3 mm disc. – Griglia 3 mm.





**Sieve on tripod, tinned**

Passaverdura stagnato con supporto  
Passiergerät, verzinkt, mit Träger  
Moulin étamé sur pied  
Molino estañado sobre pie

art.	Ø cm.	h.	Kg.
42577-39	39	80	14

**Equipped with 3 mm disc. – Griglia 3 mm.**



**Tomato juicer sieve**

Passapomodoro professionale  
Profi-Tomatenpassiergerät  
Moulin à tomates professionnel  
Molino para tomates, profesional

art.	Ø cm.	h.
42576-00	21	50

**Equipped with 1 mm disc. – Griglia 1 mm.**



**Herb mill**

Macinaerbe  
Kräutermühle  
Moulin fines herbes  
Molino de hierbas finas

art.	cm.
42558-00	7x22

**SS**



**SS**

**Sieve, 3 discs**

Passaverdura, 3 griglie  
Passiergerät, 3 Roste  
Moulin inox, 3 grilles  
Molino inox, 3 rejillas

art.	Ø cm.	h.	Kg.
42571-20	19	16,5	0,46
42572-24	24	16,5	0,82

**Discs: 1,5 - 2 - 4 mm. – Griglie: 1,5 - 2 - 4 mm.**



**SS**

**Sieve, 3 discs**

Passaverdura, 3 griglie  
Passiergerät, 3 Roste  
Moulin inox, 3 grilles  
Molino inox, 3 rejillas

art.	Ø cm.	h.	Kg.
42570-32	31	25	1,4

**Discs: 1,5 - 2,5 - 4 mm. – Griglie: 1,5 - 2,5 - 4 mm.**



**Sieve, tinned, 3 discs**

Passaverdura stagnato, 3 griglie  
Passiergerät, verzinkt, 3 Roste  
Moulin étamé, 3 grilles  
Molino estañado, 3 rejillas

art.	Ø cm.	h.	Kg.
42573-31	31	25	1,4

**Discs: 1,5 - 2,5 - 4 mm. – Griglie: 1,5 - 2,5 - 4 mm.**



**SS**

**Sieve, 1 disc**

Passaverdura, 1 griglia  
Passiergerät, 1 Rost  
Moulin inox, 1 grille  
Molino inox, 1 rejilla

art.	Ø cm.	h.	Kg.
42574-37	37	32	3,5

**Equipped with 3 mm disc. – Griglia 3 mm.**



**Sieve, tinned, 1 disc**

Passaverdura stagnato, 1 griglia  
Passiergerät, verzinkt, 1 Rost  
Moulin étamé, 1 grille  
Molino estañado, 1 rejilla

art.	Ø cm.	h.	Kg.
42575-37	37	32	3,5

**Equipped with 3 mm disc. – Griglia 3 mm.**



42570 - 42573

42574 - 42575  
42577 - 49879



SS

**Bottles and cans press**

Pressa bottiglie e lattine  
Flaschen und Dosen Presse  
Presse bouteilles et boîtes  
Prensa botellas y latas

art. cm.  
49815-00 13,5x12x50

**To crush cans and plastic bottles. All cans. Bottles up to 2.5 l.** – Per tutti i tipi di lattine e per bottiglie di plastica fino a 2,5 l.



SS

**Table top can opener**

Apriscatole da banco  
Tisch-Dosenöffner  
Ouvre-boîte  
Abrelatas

art. cm. Kg.  
49867-01 28x12,2x77,5 5

**With screw base. Patented opening system. Opens round cans any sizes securely from 8 to 50 cm height), leaves smooth and not sharp edges. The cap can be reused. Dishwasher safe.** Base da avvitare. Sistema di apertura brevettato. Per scatole rotonde di tutte le dimensioni (h da 8 a 50 cm). Rifilo netto dei bordi esterni. Nessun rischio di taglio. Possibilità di riutilizzare il coperchio dalla scatola. Lavabile in lavastoviglie.



SS

**Table top can opener**

Apriscatole da banco  
Tisch-Dosenöffner  
Ouvre-boîte  
Abrelatas

art. cm. Kg.  
49867-02 28x12,2x77,5 5

**With clamp base. Patented opening system. Opens round cans any sizes securely from 8 to 50 cm height), leaves smooth and not sharp edges. The cap can be reused. Dishwasher safe.** Base con morsetto. Sistema di apertura brevettato. Per scatole rotonde di tutte le dimensioni (h da 8 a 50 cm). Rifilo netto dei bordi esterni. Nessun rischio di taglio. Possibilità di riutilizzare il coperchio dalla scatola. Lavabile in lavastoviglie.



**Table top can opener**

Apriscatole da banco  
Tisch-Dosenöffner  
Ouvre-boîte  
Abrelatas

art. l. cm.  
19810-00 56

**Can size up to height 45 cm. Clamp base and bar in die-cast aluminum, steel head. Table fixing either with screws or clamp.** – Altezza scatola fino a 45 cm. Corpo in alluminio pressofuso, testa in acciaio, fissaggio a viti o morsetto.



**Table top can opener, steel**

Apriscatole da banco, acciaio  
Tisch-Dosenöffner, Stahl  
Ouvre-boîte, acier  
Abrelatas, acero

art. l. cm.  
49811-00 40

**Can size up to height 30 cm. Table fixing with clamp base.** – Altezza scatola fino a 30 cm. Fissaggio a morsetto.



SS

**Table top can opener**

Apriscatole da banco  
Tisch-Dosenöffner  
Ouvre-boîte  
Abrelatas

art. l. cm.  
49812-00 55

**Can size up to height 40 cm. Table fixing with clamp base.** – Altezza scatola fino a 40 cm. Fissaggio a morsetto.



SS

**Electric can opener**

Apriscatole elettrico  
Elektrodosenöffner  
Ouvre-boîte électrique  
Abrelatas eléctrico

art. cm. Kg.  
49814-00 44x25x75 13

**Dual speed motor. Opens all can shapes from 50 to 270 mm height.** – Motore a 2 velocità. Per tutti i formati di scatola da 50 a 270 mm di altezza.

# THERMOMETERS TERMOMETRI

KITCHEN UTENSILS  
UTENSILI DA CUCINA







SS

**Meat roasting thermometer**

Termometro arrosti  
Braten-Thermometer  
Thermomètre à rôtir  
Termómetro asado

art. Ø cm. scala range  
49705-00 4,5 1°C 0+120°C

Penetration probe 13 cm. – Sonda l. 13 cm.



SS

**Meat roasting thermometer**

Termometro arrosti  
Braten-Thermometer  
Thermomètre à rôtir  
Termómetro asado

art. Ø cm. range  
19705-00 5 +54+88°C



SS

**Cooking & frying thermometer**

Termometro fritti  
Back-Thermometer  
Thermomètre à friture  
Termómetro frituras

art. Ø cm. scala range  
19706-00 5 10°C +38+205°C

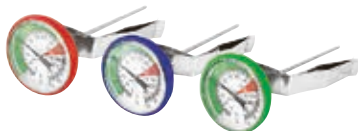

SS

**Milk frothing thermometers, 3 pcs**

Termometri latte/barista, 3 pz  
Mich-Thermometer, 3 Stk  
Thermomètres à lait, 3 pièces  
Termómetros leche, 3 pz

art. Ø cm. scala range  
49709-03 4,5 1°C -10+110°C

Red, green and blue, to easily identify different types of milk used, to avoid cross-contamination.

Stem 175 mm. – Rosso, verde e blu, per identificare facilmente i diversi tipi di latte utilizzati, per evitare la contaminazione incrociata. Stelo 175 mm.



**Sugar thermometer**

Termometro per zucchero  
Zuckerthermometer  
Thermomètre à sucre  
Termómetro azúcar

art. l. cm. scala range  
47843-00 30 1°C +80+200°C

Stainless steel housing. – Guaina inox.



**Sugar/jam thermometer**

Termometro per zucchero/marmellata  
Zucker- und Marmeladenthermometer  
Thermomètre à sucre et confiture  
Termómetro azúcar y mermelada

art. scala range  
47843-05 2°C +40+200°C

Brass. – Ottone. Dim. 4,7x20 cm.



**Baker's thermometer**

Termometro per panettiere  
Bäckerthermometer  
Thermomètre boulanger  
Termómetro panadero

art. l. cm. scala range  
49712-00 30 1°C -10+60°C

Plastic housing. – Guaina plastica.



SS

**Oven thermometer**

Termometro per forno  
Ofenthermometer  
Thermomètre à four  
Termómetro horno

art. Ø cm. scala range  
19709-00 7 10°C +38+316°C



ABS

**Fridge/freezer thermometer**

Termometro frigo/freezer  
Kühlschrank-Thermometer  
Thermomètre à réfrigérateur  
Termómetro congelador

art. Ø cm. scala range  
49885-02 7 1°C -50+50°C



SS

**Fridge/freezer thermometer**

Termometro frigo/freezer  
Kühlschrank-Thermometer  
Thermomètre à réfrigérateur  
Termómetro congelador

art. Ø cm. scala range  
19702-00 6 1°C -29+27°C



ABS

**Digital thermometer**

Termometro digitale  
Digitalthermometer  
Thermomètre digitale  
Termómetro digital

art. scala range  
49887-00 0,1°C -50+70°C

Dim. cm. 1,5x5x7



**Digital fridge thermometer**

Termometro digitale per frigorifero  
Kühlschrank-Digitalthermometer  
Thermomètre digitale à réfrigérateur  
Termómetro digital para refrigerador

art. scala range  
49887-02 0,1°C -9,9+49,9°C

**Dim. Cm. 2,6x4,5x7,3. Water resistant IP65. Features a food safety zone icon in the display that indicates when the temperature is outside the range of 0 to 5°C. – Resistente all'acqua IP65. Un'icona indica sul display quando la temperatura è al di fuori dell'intervallo da 0 a 5°C.**

**ABS**



**Room/wall thermometer**

Termometro da muro  
Wandthermometer  
Thermomètre à mur  
Termómetro de pared

art. scala range  
49702-00 1°C -30+50°C

**Dim. cm. 20,5x4. Without mercury. – Senza mercurio.**



**Pocket thermometer**

Termometro da tasca  
Taschenthermometer  
Thermomètre à poche  
Termómetro digital

art. l. cm. scala range  
19701-00 15 0,1°C -50+150°C



**Digital thermometer**

Termometro digitale  
Digitalthermometer  
Thermomètre digitale  
Termómetro digital

art. scala range  
49710-00 1°C -50+300°C

**IP 65. Probe 135 mm. ø 2,5 mm. Sonda 135 mm. ø 2,5 mm.**



**Pocket thermometer**

Termometro da tasca  
Taschenthermometer  
Thermomètre à poche  
Termómetro digital

art. scala range  
49701-00 0,1°C -50+200°C

**Probe 125 mm. ø 3,5 mm. Sonda 125 mm. ø 3,5 mm.**



**Digital thermometer**

Termometro digitale  
Elektronisches Thermometer  
Thermomètre digital  
Termómetro digital

art. scala range  
49715-00 0,1°C -50+300°C

**Probe 125 mm. ø 3,5 mm. Sonda 125 mm. ø 3,5 mm.**



**Digital thermometer**

Termometro digitale  
Elektronisches Thermometer  
Thermomètre digital  
Termómetro digital

art. scala range  
49716-00 0,1°C -50+300°C

**Dim. cm. 1,9x7x15,2. Countdown/up 99h-59m.**



**Digital thermometer**

Termometro digitale  
Elektronisches Thermometer  
Thermomètre digital  
Termómetro digital

art. scala range  
49883-00 0,1°C -50+300°C

**Dim. cm. 13x5,5x2,5. Probe 13 cm. ABS case incl. Biomaster AT. – Involucro ABS con Biomaster. Sonda 13 cm.**





**Multi-function thermometer**

Termometro multifunzione  
Multifunktions-Thermometer  
Thermomètre multifonction  
Termómetro multifunción

art. scala range  
49988-00 0,1°C -19,9+149,9°C

**Dim. cm. 2,5x7,3x12,3. Probe 125 mm. ø 3,5.**  
**Housing & probe handle incl. Biomaster AT.**  
Involucro e manico sonda con Biomaster. Sonda 125 mm. ø 3,5.



**Infrared thermometer**

Termometro a infrarossi  
Infrarot-Thermometer  
Thermomètre infrarouge  
Termómetro infrarrojo

art. scala range  
49986-00 0,1°C -49,9+349,9°C

**Dim. cm. 2,5x5,2x10**



**Infrared thermometer**

Termometro a infrarossi  
Infrarot-Thermometer  
Thermomètre infrarouge  
Termómetro infrarrojo

art. scala  
49884-08 0,1/1°C

**Dim. cm. 4x6,6x15,5. Range infrared-Infrarossi: -60 to 500°C – Range probe-Sonda: -64 to 1370°C.**



**Infrared thermometer**

Termometro a infrarossi  
Infrarot-Thermometer  
Thermomètre infrarouge  
Termómetro infrarrojo

art. scala range  
49717-00 1°C -50+400°C

**Dim. cm. 17,5x4x7,2**



**Infrared thermometer**

Termometro a infrarossi  
Infrarot-Thermometer  
Thermomètre infrarouge  
Termómetro infrarrojo

art. scala range  
49987-00 0,1°C -50+330°C

**Dim. cm. 3,6x8,8x13,1**



**Waterproof thermometer**

Termometro waterproof  
Waterproof-Thermometer  
Thermomètre waterproof  
Termómetro waterproof

art. scala range  
49711-00 0,1°C -50+300°C

**Dim. Ø 51x178 mm. Waterproof IP66. Auto-rotating display. S/steel penetration probe Ø 2,5x70 mm stainless steel, Ø 1,6 mm tip.**  
Impermeabile IP66. Display a rotazione automatica. Sonda di penetrazione inox Ø 2,5x70 mm., punta Ø 1,6 mm.



**Spatula with thermometer**

Spatola con termometro  
Rührspaten mit Thermometer  
Spatule avec thermomètre  
Espátula con termómetro

art. range  
49729-00 -50+300°C

**Dim. cm. 26x4x1,8**





**Digital thermometer**

Termometro digitale  
Elektronisches Thermometer  
Thermomètre digital  
Termómetro digital

art.	scala	range	col.
49880-10	0,1/1°C	-49,9+299,9°C	●
49880-11	0,1/1°C	-49,9+299,9°C	●
49880-12	0,1/1°C	-49,9+299,9°C	●

**Dim. cm. 1,9x5x15,7. IP66/67. S/steel probe Ø 3,3 x 115 mm. folds back through 180°.**



**Digital thermometer**

Termometro digitale  
Elektronisches Thermometer  
Thermomètre digital  
Termómetro digital

art.	scala	range	col.
49880-13	0,1/1°C	-49,9+299,9°C	●
49880-14	0,1/1°C	-49,9+299,9°C	●
49880-15	0,1/1°C	-49,9+299,9°C	○

**Sonda inox ø 3,3 x 115 mm. pieghevole a 180°.**



**Digital thermometer**

Termometro digitale  
Elektronisches Thermometer  
Thermomètre digital  
Termómetro digital

art.	scala	range	col.
49880-17	0,1/1°C	-49,9+299,9°C	●

**Dim. cm. 1,9x5x15,7. IP66/67. S/steel probe Ø 3,3 x 115 mm. folds back through 180°. IP66/67. Sonda inox ø 3,3 x 115 mm. pieghevole a 180°.**



**Sous vide cooking thermometer**

Termometro per sottovuoto  
Vakuum-Koch-Thermometer  
Thermomètre pour cuisson sous-vide  
Termómetro cocción al vacío

art.	scala	range
49881-01	0,1°C	-99,9+299,9°C 1°C +300+1372°C

**Kit: thermometer, Sous-Vide needle probe 60 mm., one metre foam/tape, zip pouch, free traceable certificate of calibration.**

Kit: termometro, sonda per sottovuoto 60 mm., 1 metro di nastro adesivo, astuccio con zip, certificato di calibrazione tracciabile.



**Sous vide cooking thermometer**

Termometro per sottovuoto  
Vakuum-Koch-Thermometer  
Thermomètre pour cuisson sous-vide  
Termómetro cocción al vacío

art.	scala	range
49881-11	0,1°C	-49,9+299,9°C

**Dim. 1,9x4,7x15,3 cm. S/steel needle probe Ø 1,1 x 60 mm. FREE traceable certificate of calibration incl. – Sonda ad ago inox Ø 1,1 x 60 mm. Certificato di calibrazione incl.**



**Sous vide foam tape**

Nastro adesivo per sottovuoto  
Vakuumschaumklebeband  
Ruban adhésif pour sous-vide  
Cinta adhesiva para cocción al vacío

art.	l. cm.
49881-99	100

**Used in conjunction with thermometer to measure the core temperature without suffering water ingress into vacuum sealed bag.**

Utilizzato in combinazione con il termometro evita che penetri acqua nel sacchetto sotto vuoto.



**Digital oven thermometer**

Termometro digitale da forno  
Ofen-Digitalthermometer  
Thermomètre à four digital  
Termómetro horno digital

art.	Ø cm.	scala	range
49719-00	8	1°C/F	-50+300°C

**Loud 70dB audible temperature alarm. 114 mm probe with 1,2 metre s/s braided lead that allows the probe to remain in the food during cooking. Water/dust resistance: IP65 protection.**

Allarme acustico 70dB. Sonda 114 mm., cavo inox 1,2 metri che permette l'utilizzo durante la cottura. Resistenza acqua/polvere. IP65.



**Waterproof digital timer**

Timer digitale a tenuta stagna  
Wasserdichte Digitaltimer  
Timer digital étanche  
Reloj digital impermeable

art.	Ø cm.	h.
49733-00	8	17

**IP 65. 99M-99S. Dust and flour proof. Sound and flashing alarms. Hanging hook and suction cup. – A prova di polvere e farina. Suono e allarme lampeggiante. Gancio e ventosa.**



**Digital timer**

Timer digitale  
Digitalkochalarm  
Minuterie digitale  
Reloj digital

art. cm.  
49720-00 7x5,5

**Timer 23H-59M-59S. Clock 12H AM/PM. Count down. 80dB audible alarm. Magnetic pad.**

Orologio 12H AM/PM. Cronometro. Allarme acustico 80dB. Attacco magnetico.



**Digital timer**

Timer digitale  
Digitalkochalarm  
Minuterie digitale  
Reloj digital

art. cm.  
49734-00 9x4,7x4,5

**Count-down/up: 23H 59M 59S. 80 dB sound. 1 AAA battery.**



**Digital timer jumbo**

Timer digitale gigante  
Digitalkochalarm jumbo  
Minuterie digitale géante  
Reloj digital gigante

art. cm.  
49735-00 13,5x9,5x16

**80dB sound. 4 programs. Electrical plug & battery. Waterproof front panel IP54.**

Presa elettrica e batteria. Pannello frontale impermeabile IP54.



ABS

**Thermohygrometer with clock**

Termoigrometro con orologio  
Thermohygrometer mit Uhr  
Thermohygromètre avec horloge  
Termohigrómetro con reloj

art. cm. range  
49721-03 13x10x2,5 -20+50°C

**10-99% RH - 12/24 H.**



**Syrup hydrometer**

Densimetro per sciroppo  
Sirup-Hydrometer  
Hydromètre à sirop  
Hidrómetro de jarabe

art. l. cm.  
49703-00 12,5

**1100-1400 g/m - 15-40°Bé**



**Hydrometer for brine and salt**

Densimetro per salamoia e sale  
Hydrometer für Sole und Salz  
Hydromètre à saumure et sel  
Hidrómetro de salmuera y sal

art. l. cm.  
49730-20 19,5

**1000-1250 g/m - 0-30°Bé**



ABS

PP

**Salt tester and thermometer**

Salinometro e termometro  
Salzgehalt-Meter u. Thermometer  
Testeur de salinité et thermometer  
Salinometro y termómetro

art. cm.  
49730-00 3,2x1,6x22,5

**To measure the salt content of food and liquids in percentage from 0 to 5%. Temperature from 0°+100°C. – Per misurare il tenore di sale in alimenti e liquidi in percentuale da 0 a 5%. Temperatura da 0°+100° C.**



**Frying oil test strips**

Strisce reattive per oli di frittura  
Bratöl-Teststreifen  
Bandes réactives pour les huiles de friture  
Tiras reactivas para control aceites

art.  
49731-99

**Storage bottles of 100 Oil Quality Test Strips and easy to read colour chart. Hold the test strip in the oil for 2 seconds (max 40°C), then remove it and wait 2 minutes, next, compare the strip to the colour chart. – Flacone con 100 strisce reattive e tabella colori di facile lettura. Immergere la fascia colorata della striscia nell'olio (max. 40°C) per 2 secondi, quindi rimuoverla e attendere 2 minuti. Confrontare la striscia con la tabella colori.**







**Frying oil tester & thermometer**

Tester e termometro per oli di frittura  
Bratöltester und Thermometer

Testeur et thermomètre des huiles de friture  
Medidor y termómetro para aceites

art. scala range  
49723-00 0,1°C +30+200°C

**Dim. 3,1x4,8x36,5 cm. Suitable for measuring olive oil, palm oil, rapeseed oil, peanut oil, soybean oil, sesame oil, vegetable oils and animal fats. IP65.** – Adatto per misurare olio di oliva, palma, colza, arachidi, soia, sesamo, oli vegetali e grassi animali. IP65.



**Frying oil tester**

Test degradazione oli di frittura  
Kontrollsystem für Bratenöle  
Test dégradation des huiles de friture  
Test para control aceites

art.  
49731-10

**Consisting of two reagents that are not harmful to health and environmentally friendly. For 20 tests. ATTENTION: works with all types and brands of frying oil, (except with palm oil).** – Composto da due reagenti non nocivi per la salute e rispettosi dell'ambiente. Per 20 test. ATTENZIONE: funziona con tutti i tipi e le marche di olio di frittura, (tranne che con l'olio di palma).

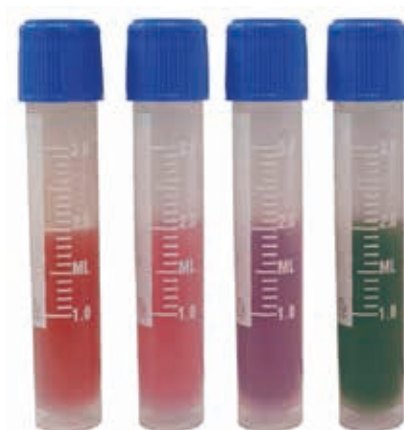

- 😊 **NEW OIL <9% of polar compounds**  
OLIO NUOVO <9% di composti polari
- 😊 **GOOD OIL from 10 to 16% of polar compounds**  
OLIO BUONO da 10 a 16% di composti polari
- 😞 **DETERIORATED OIL from 17 to 23% of polar compounds**  
OLIO DETERIORATO da 17 a 23% di composti polari
- 😡 **OIL TO CHANGE >24% of polar compounds**  
OLIO DA CAMBIARE >24% di composti polari



**Labels solvable**

Etichette dissolvibili  
Lösbare Etiketten  
Etiquettes solubles  
Etiquetas solubles

art. cm. pcs/pz  
44630-01 7,5x4 250

**Dissolvable in less than 20 seconds. Suitable for any type of surface.** – Dissolvibili in meno di 20 secondi. Adatte a qualsiasi tipo di superficie.



**Labels 14 allergens**

Etichette 14 allergeni  
Etiketten 14 Allergene  
Etiquettes 14 allergènes  
Etiquetas 14 alergenos

art. cm. pcs/pz  
44630-02 7,5x4 500

**Labels with all 14 allergens pre-printed.**  
Etichette con i 14 allergeni prestampati.



**Labels Express 7 days**

Etichette express 7giorni  
Etiketten Express 7 Tage  
Etiquettes express 7 jours  
Etiquetas express 7 días

art. cm. pcs/pz  
44630-03 3x2,5 1750

**Different colors based on the day of the week. Data to be written: product description; date of production or expiry date.** – Diversi colori in base al giorno della settimana. Dati da inserire: descrizione del prodotto; data di produzione o data di scadenza.





**Labels frozen food**

Etichette frozen/surgelati  
Etiketten Tiefkühlkost  
Etiquettes aliments surgelés  
Etiquetas alimentos congelados

art. cm. pcs/pz  
44630-04 7x4,5 500

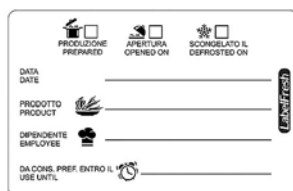

**Labels TMC**

Etichette TMC  
Etiketten TMC  
Etiquettes TMC  
Etiquetas TMC

art. cm. pcs/pz  
44630-05 7x4,5 500

**TMC: Termine minimo di conservazione.**

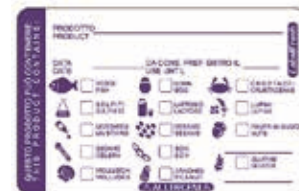

**Labels Allergens**

Etichette allergeni  
Etiketten Allergene  
Etiquettes allergènes  
Etiquetas alérgenos

art. cm. pcs/pz  
44630-06 7x4,5 500



**Labels delivery with allergens**

Etichette delivery con allergeni  
Etiketten Lieferung mit Allergenen  
Etiquettes livraison avec allergènes  
Etiquetas entrega con alérgenos

art. cm. pcs/pz  
44630-07 14x4,5 250



**Wall clock ORION**

Orologio da parete  
Wanduhr  
Horloge à paroi  
Reloj de pared

art. Ø cm.  
41380-01 29

**Satin alloy. – Metallo satinato.**



**Wall clock SILENT**

Orologio da parete  
Wanduhr  
Horloge à paroi  
Reloj de pared

art. Ø cm.  
41380-02 30,5

**Silent clock. – Movimento silenzioso.**



ABS  
SS

**Digital scale**

Bilancia digitale  
Präzisionswaage  
Balance digitale  
Balanza digital

art. cm. Kg. scala  
49865-06 21,6x17,1x6,3 6 1g

**Antimicrobial protection. Portion count. Removable platform cm 14,6x16,5. AC adapter/batteries supply. – Protezione antimicrobica. Conteggio porzioni. Piattaforma cm 4,6x16,5. Adattatore AC/batterie.**



**Digital scale**

Bilancia digitale  
Präzisionswaage  
Balance digitale  
Balanza digital

art. cm. Kg. scala  
49865-70 30,5x31,8x5,7 68 100g

**Platform cm 30,5x30,5. Remote LCD wall mount display. Electric or batteries supply. Piattaforma cm 30,5x30,5. Schermo LCD rimovibile per montaggio a parete. Alimentazione corrente/batteria.**



ABS





SS

**Mechanical scale**  
Bilancia meccanica  
Waage  
Balance  
Balanza

art.	Ø cm.	Kg.	scala
49864-03	20	3	10g
49864-05	20	5	20g



SS

**Mechanical scale**  
Bilancia meccanica  
Waage  
Balance  
Balanza

art.	Ø cm.	Kg.	scala
49864-20	25	20	100g



SS

**Digital kitchen scale**  
Bilancia digitale da cucina  
Digital-Küchenwaage  
Balance de cuisine  
Balanza digital de cocina

art.	cm.	Kg.	scala
49773-05	21,5x13	5	1g



SS

ABS

**Digital kitchen scale**  
Bilancia digitale da cucina  
Digital-Küchenwaage  
Balance de cuisine  
Balanza digital de cocina

art.	cm.	Kg.	scala
49774-05	22,5x16,5x2	5	1g



**Pocket scale**  
Bilancia tascabile  
Taschenwaage  
Balance de poche  
Balanza de bolsillo

art.	cm.	Kg.	scala
49771-00	15x10x2,5	0,25	0,1 g



SS

ABS

**Pocket scale**  
Bilancia tascabile  
Taschenwaage  
Balance de poche  
Balanza de bolsillo

art.	cm.	Kg.	scala
49772-01	12,7x7,6x2	1	0,1 g



ABS

SS

**Digital scale**  
Bilancia digitale  
Digitalwaage  
Balance digitale  
Balanza digital

art.	cm.	Kg.	scala
49775-05	24,5x31x9,5	5	1g
49775-10	24,5x31x9,5	10	1g



ABS

SS

**Digital scale**  
Bilancia digitale  
Digitalwaage  
Balance digitale  
Balanza digital

art.	cm.	Kg.	scala
49777-50	29x33,5x11	50	1g

Unit: Kg/lb.



SS

**Digital scale**  
 Bilancia digitale  
 Digitalwaage  
 Balance digitale  
 Balanza digital

art.	cm.	Kg.	scala
49776-15	24x29x11	15	1g
49776-30	24x29x11	30	2g



ABS

SS

**Digital scale with platform**  
 Bilancia digitale con piattaforma  
 Digitalwaage mit Plattform  
 Balance digitale avec plate-forme  
 Balanza digital con plataforma

art.	cm.	Kg.	scala
49779-15	50x40x84	150	20g
49779-30	60x50x84	300	50g





# SERIES 18100

FORGED KNIVES  
COLTELLI FORGIATI



A deep study and computerised tests of ergonomics, movement and posture have allowed Paderno to create a professional knives line, that is the synthesis of comfort and cutting precision. Handle made of plastic specially developed for the food processing sector, ergonomic design with soft edges, perfect grip to ensure precise guidance. The forged blade realised in special steel and molybdenum/vanadium, thanks to a peculiar hardening process, guarantees to the product a perfect cut and a long life of the blade's edge.

Uno studio approfondito e prove computerizzate di ergonomia, movimento e postura hanno permesso a Paderno di creare una linea di coltelli professionali, sintesi perfetta tra comfort e perfezione del taglio. Manico realizzato in speciale materiale plastico sviluppato per il settore alimentare, design ergonomico con bordi arrotondati, presa perfetta per garantire un taglio di precisione. Lama forgiata realizzata in lega di speciale acciaio, molibdeno e vanadio con particolare processo di tempra che garantisce al prodotto un ottimo taglio ed una perfetta e lunga tenuta di filo.





**Cook's knife**

Coltello cucina  
Kochmesser  
Couteau cuisine  
Cuchillo de cocinero

art.	cm.
18100-16	16
18100-20	20
18100-24	24
18100-30	30
18100-36	36



**Butcher's knife**

Coltello francese  
Blockmesser  
Couteau de chef  
Cuchillo de carnicero

art.	cm.
18102-16	16
18102-20	20
18102-26	26
18102-30	30



**Oriental knife**

Coltello orientale  
Japanisches Kochmesser  
Couteau de chef japonais  
Cuchillo santoku

art.	cm.
18103-18	18



**Oriental knife, scalloped edge**

Coltello orientale, alveolato  
Japanisches Kochmesser mit Kullenschliff  
Couteau de chef japonais alveolé  
Cuchillo santoku alveolado

art.	cm.
18104-18	18



**Slicing knife**

Coltello affettare  
Fleischmesser  
Tranchelard  
Cuchillo trinchante

art.	cm.
18106-15	15
18106-20	20
18106-25	25
18106-30	30



**Ham knife**

Coltello prosciutto  
Schinkenmesser  
Trancheur à jambon  
Cuchillo para jamón

art.	cm.
18109-26	26
18109-30	30
18109-36	36



**Ham knife, scalloped edge**

Coltello prosciutto, alveolato  
Schinkenmesser mit Kullenschliff  
Couteau à jambon alvéolé  
Cuchillo para jamón alveolado

art.	cm.
18110-26	26
18110-30	30
18110-36	36



**Salmon knife**

Coltello salmone  
Lachsmesser  
Couteau à saumon  
Cuchillo para salmón

art.	cm.
18111-30	30



**Salmon knife, scalloped edge**

Coltello salmone, alveolato  
Lachsmesser mit Kullenschliff  
Couteau à saumon alvéolé  
Cuchillo para salmón alveolado

art.	cm.
18112-30	30



**Carving knife**

Coltello trinciante  
Tranchiermesser  
Couteau à découper  
Cuchillo trinchante

art.	cm.
18114-20	20





**Filleting knife, flexible**

Coltello filettare, flessibile  
Filiermesser, flexibel  
Couteau filet de sole, flexible  
Cuchillo para filetear, flexible

art.	cm.
18115-20	20
18115-25	25



**Boning knife**

Coltello disosso  
Ausbeinmesser  
Couteau à désosser  
Cuchillo deshuesador

art.	cm.
18116-14	14
18116-18	18



**Steak knife serrated**

Coltello bistecca seghettato  
Steakmesser Wellenschliff  
Couteau à steak dentelé  
Cuchillo steak filo ondulado

art.	cm.
18122-12	12



**Paring knife**

Spelucchino  
Spickmesser  
Couteau d'office  
Cuchillo mondador

art.	cm.
18124-09	9



**Paring knife**

Spelucchino  
Spickmesser  
Couteau d'office  
Cuchillo mondador

art.	cm.
18125-07	7
18125-10	10



**Bent paring knife**

Coltello cuoco  
Tourniermesser  
Couteau bec d'oiseau  
Cuchillo para pelar

art.	cm.
18126-07	7



**Table knife serrated**

Coltello tavola seghettato  
Tafelmesser Wellenschliff  
Couteau bout rond cranté  
Cuchillo mesa filo ondulado

art.	cm.
18123-11	11



**Bread knife**

Coltello pane  
Brotmesser  
Couteau à pain  
Cuchillo para pan

art.	cm.
18128-20	20
18128-24	24
18128-30	30



**Meat fork**

Forchettone  
Fleischgabel  
Fourchette baïonnette  
Tenedor trinchante

art.	cm.
18230-13	13
18230-17	17



**Carving fork**

Forchettone curvo  
Fleischgabel  
Fourchette courbe  
Tenedor trinchante

art.	cm.
18231-13	13

# SERIES 18000

STAMPED KNIVES  
COLTELLI TRANCIATI



The professional cutlery line "Color-Line" helps to reduce the risk of cross contamination using a Color Coding System which identifies each knife with a specific task: different food processing areas are easily identified. The steel used for this cutlery line has exceptional hardness and very high resistance to corrosion due to ICE-HARDENED system, a special process to harden the steel.

La linea di coltelleria professionale "CCS"– Color Coding System riduce i rischi di contaminazione incrociata grazie all'utilizzo di un Sistema di Codifica dei Colori che identifica ogni coltello per un uso specifico e permette di individuare facilmente le diverse aree di lavoro. Gli acciai utilizzati per questa linea di coltelleria presentano un'eccezionale durezza ed elevata resistenza alla corrosione, grazie all'uso del sistema ICE-HARDENING, processo speciale per temprare l'acciaio.



**Cook's knife**  
Coltello cucina  
Kochmesser  
Couteau de cuisine  
Cuchillo de cocinero

art.	cm.	col.
18000-16	16	●
18000-20	20	●
18000-23	23	●
18000-26	26	●
18000-30	30	●
18000-36	36	●



**Cook's knife**  
Coltello cucina  
Kochmesser  
Couteau de cuisine  
Cuchillo de cocinero

art.	cm.	col.
18000B16	16	●
18000B20	20	●
18000B23	23	●
18000B26	26	●
18000B30	30	●



**Cook's knife**  
Coltello cucina  
Kochmesser  
Couteau de cuisine  
Cuchillo de cocinero

art.	cm.	col.
18000G16	16	●
18000G20	20	●
18000G23	23	●
18000G26	26	●
18000G30	30	●



**Cook's knife**  
Coltello cucina  
Kochmesser  
Couteau de cuisine  
Cuchillo de cocinero

art.	cm.	col.
18000M16	16	●
18000M20	20	●
18000M23	23	●
18000M26	26	●



**Cook's knife**  
Coltello cucina  
Kochmesser  
Couteau de cuisine  
Cuchillo de cocinero

art.	cm.	col.
18000R16	16	●
18000R20	20	●
18000R23	23	●
18000R26	26	●
18000R30	30	●



**Cook's knife**  
Coltello cucina  
Kochmesser  
Couteau de cuisine  
Cuchillo de cocinero

art.	cm.	col.
18000W20	20	○
18000W26	26	○
18000W30	30	○



**Cook's knife**  
Coltello cucina  
Kochmesser  
Couteau de cuisine  
Cuchillo de cocinero

art.	cm.	col.
18000Y16	16	●
18000Y20	20	●
18000Y23	23	●
18000Y26	26	●



**Slaughter/Butcher's knife**  
Coltello scimitarra  
Schlacht U Fleischermesser  
Couteau à découper  
Cuchillo carnicero curvo

art.	cm.	col.
18005-22	22	●
18005-27	27	●
18005-32	32	●





**Slaughter/Butcher's knife**

Coltello scimitarra  
Schlacht U Fleischermesser  
Couteau à découper  
Cuchillo carnicero curvo

art.	cm.	col.
18005B22	22	●
18005B27	27	●
18005B32	32	●



**Slaughter/Butcher's knife**

Coltello scimitarra  
Schlacht U Fleischermesser  
Couteau à découper  
Cuchillo carnicero curvo

art.	cm.	col.
18005G22	22	●
18005G27	27	●
18005G32	32	●



**Slaughter/Butcher's knife**

Coltello scimitarra  
Schlacht U Fleischermesser  
Couteau à découper  
Cuchillo carnicero curvo

art.	cm.	col.
18005R22	22	●
18005R27	27	●
18005R32	32	●



**Slaughter/Butcher's knife**

Coltello scimitarra  
Schlacht U Fleischermesser  
Couteau à découper  
Cuchillo carnicero curvo

art.	cm.	col.
18005Y22	22	●
18005Y27	27	●
18005Y32	32	●



**Butcher's knife**

Coltello francese  
Blockmesser  
Couteau à découper  
Cuchillo carnicero

art.	cm.	col.
18002-18	18	●
18002-20	20	●
18002-22	22	●
18002-26	26	●
18002-30	30	●
18002-36	36	●



**Butcher's knife**

Coltello francese  
Blockmesser  
Couteau à découper  
Cuchillo carnicero

art.	cm.	col.
18002B26	26	●



**Butcher's knife**

Coltello francese  
Blockmesser  
Couteau à découper  
Cuchillo carnicero

art.	cm.	col.
18002R18	18	●
18002R20	20	●
18002R22	22	●
18002R26	26	●
18002R30	30	●
18002R36	36	●



**Butcher's knife**

Coltello francese  
Blockmesser  
Couteau à découper  
Cuchillo carnicero

art.	cm.	col.
18002Y18	18	●
18002Y26	26	●
18002Y30	30	●
18002Y36	36	●



**Slicing knife**

Coltello affettare  
Wurstmesser  
Couteau à trancher  
Cuchillo trinchante

art.	cm.	col.
18006-20	20	●
18006-25	25	●
18006-30	30	●
18006-36	36	●



**Slicing knife**

Coltello affettare  
Wurstmesser  
Couteau à trancher  
Cuchillo trinchante

art.	cm.	col.
18006B20	20	●
18006B25	25	●
18006B30	30	●



**Slicing knife**

Coltello affettare  
Wurstmesser  
Couteau à trancher  
Cuchillo trinchante

art.	cm.	col.
18006G20	20	●
18006G25	25	●



**Slicing knife**

Coltello affettare  
Wurstmesser  
Couteau à trancher  
Cuchillo trinchante

art.	cm.	col.
18006R20	20	●
18006R25	25	●
18006R30	30	●



**Slicing knife**

Coltello affettare  
Wurstmesser  
Couteau à trancher  
Cuchillo trinchante

art.	cm.	col.
18006Y20	20	●
18006Y25	25	●
18006Y30	30	●



**Slicing knife, wavy blade**

Coltello affettare, dentato  
Wurstmesser mit Wellenschliff  
Couteau à trancher dentelé  
Cuchillo trinchante ondulado

art.	cm.	col.
18007-25	25	●
18007-30	30	●
18007-36	36	●



**Slicing knife, wavy blade**

Coltello affettare, dentato  
Wurstmesser mit Wellenschliff  
Couteau à trancher dentelé  
Cuchillo trinchante ondulado

art.	cm.	col.
18007G30	30	●



**Cook's knife**

Coltello cucina  
Kochmesser  
Couteau de cuisine  
Cuchillo de cocinero

art.	cm.	col.
18008-20	20	●
18008-26	26	●
18008-30	30	●
18008-36	36	●



**Cook's knife**

Coltello cucina  
Kochmesser  
Couteau de cuisine  
Cuchillo de cocinero

art.	cm.	col.
18008B30	30	●



**Cook's knife**

Coltello cucina  
Kochmesser  
Couteau de cuisine  
Cuchillo de cocinero

art.	cm.	col.
18008R26	26	●
18008R30	30	●
18008R36	36	●



**Cook's knife**

Coltello cucina  
Kochmesser  
Couteau de cuisine  
Cuchillo de cocinero

art.	cm.	col.
18008Y30	30	●



**Ham knife**

Coltello prosciutto  
Schinkenmesser  
Trancheur à jambon  
Cuchillo para jamón

art.	cm.	col.
18009-25	25	●
18009-30	30	●
18009-36	36	●



**Ham knife**

Coltello prosciutto  
Schinkenmesser  
Trancheur à jambon  
Cuchillo para jamón

art.	cm.	col.
18009B25	25	●
18009B30	30	●



**Ham knife**

Coltello prosciutto  
Schinkenmesser  
Trancheur à jambon  
Cuchillo para jamón

art.	cm.	col.
18009M25	25	●



**Ham knife**

Coltello prosciutto  
Schinkenmesser  
Trancheur à jambon  
Cuchillo para jamón

art.	cm.	col.
18009R25	25	●
18009R30	30	●



**Ham knife**

Coltello prosciutto  
Schinkenmesser  
Trancheur à jambon  
Cuchillo para jamón

art.	cm.	col.
18009W25	25	○
18009W30	30	○



**Ham knife**

Coltello prosciutto  
Schinkenmesser  
Trancheur à jambon  
Cuchillo para jamón

art.	cm.	col.
18009Y25	25	●
18009Y30	30	●



**Salmon knife**

Coltello salmone  
Lachsmesser  
Couteau à saumon  
Cuchillo salmón

art.	cm.	col.
18011-32	32	●



**Ham knife, scalloped edge**

Coltello prosciutto, alveolato  
Schinkenmesser mit Kullenschliff  
Couteau à jambon alvéolé  
Cuchillo para jamón alveolado

art.	cm.	col.
18010-25	25	●
18010-30	30	●
18010-36	36	●



**Ham knife, scalloped edge**

Coltello prosciutto, alveolato  
Schinkenmesser mit Kullenschliff  
Couteau à jambon alvéolé  
Cuchillo para jamón alveolado

art.	cm.	col.
18010Y30	30	●



**Salmon knife, scalloped edge**

Coltello salmone, alveolato  
Lachsmesser mit Kullenschliff  
Couteau à saumon alvéolé  
Cuchillo salmón alveolado

art.	cm.	col.
18012-32	32	●
18012B32	32	●



**Cheese slicer**

Coltello salati/formaggio  
Universalmesser  
Couteau universel  
Cuchillo universal

art.	cm.	col.
18013-30	30	●
18013-36	36	●



**Cheese slicer**

Coltello salati/formaggio  
Universalmesser  
Couteau universel  
Cuchillo universal

art.	cm.	col.
18013G36	36	●



**Cheese slicer**

Coltello salati/formaggio  
Universalmesser  
Couteau universel  
Cuchillo universal

art.	cm.	col.
18013W30	30	○
18013W36	36	○



**Filleting knife**

Coltello filettare  
Filiermesser  
Couteau filet de sole  
Cuchillo fileteador

art.	cm.	col.
18015-18	18	●
18015-22	22	●
18015-27	27	●



**Filleting knife**

Coltello filettare  
Filiermesser  
Couteau filet de sole  
Cuchillo fileteador

art.	cm.	col.
18015B18	18	●
18015B22	22	●



**Filleting knife**

Coltello filettare  
Filiermesser  
Couteau filet de sole  
Cuchillo fileteador

art.	cm.	col.
18015R18	18	●
18015R22	22	●



**Filleting knife**

Coltello filettare  
Filiermesser  
Couteau filet de sole  
Cuchillo fileteador

art.	cm.	col.
18015Y18	18	●
18015Y27	27	●



**Boning knife**

Coltello disosso  
Ausbeinmesser  
Couteau à désosser  
Cuchillo deshuesador

art.	cm.	col.
18016-14	14	●
18016-16	16	●



**Boning knife**

Coltello disosso  
Ausbeinmesser  
Couteau à désosser  
Cuchillo deshuesador

art.	cm.	col.
18016B14	14	●
18016B16	16	●



**Boning knife**

Coltello disosso  
Ausbeinmesser  
Couteau à désosser  
Cuchillo deshuesador

art.	cm.	col.
18016R14	14	●
18016R16	16	●



**Boning knife**

Coltello disosso  
Ausbeinmesser  
Couteau à désosser  
Cuchillo deshuesador

art.	cm.	col.
18016W16	16	○





**Boning knife**

Coltello disosso  
Ausbeinmesser  
Couteau à désosser  
Cuchillo deshuesador

art.	cm.	col.
18016Y14	14	●
18016Y16	16	●



**Boning knife**

Coltello disosso Emilia  
Ausbeinmesser  
Couteau à désosser  
Cuchillo deshuesador

art.	cm.	col.
18017-14	14	●
18017-16	16	●
18017-18	18	●



**Boning knife**

Coltello disosso Emilia  
Ausbeinmesser  
Couteau à désosser  
Cuchillo deshuesador

art.	cm.	col.
18017B16	16	●
18017R16	16	●
18017Y16	16	●



**Poultry sticking knife**

Coltello scannapolli  
Geflügelschlachtmesser  
Couteau à volaille  
Cuchillo deshuesador

art.	cm.	col.
18018-11	11	●
18018R11	11	●
18018Y11	11	●



**Sticking knife**

Coltello scannare  
Stechmesser  
Couteau à saigner  
Cuchillo deshuesador

art.	cm.	col.
18019-12	12	●
18019-14	14	●
18019-16	16	●
18019-18	18	●
18019-20	20	●



**Sticking knife**

Coltello scannare  
Stechmesser  
Couteau à saigner  
Cuchillo deshuesador

art.	cm.	col.
18019R12	12	●
18019R16	16	●
18019R18	18	●
18019R20	20	●



**Frozen food, two serrated edges**

Coltello surgelati a doppia lama seghettata  
Tiefkühlkost-Messer  
Couteau à surgelés  
Cuchillo de congelado

art.	cm.	col.
18020-23	23	●
18020B23	23	●
18020R23	23	●



**Frozen food special serrated blade**

Coltello surgelati lama seghettata speciale  
Tiefkühlkost-Messer  
Couteau à surgelés  
Cuchillo de congelado

art.	cm.	col.
18021-18	18	●
18021B18	18	●
18021R18	18	●



**Steak knife**

Coltello bistecca  
Steakmesser  
Couteau à steak  
Cuchillo para steak

art.	cm.	col.
18022-12	12	●



**Table knife, half-waved**

Coltello tavola, mezzo dentato  
Tafelmesser halb gewellt  
Couteau universel, demi-dentelée  
Cuchillo mesa, medio dentado

art.	cm.	col.
18023-11	11	●



**Steak/Pizza knife**

Coltello bistecca/pizza  
Steak-/Pizzamesser  
Couteau à steak/pizza  
Cuchillo para steak/pizza

art.	cm.	U. Pack	col.
18217-12	12	6	●



**Paring knife**

Spelucchino  
Spickmesser  
Couteau d'office  
Cuchillo mondador

art.	cm.	col.
18024B08	8	●
18024B11	11	●



**Paring knife**

Spelucchino  
Spickmesser  
Couteau d'office  
Cuchillo mondador

art.	cm.	col.
18024M08	8	●
18024M11	11	●



**Paring knife**

Spelucchino  
Spickmesser  
Couteau d'office  
Cuchillo mondador

art.	cm.	col.
18024W08	8	○
18024W11	11	○



**Bent paring knife**

Coltello cuoco  
Tourniermesser  
Couteau bec d'oiseau  
Cuchillo para pelar

art.	cm.	col.
18026-07	7	●
18026B07	7	●



**Confectioner's knife**

Coltello pasticceria  
Bäckmesser  
Couteau de pâtissier  
Cuchillo de pastelero

art.	cm.	col.
18029-25	25	●
18029-30	30	●
18029-36	36	●



**Paring knife**

Spelucchino  
Spickmesser  
Couteau d'office  
Cuchillo mondador

art.	cm.	col.
18024-08	8	●
18024-11	11	●



**Paring knife**

Spelucchino  
Spickmesser  
Couteau d'office  
Cuchillo mondador

art.	cm.	col.
18024G08	8	●
18024G11	11	●



**Paring knife**

Spelucchino  
Spickmesser  
Couteau d'office  
Cuchillo mondador

art.	cm.	col.
18024R08	8	●
18024R11	11	●



**Paring knife**

Spelucchino  
Spickmesser  
Couteau d'office  
Cuchillo mondador

art.	cm.	col.
18024Y08	8	●



**Bent paring knife**

Coltello cuoco  
Tourniermesser  
Couteau bec d'oiseau  
Cuchillo para pelar

art.	cm.	col.
18026G07	7	●
18026M07	7	●



**Confectioner's knife**

Coltello pasticceria  
Bäckmesser  
Couteau de pâtissier  
Cuchillo de pastelero

art.	cm.	col.
18029W25	25	○
18029W30	30	○
18029W36	36	○



**Bread knife**

Coltello pane  
Brotmesser  
Couteau à pain  
Cuchillo para pan

art.	cm.	col.
18028-21	21	●



**Bread knife**

Coltello pane  
Brotmesser  
Couteau à pain  
Cuchillo para pan

art.	cm.	col.
18028-25	25	●
18028-30	30	●
18028-36	36	●



**Bread knife**

Coltello pane  
Brotmesser  
Couteau à pain  
Cuchillo para pan

art.	cm.	col.
18028B30	30	●



**Bread knife**

Coltello pane  
Brotmesser  
Couteau à pain  
Cuchillo para pan

art.	cm.	col.
18028M25	25	●



**Bread knife**

Coltello pane  
Brotmesser  
Couteau à pain  
Cuchillo para pan

art.	cm.	col.
18028W21	21	○
18028W25	25	○
18028W30	30	○
18028W36	36	○



**Bread knife**

Coltello pane  
Brotmesser  
Couteau à pain  
Cuchillo para pan

art.	cm.	col.
18028Y25	25	●
18028Y30	30	●



**Pastry knife**

Coltello dolce  
Bäckermesser  
Couteau de pâtissier  
Cuchillo de pastelero

art.	cm.	col.
18030-26	26	●
18030-31	31	●
18030-36	36	●



**Pastry knife**

Coltello dolce  
Bäckermesser  
Couteau de pâtissier  
Cuchillo de pastelero

art.	cm.	col.
18030W26	26	○
18030W31	31	○
18030W36	36	○

SPECIAL ITEMS  
PEZZI SPECIALI







**Chinese meat cleaver**  
Falcetta cinese  
Chinesishackmesser  
Couteau de chef chinois  
Macheta Chino

art.	cm.	col.
18221-17	17	●
18221-19	19	●
18221-21	21	●



**Chinese meat cleaver**  
Falcetta cinese  
Chinesishackmesser  
Couteau de chef chinois  
Macheta Chino

art.	cm.	col.
18221B17	17	●
18221B19	19	●
18221B21	21	●



**Chinese meat cleaver**  
Falcetta cinese  
Chinesishackmesser  
Couteau de chef chinois  
Macheta Chino

art.	cm.	col.
18221G17	17	●
18221G19	19	●
18221G21	21	●



**Chinese meat cleaver**  
Falcetta cinese  
Chinesishackmesser  
Couteau de chef chinois  
Macheta Chino

art.	cm.	col.
18221M17	17	●
18221M19	19	●
18221M21	21	●



**Chinese meat cleaver**  
Falcetta cinese  
Chinesishackmesser  
Couteau de chef chinois  
Macheta Chino

art.	cm.	col.
18221R17	17	●
18221R19	19	●
18221R21	21	●



**Chinese meat cleaver**  
Falcetta cinese  
Chinesishackmesser  
Couteau de chef chinois  
Macheta Chino

art.	cm.	col.
18221Y17	17	●
18221Y19	19	●
18221Y21	21	●



**Meat cleaver**  
Falcetta macellaio  
Hackmesser  
Couperet  
Macheta

art.	cm.	Kg.	col.
18220-18	18	0,55	●
18220-20	20	1,10	●
18220-22	22	1,30	●
18220-26	26	1,30	●



**Meat cleaver**  
Falcetta macellaio  
Hackmesser  
Couperet  
Macheta

art.	cm.	Kg.	col.
18220B18	18	0,55	●
18220B20	20	1,10	●
18220B22	22	1,30	●
18220B26	26	1,30	●





**Meat cleaver**

Falcetta macellaio  
Hackmesser  
Couperet  
Macheta

art.	cm.	Kg.	col.
18220R18	18	0,55	●
18220R20	20	1,10	●
18220R22	22	1,30	●
18220R26	26	1,30	●



**Meat cleaver**

Falcetta macellaio  
Hackmesser  
Couperet  
Macheta

art.	cm.	Kg.	col.
18220Y18	18	0,55	●
18220Y20	20	1,10	●
18220Y22	22	1,30	●
18220Y26	26	1,30	●



**Heavy butcher's knife**

Mezzo colpo  
Kochschlagmesser  
Couteau coup lourd  
Cuchillo de carnicero

art.	cm.	Kg.	col.
18224-28	28	0,75	●
18224B28	28	0,75	●
18224R28	28	0,75	●
18224Y28	28	0,75	●



**Heavy butcher's knife**

Colpo  
Kochschlagmesser  
Couteau coup lourd  
Cuchillo de carnicero

art.	cm.	Kg.	col.
18225-28	28	1	●
18225R28	28	1	●



**Parmesan cheese knife**

Coltello grana  
Parmesanmesser  
Couteau à Parmesan  
Cuchillo Para Queso Parmenoso

art.	cm.	col.
18205-10	10	●



**Parmesan cheese knife**

Coltello grana  
Parmesanmesser  
Couteau à Parmesan  
Cuchillo Para Queso Parmenoso

art.	cm.	col.
18205-12	12	●



**Parmesan cheese knife**

Coltello segnaforme  
Parmesanmesser  
Couteau à Parmesan  
Cuchillo Para Queso Parmenoso

art.	cm.	col.
18206-09	9	●



**Parmesan cheese knife**

Coltello lancia Milano  
Parmesanmesser  
Couteau à Parmesan  
Cuchillo Para Queso Parmenoso

art.	cm.	col.
18207-15	15	●



**Oyster knife**

Coltello apriostriche  
Austernmesser  
Couteau à huîtres  
Cuchillo para ostras

art.	cm.	col.
18209-06	15	●



**Cheese knife 2 handles**

Coltello formaggio  
Käsemesser  
Couteau à fromage  
Cuchillo para queso

art.	cm.	col.
18201-36	36	●



**Vegetable knife**  
Coltello verdure  
Gemüsemesser  
Couteau à légumes  
Cuchillo para verduras

art.	cm.	col.
18222-18	18	●



**Ham boner**  
Cannula disosso prosciutti  
Schinkenauslöser  
Gouge à jambons  
Cuchillo deshuesar jamón

art.	cm.	col.
48021-21	21	●



**Cheese knife**  
Coltello formaggio  
Käsemesser  
Couteau à fromage  
Cuchillo para queso

art.	cm.	col.
18203-26	26	●



**Baking pan knife**  
Coltello gastronomia  
Winkelmesser  
Couteau à angle  
Cuchillo hoja angular

art.	cm.	col.
18215-13	13,5	●



**Baking pan knife**  
Coltello gastronomia  
Winkelmesser  
Couteau à angle  
Cuchillo hoja angular

art.	cm.	col.
18215-21	21,5	●



**Pie knife**  
Coltello torta  
Tortenmesser  
Couteau à gâteau  
Cuchillo para tartas

art.	cm.	col.
18514-18	18	●



**Mincing knife**  
Mezzaluna  
Wiegemesser  
Hachoir  
Media luna

art.	cm.	col.
48017-14	14	●
48017-25	26	●



**Double blade mincing knife**  
Mezzaluna, lama doppia  
Wiegemesser, Doppel-Klinge  
Hachoir double lame  
Media luna, doble

art.	cm.	col.
48215-14	14	●
48215-30	30	●



**Meat fork**  
Forchettone  
Fleischgabel  
Fourchette baïonnette  
Tenedor Trinchante

art.	cm.	col.
18226-17	17	●
18226B17	17	●
18226G17	17	●



**Meat fork**  
Forchettone  
Fleischgabel  
Fourchette baïonnette  
Tenedor Trinchante

art.	cm.	col.
18226R17	17	●
18226W17	17	○
18226Y17	17	●





**Sharpening steel**

Acciaino  
Wetzstahl  
Fusil  
Chaira

art.	cm.	col.
18235-26	26	●



**Sharpening steel**

Acciaino  
Wetzstahl  
Fusil  
Chaira

art.	cm.	col.
18235-30	30	●
18235B30	30	●
18235G30	30	●



**Sharpening steel**

Acciaino  
Wetzstahl  
Fusil  
Chaira

art.	cm.	col.
18235R30	30	●
18235W30	30	○
18235Y30	30	●



**Oval sharpening steel**

Acciaino ovale  
Wetzstahl, oval  
Fusil ovale  
Chaira ovalada

art.	cm.	col.
18236-30	30	●



**Diamond sharpening steel**

Acciaino diamantato  
Diamant-Wetzstahl  
Fusil diamant  
Chaira adiamantada

art.	cm.	col.
18237-26	26	●



**Sharpening stone GRIT 1000/240**

Pietra per affilare  
Abziehstein  
Pierre à aiguiser  
Piedra de afilar

art.	cm.
18251-01	21x7x3



**Sharpening stone GRIT 1000/600**

Pietra per affilare  
Abziehstein  
Pierre à aiguiser  
Piedra de afilar

art.	cm.
18251-02	21x7x3



**Poultry shears**

Trinciapollo  
Geflügelschere  
Coupe-volailles  
Tijeras aves

art.	cm.
18263-00	25



**Poultry scissors, divisible**

Forbice pollame, smontabile  
Geflügelschere, teilbar  
Coupe-volailles divisible  
Tijeras aves, desmontables

art.	cm.
18275-00	26,5



**Poultry shears, divisible**

Trinciapollo, smontabile  
Geflügelschere, teilbar  
Coupe-volailles divisible  
Tijeras aves, desmontables

art.	cm.
18261-00	24





**Seadfood scissors**

Forbice gamberi  
Meeresfrüchteschere  
Ciseaux à crevettes  
Tijeras camarónes

art. cm.  
18278-00 18



**Herb scissors, 5 blades**

Forbice erbe, 5 lame  
Kräuterschere 5 Klingen  
Ciseaux à herbes 5 lames  
Tijeras hierbas 5 Cuchillas

art. cm.  
18277-00 20



**Salad scissors**

Forbice insalata  
Salatschere  
Ciseaux à salade  
Tijeras ensalada

art. cm.  
18270-22 22



**Quail egg cutter**

Forbice uova di quaglia  
Wachteleierschere  
Ciseaux oeufs de caille  
Tijeras huevos de codorniz

art. cm.  
18279-14 14



**All purpose scissors**

Forbice multuso  
Küchenschere  
Ciseaux de cuisine  
Tijeras cocina

art. cm.  
18272-00 18,5



**Kitchen scissors, divisible**

Forbice cucina, smontabile  
Küchenschere, teilbar  
Ciseaux de cuisine, divisible  
Tijeras cocina, desmontables

art. cm.  
18271-00 22,6



**Kitchen scissors, divisible**

Forbice cucina, smontabile  
Küchenschere, teilbar  
Ciseaux de cuisine, divisible  
Tijeras cocina, desmontables

art. cm.  
18273-00 18



**Kitchen scissors, divisible**

Forbice cucina, smontabile  
Küchenschere, teilbar  
Ciseaux de cuisine, divisible  
Tijeras cocina, desmontables

art. cm.  
18274-00 20



**Chinese kitchen scissors**

Forbice cinese cucina  
Chinesische Küchenschere  
Ciseaux chinois de cuisine  
Tijeras chinas de cocina

art. cm.

49636-00 17x8,5

**Stainless steel and brass. – Inox e ottone.**



**Pizza scissors, divisible**

Forbice pizza, smontabile  
Pizzaschere, teilbar  
Ciseaux à pizza, divisible  
Tijeras pizza, desmontables

art. cm.

18276-00 25



# JAPANESE SUSHI KNIVES

## COLTELLI SUSHI GIAPPONESI

KNIVES  
COLTELLERIA



Excellent choice when preparing sushi and vegetables. Molybdenum/ Vanadium s/s blades for excellent edge retention, razor sharp edges, slip resistant wooden handles. The blades are sharpened with the traditional Japanese single bevel to improve sharpness. The large beveled one-sided edge is much thinner than a two-sided edge. This thinner, sharper edge makes for cleaner cuts through the soft flesh of fish, in particular. Using these knives will avoid bruising the delicate texture of raw fish and destroying the freshness of the fish. The thinner edge is more fragile than the edge on western knives. Do not use for cutting anything solid including larger fish bones. Due to the special blade sharpening and s/s used we highly recommend to only hand wash and dry the blades thoroughly immediately.

Una scelta eccellente per la preparazione di sushi e verdure. Lame in acciaio inox, molibdeno e vanadio, per un'ottimale tenuta del filo, affilatura a rasoio, manici in legno antiscivolo. Secondo la tradizione giapponese l'affilatura è unilaterale ed il filo è molto più sottile rispetto a quello della normale affilatura dei coltelli occidentali. Questo rende i tagli più nitidi ed evita di creare traumi alla trama delicata di carne e pesce crudo. Non utilizzare per il taglio di solidi incluse grosse lisce di pesce. Data la particolarità dell'affilatura e dell'acciaio piegato si consiglia vivamente di lavare a mano ed asciugare immediatamente con cura le lame.



**DEBA**

art.	l. cm.
18280-22	22,5
18280-16	16,5
18280-10	10,5

**The Deba is a powerful knife used for filleting fish and butchering meat without bones. Its weight and thickness can chop through fish bones and the sharp edge can fillet even the smallest of fish.** – Affilato e dalla lama pesante usato per disossare e tagliare il pesce utilizzato nel sushi. È simile ad un coltello da chef.



**OROSHI**

art.	l. cm.
18281-24	24

**An Oroshi Knife is a Japanese all-purpose cooking knife, but used particularly for fish.** – Per sfilettare il tonno e altri pesci di grandi dimensioni.



**USUBA**

art.	l. cm.
18282-22	22,5
18282-18	18,0
18282-19*	18,0

**\*Double bevel. The Usuba is the ultimate vegetable knife. Sharp and thin, it is used by chefs in Japan for katsuramuki, a traditional style of peeling vegetables into thin sheets.** – \*Doppia affilatura. Coltello estremamente affilato con una punta quadrata. Questo coltello è usato per tagliare verdure e quando è tenuto ben affilato può tagliarle in fette sottili come un foglio di carta.



**TAKO SASHIMI**

art.	l. cm.
18283-33	33
18283-27	27

**The Tako Sashimi is a variation of the Yanagi and is used to slice straight-cut sashimi. The blunt tip and balanced weight works well on difficult ingredients like octopus, from which it gets its name. Originated in Kanto (Tokyo) region.** – Il coltello Tako Sashimi assomiglia di più ad un coltello occidentale ed è utilizzato per affettare tagli spessi di carne per sushi. Ha la lama senza punta, per evitare di rovinare i tentacoli del polpo.



**YANAGI SASHIMI**

art.	l. cm.
18284-21	21
18284-27	27
18284-30	30
18284-33	33

**The Yanagi Sashimi is a slicing knife used to cut boneless fish fillets into sashimi and topping for sushi. The graceful, thin blade cuts beautiful slices in one long, drawing stroke. Originated in Kansai (Osaka) region.** – Viene utilizzato per tagliare sottili fette di verdure, carne o pesce, nonché per tagliare in generale a dadi o a fette. Grazie alla sua lama sottile ed affilata è utilizzato anche per creare guarnizioni o tagliare i rotoli di sushi.





**Knife case, 14 pieces**  
Valigia cuoco, 14 pz.  
Messerkoffer, 14 Stk.  
Mallette de chef, 14 pièces  
Maleta cuchillos, 14 piezas

art.	des.
18099-15	Comprende/includes:
18000-26	cook's knife/cucina cm 26
18000-30	cook's knife/cucina cm 30
18002-18	butcher's knife/francese cm 18
18002-26	butcher's knife/francese cm 26
18009-30	ham/prosciutto cm 30
18016-16	boning/disosso cm 6
18024-11	paring/spelucchino cm 11
18026-07	paring/spelucchino cm 7
18028-30	bread/pane cm 30
18230-17	fork/forchettone cm 17
18235-30	sharpener/acciaino cm 30
18519-26	spatula/spatola cm 26
48280-34	peeler/pelapatate
18276-00	scissors/forbice pizza

**Knife case, 17 pcs**  
Valigia cuoco, 17 pz.  
Messerkoffer, 17 Stk.,  
Mallette de chef, 17 pcs  
Maleta cuchillos, 17 piezas

art.	des.
18199-19	Comprende/includes:
18100-24	cook's knife/cucina cm 24
18100-30	cook's knife/cucina cm 30
18112-30	salmon/salmone cm 30
18115-20	filleting/filettare cm 20
18116-14	boning/disosso cm 14
18125-10	paring/spelucchino cm 10
18126-07	bent paring/spelucchino cm 7
18128-30	bread/pane cm 30
18230-17	fork/forchettone cm 17
18235-30	sharpener/acciaino cm 30
18276-00	scissors/forbice pizza
18255-00	sharpener/affila coltelli
48280-25	apple corer/levatorsoli
48280-34	peeler/pelapatate
48280-02	can opener/apribottiglie
48280-27	melon baller/scavino
48280-92	striper/decora limoni





**Knife roll-bag, 9 pieces forged**  
Rotolo portacoltelli, 9 pz. forgiati  
Messer-Rolltasche, 9-teilig  
Rouleau pour couteaux, 9 pièces  
Estuche cuchillos, 9 piezas

art.	des.
18190-09	Comprende/includes:
18116-14	boning/disosso cm 9
18100-24	cook's/cucina cm 24
18106-25	slicer/affettare cm 25
18109-26	ham/prosciutto cm 24



art.	des.
18124-09	paring/spelucchino
18128-24	bread/pane cm 14
18230-17	fork/forchettone
18235-26	sharpener/acciaino
18271-00	scissors/forbice



**Knife block, 9 pcs set**  
Ceppo portacoltelli, set 9 pz  
Messerblock, 9-tlg.  
Bloc à couteaux, set 9 pièces  
Bloque portacuchillos, 9 piezas

art.	des.
18192-09	Comprende/includes:
18100-20	cook's/cucina cm 20
18106-20	slicer/affettare cm 20
18124-09	paring/spelucchino cm 9
18128-20	bread/pane cm 20



art.	des.
18230-17	fork/forchettone cm 17
18235-26	sharpener/acciaino cm 26
18271-00	scissors/forbice
18102-16	butcher's/francese cm 16
18126-07	paring/cuoco cm 7





**Magnetic knife rack**

Barra magnetica  
Magnet-Messerhalter  
Porte-couteaux magnetic  
Barra magnética portas cuchillos

art.	cm.
48032-30	30
48032-45	45
48032-60	60



SS

E<sup>dlund</sup>

**Knife block**

Ceppo porta coltelli  
Messerblock  
Bloc à couteaux  
Bloque portacuchillos

art.	cm.
49875-06	26x14x33



SS

E<sup>dlund</sup>

**Knife rack**

Porta coltelli  
Messeraufhänger  
Support à couteaux  
Porta cuchillos

art.	cm.
48040-00	30,5x6,6x30,5

**Holds 8 chef 's knives, 2 smaller knives, 1 steel and scissors.** – Per 8 coltelli cuoco, 2 coltelli piccoli, 1 acciaio e forbici.



SS

E<sup>dlund</sup>

**Knife rack**

Porta coltelli  
Messeraufhänger  
Support à couteaux  
Porta cuchillos

art.	cm.
48040-10	30,5x6,6x35,6

**Holds 8 chef 's knives, 2 smaller knives, 1 steel and scissors.** – Per 8 coltelli cuoco, 2 coltelli piccoli, 1 acciaio e forbici.



SS

E<sup>dlund</sup>

**Knife rack**

Porta coltelli  
Messeraufhänger  
Support à couteaux  
Porta cuchillos

art.	cm.
48039-06	15,2x6,6x30,5

**Holds 1 cleaver and 4 chef knives or 6 chef knives or 8 slicers or 12 paring knives and 1 round or diamond steel.** – Per 1 mannaia e 4 coltelli cuoco o 6 coltelli cuoco o 8 coltelli affettare o 12 spelucchini e 1 acciaio tondo.



SS

E<sup>dlund</sup>

**Knife sanitizing system**

Sterilizzatore ad immersione  
Messerkleimer  
Stérilisateur à couteaux  
Esterilizador a inmersión

art.	cm.
48040-50	45,7x11,5x45,7



**Manual sharpener**

Affilacoltelli manuale  
Messer Schleifapparat  
Affûteur manuel  
Afilador manual

art.
18255-00



**Manual sharpener**

Affilacoltelli manuale  
Messer Schleifapparat  
Affûteur manuel  
Afilador manual

art.
49739-00



**Salami pricker**

Pungisalame  
Salamistachel  
Pique saucisson  
Picadura para embutido

art.
42523-00



SS

**Larding needle with flap**

Ago lardellare con becco  
Spicknadel mit Klappe  
Lardoire à clapet  
Aguja para mechar

art.	Ø mm.	cm.
42514-20	5	20



SS

**Trussing needle straight**

Ago da cucina  
Dressiernadel  
Aiguille à brider droite  
Aguja para bridar

art.	cm.
42515-18	18
42515-20	20



SS

**Trussing needle bent**

Ago da cucina curvo  
Dressiernadel gebogen  
Aiguille à brider courbe  
Aguja curva para bridar

art.	cm.
42516-18	18
42516-20	20



SS

**Needles 5 pcs set**

Aghi set 5 pz  
Nadelsatz, 5 Stk.  
Aiguilles set 5 pcs  
Agujas 5 pz

art.
42517-06



W

**Skewers, 100 pcs**

Spiedini, 100 pz  
Fleischspieße, 100 Stk  
Brochettes, 100 pcs  
Palos para asar, 100 pz

art.	cm.
48307-01	15
48307-02	20
48307-03	25



SS

**Skewers 6 pcs set**

Spiedini set 6 pz  
Fleischspieße, Satz 6 Stk  
Brochettes set 6 pcs  
Palos para asar 6 pz

art.	cm.
42529-06	30



**Skewers falt, 18/8**

Spiedini piatti, 18/8  
Fleischspieße, flach, 18/8  
Brochettes plates, 18/8  
Pinchos planos, 18/8

art.	mm.	U. Pack
42511-20	200x3	10
42511-25	250x3	10
42511-30	300x3	10
42511-35	350x3	10
42511-40	400x3	10
42511-56	560x5	10



**Swords, 18/8**

Spade, 18/8  
Schwerver, 18/8  
Espées, 18/8  
Espadas, 18/8

art.	mm.
42511-60	600x15x3
42511-70	700x15x3



SS

**Anchor meat hook**

Gancio ad ancora  
Anker Fleischhaken  
Esse à ancre  
Gancho forma ancla

art.	Ø mm.	cm.	U. Pack
42507-12	7	13	10





SS

**Sliving meat hook**

Gancio girevole  
Fleischdrehhaken  
Esse-tournante  
Gancho giratorio

art.	Ø mm.	cm.	U. Pack
42525-27	12	27	10



SS

**Meat hook, 2 peacks**

Gancio fisso, 2 punte  
Fleischhaken, 2 Spitze  
Crochet esse, 2 pointes  
Gancho 2 puntas

art.	Ø mm.	cm.	U. Pack
42524-06	3	6	10
42524-08	4	8	10
42524-10	4	10	10
42524-12	5	12	10
42524-14	5	14	10
42524-16	6	16	10
42524-18	6	18	10
42524-20	9	20	10
42524-22	9	22	10
42524-30	12	30	10



SS

**Meat hook, 1 peack**

Gancio fisso, 1 punta  
Fleischhaken, 1 Spitze  
Crochet esse, 1 pointe  
Gancho 1 punta

art.	Ø mm.	cm.	U. Pack
42506-08	3	8	10
42506-10	4	10	10
42506-12	5	12	10
42506-14	5	14	10
42506-16	6	16	10
42506-18	6	18	10



SS

**Swivel meat hook**

Gancio girevole  
Fleischdrehhaken  
Esse-tournante  
Gancho giratorio

art.	Ø mm.	cm.
42505-21	9	22
42505-24	10	24
42505-27	12	27
42505-50	12	50



SS

**Sliding meat hook**

Gancio scorrevole  
Fleischhaken  
Crochet coulissant  
Gancho

art.	Ø mm.	cm.	U. Pack
42526-12	9	12	10
42526-14	12	14	10



SS

**Ham tongs**

Pinza per affettati  
Schinkenzange  
Pince à jambon  
Pinza para jamón

art.	cm.
42510-00	11x6



SS

**Meat tenderizer**

Batticarne a pugno  
Kotelettklopfen  
Aplatisseur  
Aplasta carnes

art.	Kg.
42501-15	1,5
42501-20	2,0



SS

**Meat tenderizer**

Batticarne a due tagli  
Kotelettklopfen  
Aplatisseur  
Aplasta carnes

art.	Kg.
42502-11	1,1



SS

**Meat tenderizer**

Batticarne a paletta  
Kotelettklopfen  
Aplatisseur  
Aplasta carnes

art.	Kg.
42503-10	1



**Steak hammer, aluminum**

Batticarne, alluminio  
Aluminum-Fleischklopfer  
Attendrisseur, alu  
Aplasta carnes, aluminio

art.	cm.	Kg.
42508-00	32	0,6



**Steak hammer, aluminum**

Batticarne, alluminio  
Aluminum-Fleischklopfer  
Attendrisseur, alu  
Aplasta carnes, aluminio

art.	cm.	Kg.
42508-01	25	0,41



SS

**Bone-saw**

Sega per ossa  
Knochensäge  
Scie à os  
Sierra de cocina

art.	cm.
48231-40	40
48231-45	45
48231-50	50



SS

**String holder**

Portaspago  
Schnurrolle-Halter  
Porte rolls sur socle  
Porta cuerda

art.	cm.
42579-00	19x12x17



SS

**Meat pan**

Vassoio rettangolare  
Fleischblech  
Plat boucher  
Bandeja rectangular

art.	cm.
42534-26	26x23x2
42534-32	34x21x2
42534-41	45x25x2



SS

**Display tray**

Vassoio espositore  
Ausstellplatte  
Plateau  
Bandeja expositora

art.	cm.
42532-29	29x21x2
42532-58	58x21x2



SS

**Meat pan**

Vassoio  
Fleischblech  
Plat boucher  
Contenedor

art.	cm.
42530-26	24,4x21,6x5,5
42530-32	32x23x5,5
42530-41	41x31x5,5
42530-50	50x35x5,5



SS

**Meat pan with grid**

Vassoio con griglia  
Fleischblech mit Siebeinsatz  
Plat boucher avec grille  
Contenedor con rejilla

art.	cm.
42531-26	24,4x21,6x5,5
42531-32	32x23x5,5
42531-41	41x31x5,5
42531-50	50x35x5,5



**Ham stand on wood**

Ferma prosciutto base legno  
Schinkenhalter, Holzsockel  
Pince à jambon sur bois  
Jamonero, base madera

art.	cm.	Kg.
41582-00	24x45x16	4,5



**Ham stand on marble**

Ferma prosciutto base marmo  
Schinkenhalter, Marmorsockel  
Pince à jambon sur marbre  
Jamoneiro, base mármol

art.	cm.	Kg.
41583-00	24x45x15	10,3



SS

**Hamburger press**

Pressa-hamburger  
Hamburgerpresse  
Moule à steak  
Prensa para hamburguesa

art.	Ø cm.	l. cm.
42864-10	10	36



**Hamburger press, anodized aluminum**

Pressa-hamburger, alluminio anodizzato  
Hamburgerpresse, Aluminium eloxiert  
Moule à steak, aluminium anodisé  
Prensa para hamburguesa, aluminio anodizado

art.	cm.	Kg.
49978-10	37x25x50	5,0
49978-13	42x27,5x53	5,5

**The parts coming into contact with food are in stainless steel. – Parti a contatto con il cibo in acciaio inox per alimenti.**



**Vertical manual sausage filler**

Insacatrice verticale  
Wurstfüller  
Poussoir manuel vertical  
Enscadora vertical

art.	cm.	lt.	Kg.
49876-03	30x22x47,5	3	6,2

**With 3 funnels. – Con 3 imbuti.**



**Manual slicing machine - Flywheel**

Affettatrice manuale - Volano  
Aufschnittmaschine - Schwungrad  
Trancheuse manuelle - Volant  
Cortadora manual - Volante

art.	Ø cm.	cm.	Kg.
49971-25	25	68x52x51	33

**Cut thickness range mm 0÷2,3. 9 cutting positions. Cut cm 18,5x51. – Spessore taglio mm. 0÷2,3. 8 scatti. Taglio utile cm 18,5x15.**



**Manual slicing machine - Flywheel**

Affettatrice manuale - Volano  
Aufschnittmaschine - Schwungrad  
Trancheuse manuelle - Volant  
Cortadora manual - Volante

art.	Ø cm.	cm.	Kg.
49972-30	30	72x60x74	45,5

**Cut thickness range mm 0÷2,5. 9 cutting positions. Cut cm 23x19. – Spessore taglio mm. 0÷2,5. 9 scatti. Taglio utile cm 23x19.**



**Manual slicing machine - Flywheel**

Affettatrice manuale - Volano  
Aufschnittmaschine - Schwungrad  
Trancheuse manuelle - Volant  
Cortadora manual - Volante

art.	Ø cm.	des.
49971R25	25	Rose
49971M25	25	Daisy
49972R30	30	Rose
49972M30	30	Daisy



**Stand**

Piedistallo  
Sockel  
Piédestal  
Pedestal

art.	cm.
49971P25	65x80
49972P30	65x80



**Stand with wheels**

Piedistallo con ruote  
Sockel mit Rädern  
Piédestal avec roues  
Pedestal con ruedas

art.	cm.
49971R00	65x80



**Block brush, plastic handle**  
Spazzola per ceppa  
Blockbürste, Kunststoffgriff  
Brosse à billot, matière plastique  
Cepillo para cepa

art. cm.  
42518-01 20



**Cutting board with tray**  
Tagliere con vasca  
Tranchierbrett mit Tablett  
Planche à découper avec plateau  
Tabla de corte con bandeja

art. cm.  
44947-00 33,5x46x5,5



**Cutting board**  
Tagliere bar  
Tranchierbrett  
Planche à découper  
Tabla de corte

art. cm.  
42521-16 16x24,5x1  
42521-24 24,5x32,5x1



**03 = RED / ROSSO**  
Raw meat and poultry  
Carni crude  
Rohes Fleisch  
Viande crue  
Carne cruda



**02 = BROWN / MARRONE**  
Raw vegetables  
Verdure crude  
Rohes Gemüse  
Crudités  
Verduras crudas



**04 = BLUE / BLU**  
Raw fish  
Pesce  
Fisch  
Poisson  
Pescado



**01 = YELLOW / GIALLO**  
Cooked meats  
Carni cotte  
Gekochtes Fleisch  
Viande cuite  
Carne cocida



**05 = GREEN / VERDE**  
Salads and fruits  
Insalata e frutta  
Salat und Früchte  
Salade et fruits  
Ensalada y fruta



**00 = WHITE / BIANCO**  
Bakery and dairy products  
Pane e formaggi  
Brot und Käse  
Pain et fromages  
Pan y quesos



**07 = VIOLA / VIOLET**  
Gluten Free  
Casher  
Halal  
Vegan



HDPE

**Cutting board**  
Tagliere bar  
Tranchierbrett  
Planche à découper  
Tabla de corte

art.	cm.	GN	col.
42522-00	32x26,5x2	1/2	○
42522-01	32x26,5x2	1/2	●
42522-02	32x26,5x2	1/2	●
42522-03	32x26,5x2	1/2	●
42522-04	32x26,5x2	1/2	●
42522-05	32x26,5x2	1/2	●
42522-09	32x26,5x2	1/2	●



HDPE

**Cutting board**  
Tagliere bar  
Tranchierbrett  
Planche à découper  
Tabla de corte

art.	cm.	GN	col.
42538-00	53x32,5x2	1/1	○
42538-01	53x32,5x2	1/1	●
42538-02	53x32,5x2	1/1	●
42538-03	53x32,5x2	1/1	●
42538-04	53x32,5x2	1/1	●
42538-05	53x32,5x2	1/1	●
42538-09	53x32,5x2	1/1	●



HDPE

**Cutting board**  
Tagliere bar  
Tranchierbrett  
Planche à découper  
Tabla de corte

art.	cm.	col.
42539-00	60x40x2	○
42539-01	60x40x2	●
42539-02	60x40x2	●
42539-03	60x40x2	●
42539-04	60x40x2	●
42539-05	60x40x2	●
42539-09	60x40x2	●



HDPE

**Cutting board**  
Tagliere bar  
Tranchierbrett  
Planche à découper  
Tabla de corte

art.	cm.
42522-07	32x26,5x2
42538-07	53x32,5x2
42539-07	60x40x2



HDPE

**Cutting board**  
Tagliere bar  
Tranchierbrett  
Planche à découper  
Tabla de corte

art.	cm.
42537-40	40x30x2
42537-50	50x30x2
42537-80	80x40x2



HDPE

**Cutting board with groove**  
Tagliere con canalina  
Tranchierbrett mit Kanal  
Planche à découper avec rigole  
Tabla de corte con ranura

art.	cm.	GN	col.
42546-00	65x53x2	2/1	○
42546-01	65x53x2	2/1	●
42546-02	65x53x2	2/1	●
42546-03	65x53x2	2/1	●
42546-04	65x53x2	2/1	●
42546-05	65x53x2	2/1	●





HDPE

**Cutting board with stoppers**

Tagliere con fermi  
Tranchierbrett mit Stiften  
Planche à découper avec arrêts  
Tabla de corte con barras de la parada

art.	cm.	GN	col.
42543-00	53x32,5x2	1/1	○
42543-01	53x32,5x2	1/1	●
42543-02	53x32,5x2	1/1	●
42543-03	53x32,5x2	1/1	●
42543-04	53x32,5x2	1/1	●
42543-05	53x32,5x2	1/1	●



HDPE

**Cutting board with stoppers**

Tagliere con fermi  
Tranchierbrett mit Stiften  
Planche à découper avec arrêts  
Tabla de corte con barras de la parada

art.	cm.	col.
42544-00	60x40x2	○
42544-01	60x40x2	●
42544-02	60x40x2	●
42544-03	60x40x2	●
42544-04	60x40x2	●
42544-05	60x40x2	●



HDPE

**Cutting board with stoppers**

Tagliere con fermi  
Tranchierbrett mit Stiften  
Planche à découper avec arrêts  
Tabla de corte con barras de la parada

art.	cm.
42540-40	40x30x2
42540-50	50x30x2
42540-80	80x40x2



HDPE

**Colored cutting boards set 6 pcs**

Taglieri colorati set 6 pz  
Tranchierbretter 6 Stk.  
Planches à découper set 6 pcs  
Juego 6 tablas de corte

art.	cm.
42541-06	46x31x1,3



HDPE

**Round cutting board**

Tagliere tondo  
Tranchierbrett, rund  
Planche à découper, ronde  
Tabla de corte redonda

art.	Ø cm.	h. cm.
42535-24	24,0	1,0
42535-32	32,5	1,5
42535-49	49,0	1,5



HDPE

**Butchers table**

Ceppa  
Hackblock  
Billot  
Cepa

art.	cm.	mm.
42518-50	50x50x86	4*

\*Thickness. – Spessore.



HDPE

**Worktop**  
Ceppo  
Arbeitsplatte  
Plan de travail  
Encimera

art. cm. mm.  
42519-01 50x50 4\*

\*Thickness. – Spessore.



HDPE

**Board scraper**  
Raschietto  
Blockschäber  
Racloir à planches  
Rascador

art. cm.  
42520-00 17x6x9

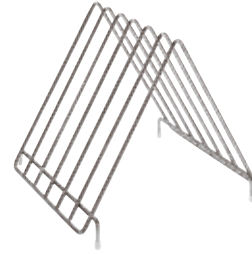

SS

**Cutting board rack**  
Portataglieri in filo  
Tranchierbretter-Träger  
Sechoir à plaches à découper  
Porta tablas

art. cm.  
42542-00 30x26x27,5



W

**Bread cutting board**  
Tagliere pane  
Brotschneidbrett  
Planche à découper  
Tabla de corte

art. cm.  
42964-53 53x32,5x2  
42964-60 60x40x2



CE  
SS

**Chainmail glove**  
Guanto in cotta di maglia  
Fingerhandschuhe  
Gant en cotte de mailles  
Guante de malla

art. size/T. col.  
48505-01 Small ○  
48505-02 Medium ●  
48505-03 Large ●

**UNI EN 1082-1:1998. Fits either hands, rings ø 4 mm. Thickness ø 0,5 mm. nylon strap.**  
Ambidestro, anelli ø 4 mm. Spessore ø 0,5 mm. cinturino nylon.



CE  
SS

**Chainmail glove, extended cuff**  
Guanto lungo in cotta di maglia  
Fingerhandschuhe, lang  
Gant en cotte de mailles, manchette longue  
Guante largo de malla

art. size/T. col.  
48506-01 Small ○  
48506-02 Medium ●  
48506-03 Large ●

**UNI EN 1082-1:1998. Fits either hands, rings ø 4 mm. Thickness ø 0,5 mm. nylon strap.**  
Ambidestro, anelli ø 4 mm. Spessore ø 0,5 mm. cinturino nylon.



CE  
SS

**Protective apron**  
Grembiule di protezione  
Schutzschürze  
Tablier de protection  
Delantal de protección

art. cm.  
48501-76 75x55

**UNI EN 1082-1:1998. Belt fastening with textile adjustable and detachable straps. – Dotato di bretelle regolabili e staccabili.**



**Oven mitt**  
Guanto da forno  
Ofenhandschuh  
Moufle de déformement  
Manopla de protección

art. l. cm.  
48510-00 28

**Outer fabric 100% cotton with silver coating, 100 g/mq. – Tessuto esterno 100% cotone con rivestimento argenteo 100 g/mq.**



**Oven mitt, silicone**  
Guanto da forno, silicone  
Backhandschuhe, Silikon  
Gant de protection, silicone  
Manopla de protección, silicona

art.  
48514-00

**Ambidextrous. Contact heat resistant up to +300°C for 15 seconds. Non-slip, water and oil tight, dishwasher safe. – Ambidestro. Resistenza al calore per contatto fino a 300°C per 15 secondi. Stagno all'acqua e agli oli bollenti, lavabile in lavastoviglie.**



**Cut resistant glove**

Guanto anti taglio  
Schnittschutz-Handschuh  
Gant anti-coupures  
Guante de protección

art. size/T.

48523-01 S  
48523-02 M  
48523-03 L  
48523-04 XL

**Spectra fiber glove, cut resistance std EN388: level 5, washable up to 90°C, ambidextrous. Supplied with cotton underglove.** – Guanto in fibra spectra, resistenza al taglio std EN388: livello 5, lavabile fino a 90°C, ambidestro. Fornito con sottoguanto in cotone.



**Three-finger oven glove**

Guanti anticalore a 3 dita  
Backhandschuhe, 3 Finger  
Moufles protection thermique, 3 doigts  
Guantes de protección

art. l. cm.

48517-03 35,5

**Resistant to abrasion, tears and cuts. CE marking, in accordance to the basic requirements concerning health and security of the European Directives 89/686/C.E.E. Contact heat resistant up to +350°C for 20 seconds.** – Resistenti all'abrasione, agli strappi ed ai tagli. Marcati CE, rispettano i requisiti essenziali di salute e sicurezza secondo le direttive europee 89/686/C.E.E. Hanno una resistenza al calore per contatto fino a 350°C per 20 secondi.



**Oven mitts**

Guanti da forno  
Backhandschuhe  
Moufles de défournement  
Manoplas de protección

art. cm.

48511-02 34x16

**Special cotton fabric, natural color, reinforced palm and thumb. Heat resistant up to +200°C. Machine washable up to +40°C.** – In cotone speciale, colore naturale, esecuzione rinforzata palmo e pollice. Resistente fino a +200°C. Lavabile in lavatrice max. 40°C.



**Oven mitts**

Guanti da forno  
Backhandschuhe  
Moufles de défournement  
Manoplas de protección

art. cm.

48513-02 26x14,5

**Special cotton fabric, natural color, reinforced palm and thumb. Heat resistant up to +200°C. Machine washable up to +40°C.** – In cotone speciale, colore naturale, esecuzione rinforzata palmo e pollice. Resistente fino a +200°C. Lavabile in lavatrice max. 40°C.



**Oven mitts**

Guanti da forno  
Backhandschuhe  
Moufles de défournement  
Manoplas de protección

art. cm.

48512-02 27x15

**Special cotton fabric, natural color, reinforced palm and thumb. Heat resistant up to +200°C. Machine washable up to +40°C.** – In cotone speciale, colore naturale, esecuzione rinforzata palmo e pollice. Resistente fino a +200°C. Lavabile in lavatrice max. 40°C.



**Sugar gloves**

Guanti in lattice  
Zucker-Handschuhe  
Gants à tirer le sucre  
Guantes de látex

art. size/T.

48516-07 7 – 7 1/2

48516-08 8 – 8 1/2

48516-09 9 – 9 1/2



**Scrubbing gloves**

Guanti scrub  
Schrubben Handschuhe  
Gants à scrubbing  
Guantes para fregar

art. size/T.

48518-01 one size



**Scrubbing gloves**

Guanti scrub  
Schrubben Handschuhe  
Gants à scrubbing  
Guantes para fregar

art. size/T.

48518-02 one size



# PASTRY PASTICCERIA

EQUIPMENT  
ATTREZZATURE







**Alphabet pcs 26**

Alfabeto pz 26

art.	Ø cm.	h. cm.
47301-12	12	2



**Numbers pcs 10**

Numeri pz 10

art.	Ø cm.	h. cm.
47302-10	10	2



**Animals pcs 10**

Animali pz 10

art.	Ø cm.	h. cm.
47303-10	10	2

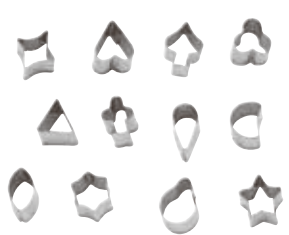

**Shapes pcs 12**

Sagome pz 12

art.	Ø cm.	h. cm.
47304-06	6,5	2

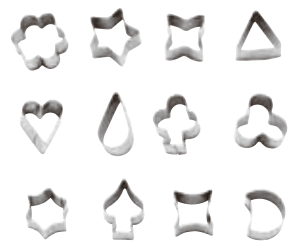

**Shapes pcs 12**

Sagome pz 12

art.	Ø cm.	h. cm.
47304-10	10	2



**Shapes pcs 12**

Sagome pz 12

art.	Ø cm.	h. cm.
47304-12	12	2



**Shapes pcs 12**

Sagome pz 12

art.	Ø cm.	h. cm.
47305-12	12	2



**Flower pcs 6**

Fiore pz 6

art.	Ø cm.	h. cm.
47306-10	10	3

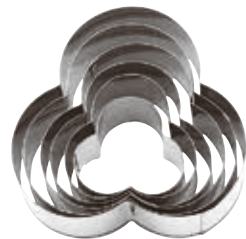

**Trio pcs 6**

Trio pz 6

art.	Ø cm.	h. cm.
47307-10	10	3



**Heart pcs 6**

Cuore pz 6

art.	Ø cm.	h. cm.
47308-10	10	3



**Star pcs 6**

Stella pz 6

art.	Ø cm.	h. cm.
47310-10	10	3



**Halfmoon pcs 6**

Mezzaluna pz 6

art.	Ø cm.	h. cm.
47312-10	10	3

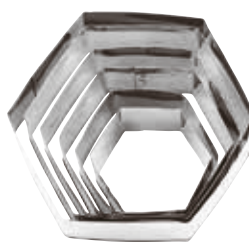

**Hexagon pcs 6**

Esagono pz 6

art.	Ø cm.	h. cm.
47314-10	10	3

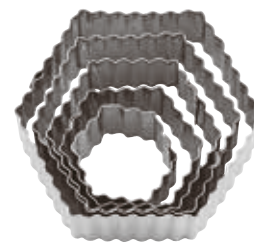

**Hexagon, fluted pcs 5**

Esagono festonato pz 5

art.	Ø cm.	h. cm.
47315-10	10	3,5

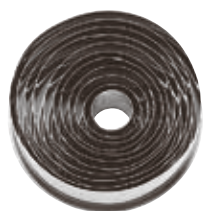

**Ring pcs 11**

Anello pz 11

art.	Ø cm.	h. cm.
47316-10	10	3



**Ring pcs 14**

Anello pz 14

art.	Ø cm.	h. cm.
47316-12	12	3



**Ring pcs 20**

Anello pz 20

art.	Ø cm.	h. cm.
47316-20	20	2,5



**Ring, fluted pcs 11**

Anello festonato pz 11

art.	Ø cm.	h. cm.
47317-10	10	3





**Ring, fluted pcs 14**  
Anello festonato pz 14

art.	Ø cm.	h. cm.
47317-12	12	3



**Drop pcs 6**  
Goccia pz 6

art.	Ø cm.	h. cm.
47321-12	12	3



**Drop, fluted pcs 5**  
Goccia festonata pz 5

art.	Ø cm.	h. cm.
47322-12	12,5	3,5



**Square pcs 6**  
Quadro pz 6

art.	Ø cm.	h. cm.
47323-12	12	3

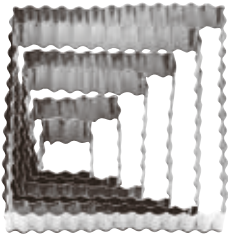

**Square, fluted pcs 6**  
Quadro festonato pz 6

art.	Ø cm.	h. cm.
47324-12	12,5	3,5



**Oval pcs 9**  
Ovale pz 9

art.	Ø cm.	h. cm.
47326-10	10	3,5

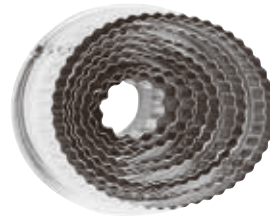

**Oval, fluted pcs 9**  
Ovale festonato pz 9

art.	Ø cm.	h. cm.
47325-10	10	3,5



**Fruit pcs 12**  
Frutta pz 12

art.	Ø cm.	h. cm.
47327-12	12,5	2



**Animals pcs 10**  
Animali pz 10

art.	Ø cm.	h. cm.
47328-15	15	2



**Vehicles pcs 7**  
Veicoli pz 7

art.	Ø cm.	h. cm.
47331-15	15	2



**Vegetable pcs 12**  
Verdura pz 12

art.	Ø cm.	h. cm.
47332-12	12,5	2



**Christmas pcs 7**  
Natale pz 7

art.	Ø cm.	h. cm.
47333-15	15	2



**Easter pcs 6**  
Pasqua pz 6

art.	Ø cm.	h. cm.
47334-12	12,5	2

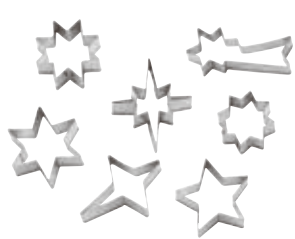

**Stars pcs 7**  
Stelle pz 7

art.	Ø cm.	h. cm.
47335-12	12,5	2



**Shapes pcs 10**  
Sagome pz 10

art.	Ø cm.	h. cm.
47419-10	20	3,5



**Shapes pcs 42**  
Sagome pz 42

art.	Ø cm.
47336-42	6>22



**Plain ring pcs 3**  
Anello liscio pz 3

art.	Ø cm.	h. cm.
47414-03	6-7-8	3



**Fluted ring pcs 3**  
Anello festonato pz 3

art.	Ø cm.	h. cm.
47415-03	6-7-8	3



**Canestrello**  
Canestrello

art.	Ø cm.	h. cm.
47416-06	6	3



**Canestrello, fluted**  
Canestrello festonato

art.	Ø cm.	h. cm.
47417-06	6	3

CHRISTMAS  
NATALE



**Gingerbread man**  
Omino pan di zenzero  
art. cm.  
47370-08 6x8x3



**Angel**  
Angelo  
art. cm.  
47377-08 7x7x3



**Snowman**  
Pupazzo di neve  
art. cm.  
47378-08 4x8x3



**Reindeer**  
Renna  
art. cm.  
47379-08 8x7x3



**Star**  
Stella  
art. cm.  
47411-08 8x8x3

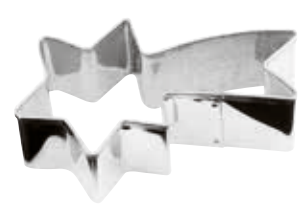

**Comet**  
Stella cometa  
art. cm.  
47412-08 8x4x3



**Christmas tree**  
Albero di Natale  
art. cm.  
47413-08 8x8x3



**Pine**  
Pino  
art. cm.  
47413-01 6,4x8x3



**Snowflake**  
Fiocco di neve  
art. cm.  
47411-01 7,4x8,6x3



**Snowflake**  
Fiocco di neve  
art. cm.  
47411-02 7x8x3







**Snowflake**  
Fiocco di neve

art. cm.  
47411-03 8,5x8x3



**Christmas, set of 6 pcs.**  
Natale set 6 pz

art. cm.  
47387-01 8x8x3



**EASTER**  
PASQUA



**Rabbit**  
Coniglio

art. cm.  
47372-08 8x4x3



**Rabbit**  
Coniglio

art. cm.  
47402-08 8x5x3



**Rabbit**  
Coniglio

art. cm.  
47402-01 7x8,5x3



**Rabbit**  
Coniglio

art. cm.  
47402-02 7,5x7x3



**Bell**  
Campana

art. cm.  
47373-08 6x7x3



**Lamb**  
Agnellino

art. cm.  
47376-08 8x7x3





**Dove**

Colomba

art. cm.

47382-08 8x7x3



**Egg**

Uovo

art. cm.

47373-01 5,6x8x3



**Easter, set of 5 pcs.**

Pasqua set 5 pz

art. cm.

47387-02 8x8x3



## HALLOWEEN



**Skeleton**

Scheletro

art. cm.

47370-08 6x8x3

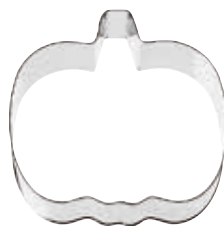

**Pumpkin**

Zucca

art. cm.

47377-09 9x8x3



**Pumpkin**

Zucca

art. cm.

47377-10 8x8x3



**Ghost**

Fantasma

art. cm.

47377-03 8x8,4x3



**Owl**

Gufo

art. cm.

47377-02 4,7x8,3x3





**Crescent**  
Mezzaluna

art. cm.  
47377-01 6,2x8x3



**Witch**  
Strega

art. cm.  
47377-04 9x9,5x3



**Witch hat**  
Cappello strega

art. cm.  
47377-05 8,5x13x3



**Witch on broom**  
Strega su scopa

art. cm.  
47377-06 11,6x12x3



**Skull**  
Teschio

art. cm.  
47377-07 8x8x3



**Halloween, set of 3 pcs.**  
Halloween set 3 pz

art. cm.  
47377-11 11x10,7x2



**ANIMALS & VARIOUS**  
ANIMALI & VARI



**Honey bee**  
Ape

art. cm.  
47382-06 11,6x8x3

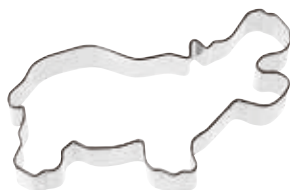

**Hippo**  
Ippopotamo

art. cm.  
47404-04 11x7x3



**Butterfly**  
Farfalla

art. cm.  
47371-08 8x7x3







**Snail**  
Lumaca  
art. cm.  
47404-02 11x6x3



**Fish**  
Pesce  
art. cm.  
47384-08 8x8x3



**Frog**  
Rana  
art. cm.  
47380-08 8x8x3



**Rooster**  
Gallo  
art. cm.  
47383-08 8x8x3



**Dolphin**  
Delfino  
art. cm.  
47384-01 5x9x3



**Seagull**  
Gabbiano  
art. cm.  
47386-08 11x6x3



**Cat**  
Gatto  
art. cm.  
47401-08 8x8x3



**Goose**  
Oca  
art. cm.  
47404-08 8x7x3



**Teddy bear**  
Orsetto  
art. cm.  
47375-08 8x8x3



**Camel**  
Cammello  
art. cm.  
47404-01 9x8,6x3



**Teddy bear**  
Orsetto  
art. cm.  
47375-01 6x9x3



**Elephant**  
Elefante  
art. cm.  
47404-03 12x7x3



**Four leaf clover**  
Quadrifoglio  
art. cm.  
47374-08 8x8X3



**Flower**  
Fiore  
art. cm.  
47374-02 7x7,4x3



**Tulip**  
Tulipano  
art. cm.  
47374-01 5,5x8x3





**Heart**

Cuore

art. cm.  
47385-08 8x9x3



**Two hearts**

Due cuori

art. cm.  
47385-01 9,4x5x3



**Rocking horse**

Cavallo a dondolo

art. cm.  
47381-08 8x5x3



**Bow**

Fiocco

art. cm.  
47373-02 6x8x3



**Apple**

Mela

art. cm.  
47378-01 7,6x8,4x3



**Airplane**

Aereo

art. cm.  
47370-02 9x8x3



**Suits of cards, set of 4 pcs**

Semi carte set 4 pz

art. cm.  
47378-02 7,5x7,5x3



**Numbers, set of 9 pcs**

Numeri, set 9 pz

art. cm.  
47421-09 6,5x2,5

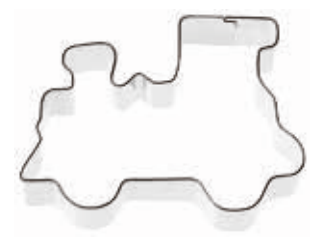

**Train**

Locomotiva

art. cm.  
47370-01 10x7x3



**Pirate ship**

Nave pirata

art. cm.  
47370-03 8x8,4x3



**Letters, set of 26 pcs**

Lettere, set 26 pz

art. cm.  
47422-26 6x2,5







**Round, set 6 pcs**  
Cerchio, set 6 pz

art.	cm.
47425-01	4x3
47425-02	5x3
47425-03	6x3



**Square, set 6 pcs**  
Quadro, set 6 pz

art.	cm.
47425-04	5x5x3
47425-05	6x6x3



**Triangle, set 6 pcs**  
Triangolo, set 6 pz

art.	cm.
47425-06	6x3



**Oval, set 6 pcs**  
Ovale, set 6 pz

art.	cm.
47425-09	7,5x4,5x3



**Trapeze, set 6 pcs**  
Trapezio, set 6 pz

art.	cm.
47425-08	9x6x3



**Rectangle, set 6 pcs**  
Rettangolo, set 6 pz

art.	cm.
47425-10	5x3,5x3
47425-11	6x5x3



**Drop, set 6 pcs**  
Goccia, set 6 pz

art.	cm.
47425-26	9x3



**Hexagon, set 6 pcs**  
Esagono, set 6 pz

art.	cm.
47425-29	5x3
47425-30	6x3



**Heart, set 6 pcs**  
Cuore, set 6 pz

art.	cm.
47425-32	6,5x3



**Square, set 6 pcs**  
Quadro, set 6 pz

art.	cm.
47426-01	8x8x4,5



**Rectangle**  
Rettangolo

art.	cm.
47426-07	12x6x4,5



**Doughnut cutter**  
Tagliapasta per doughnuts  
Donut-Ausstecher  
Coupe-donuts  
Cortadonuts

art.	Ø cm.	h. cm.
47388-06	65-25	20
47388-07	70-30	17
47388-08	80-40	20



**Cinnamon star cutter**  
Tagliapaste stelle  
Zimtstern-Ausstecher  
Coupe-étoiles  
Cortapasta Esterella

art.	cm.
47377-15	5x9,7

**Spring mechanism. – Meccanismo a molla.**



**Horseshoe, tin plate**  
Ferro di cavallo, banda stagnata  
Hufeisen, Weißblech  
Fer à cheval, fer blanc  
Herradura, hojalata

art.	cm.
47377-12	7x6x2



**CUTTERS  
TAGLIAPASTA**



**Round fluted cutter, set 6 pcs**  
Tagliapasta rotondo festonato, set 6 pz  
Ausstecher, rund, gewellt, 6 Stk  
Découpoir rond cannelé, 6 pcs  
Cortapasta redondo acanalado, 6 pz

art.	Ø cm.	h. cm.
12944-13	3>12	3,5



**Oval fluted cutter, set 6 pcs**  
Tagliapasta ovale festonato, set 6 pz  
Ausstecher, oval, gewellt, 6 Stk  
Découpoir ovale cannelé, 6 pcs  
Cortapasta ovalado acanalado, 6 pz

art.	Ø cm.	h. cm.
12947-13	5,5>13	3,5



**Round cutter**  
Tagliapasta rotondo  
Ausstecher, rund  
Découpoir rond  
Cortadores, 3 pz

art.	Ø cm.	h. cm.
12943-03	3	3,5
12943-05	5	3,5
12943-10	10	3,5
12943-12	12	3,5



**Round fluted cutter**  
Tagliapasta rotondo festonato  
Ausstecher, rund, gewellt  
Découpoir rond cannelé  
Cortapasta redondo acanalado

art.	Ø cm.	h. cm.
12944-03	3	3,5
12944-05	5	3,5
12944-07	7	3,5
12944-10	10	3,5



**Oval fluted cutter**  
Tagliapasta ovale festonato  
Ausstecher, oval, gewellt  
Découpoir ovale cannelé  
Cortapasta ovalado acanalado

art.	Ø cm.	h. cm.
12947-02	5,5x3,5	3,5
12947-03	7x4	3,5
12947-04	8,5x5	3,5
12947-05	10x6	3,5
12947-06	11x7	3,5
12947-07	13x5	3,5



**Dough plunger cutters w/extractor, 3 pcs**  
Tagliapasta con espulsore, set 3 pz  
Ausstechformen mit Auswerfer, 3 Stk  
Emportes-pièces, 3 pcs  
Cortadores, 3 pz

art.	Ø cm.
47622-04	3>4,5

**Holly.** – Agrifoglio.



**Dough plunger cutters w/extractor, 4 pcs**  
Tagliapasta con espulsore, set 4 pz  
Ausstechformen mit Auswerfer, 4 Stk  
Emportes-pièces, 4 pcs  
Cortadores, 4 pz

art.	Ø cm.
47622-26	1,2 - 2 - 2,8 - 3,5

**Daisy.** – Margherita.



**Dough plunger cutters w/extractor, 3 pcs**

Tagliapasta con espulsore, set 3 pz  
Ausstechformen mit Auswerfer, 3 Stk  
Emportes-pièces, 3 pcs  
Cortadores, 3 pz

art. Ø cm.

47622-01 3:5

**Petunie. – Petunia.**



**Dough plunger cutters w/extractor, 3 pcs**

Tagliapasta con espulsore, set 3 pz  
Ausstechformen mit Auswerfer, 3 Stk  
Emportes-pièces, 3 pcs  
Cortadores, 3 pz

art. Ø cm.

47622-02 2,5

**Flower. – Fiore.**



**Dough plunger cutters w/extractor, 3 pcs**

Tagliapasta con espulsore, set 3 pz  
Ausstechformen mit Auswerfer, 3 Stk  
Emportes-pièces, 3 pcs  
Cortadores, 3 pz

art. Ø cm.

47622-03 3:5

**Rose leaf. – Foglia di rosa.**



**SS**

**Set of 9 cutters**

Set 9 tagliapasta  
Satz 9 Ausstechformen  
Set 9 découpoirs  
Juego 9 cortadores

art. h. cm.

47837-09 0,5



**PA**

**Almond past knife**

Coltello per marzapane  
Marzipan-Messer  
Couteau à pâte d'amande  
Cuchillo para fondant/mazapán

art. l. cm.

47630-28 16,5



**PP**

**Marzipan set, 15 pcs**

Set 15 pezzi per marzapane  
Marzipan-Satz, 15 Stk.  
Set 15 outils à pâte d'amandes  
Set de 15 herramientas para decorar galletas

art.

47631-12



**PP**

**Marzipan set, 8 pcs**

Set 8 pezzi per marzapane  
Marzipan-Satz, 8 Stk.  
Set 8 outils à pâte d'amandes  
Set de 8 herramientas para decorar galletas

art.

47631-08



**SS**

**Set of 10 pcs dipping forks**

Set 10 forchettine pralineria  
Pralinen Gabelchen, 10 Stk.  
Jeu de 10 ébauchoirs  
Set de 10 herramientas para decorar chocolates

art.

47833-10



**SS**

**Set of 4 pcs dipping forks**

Set 4 forchettine pralineria  
Pralinen Gabelchen, 4 Stk.  
Jeu de 4 ébauchoirs  
Set de 4 herramientas para decorar chocolates

art.

47833-04



**SS**

**Set 2 decorating spoons**

Set 2 cucchiai decorazione  
Satz 2 Dekoration-Löffel  
Set 2 cuillères pour décorer  
2 cucharas para decoración

art. l. cm.

47831-02 19-23



**STAINLESS STEEL NOZZLES**  
**BOCCHETTE INOX**



**Set 12 pcs, one piece nozzles**

Set 12 bocchette unipezzo  
Tüllen Set 12 Stk. aus einem Stück gezogen

Set 12 pcs douilles monobloc  
Surtido 12 boquillas monobloc

art.	Ø mm.	base ø mm.
47357-20	1x 0,6-1,2-1,5-1,9-2,4-3 3,6-4,8-5,6-6,4-6,8-7,6	18

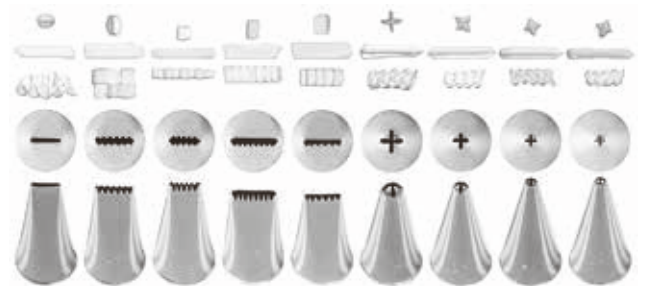

**Set 9 pcs, one piece nozzles**

Set 9 bocchette unipezzo  
Tüllen Set 9 Stk. aus einem Stück gezogen

Set 9 pcs douilles monobloc  
Surtido 9 boquillas monobloc

art.	base ø mm.
47357-24	18



**Set 7 pcs, one piece nozzles**

Set 7 bocchette unipezzo  
Tüllen Set 7 Stk. aus einem Stück gezogen

Set 7 pcs douilles monobloc  
Surtido 7 boquillas monobloc

art.	Ø mm.	base ø mm.
47357-21	1x 1,7-2,2-3,5-4,2-5-5,5-7	18



**Set 8 pcs, one piece nozzles**

Set 8 bocchette unipezzo  
Tüllen Set 8 Stk. aus einem Stück gezogen

Set 8 pcs douilles monobloc  
Surtido 8 boquillas monobloc

art.	Ø mm.	base ø mm.
47357-22	1x 1-1,5-1,8-2,6-3-3,4-2,5-7	18





**Set 8 pcs, one piece nozzles**

Set 8 bocchette unipezzo

Tüllen Set 8 Stk. aus einem Stück gezogen

Set 8 pcs douilles monobloc

Surtido 8 boquillas monobloc

art. base ø mm.

47357-28 18



**Set 8 pcs, one piece nozzles**

Set 8 bocchette unipezzo

Tüllen Set 8 Stk. aus einem Stück gezogen

Set 8 pcs douilles monobloc

Surtido 8 boquillas monobloc

art. base ø mm.

47357-29 18



**Set 8 pcs, one piece nozzles**

Set 8 bocchette unipezzo

Tüllen Set 8 Stk. aus einem Stück gezogen

Set 8 pcs douilles monobloc

Surtido 8 boquillas monobloc

art. base ø mm.

47357-30 18

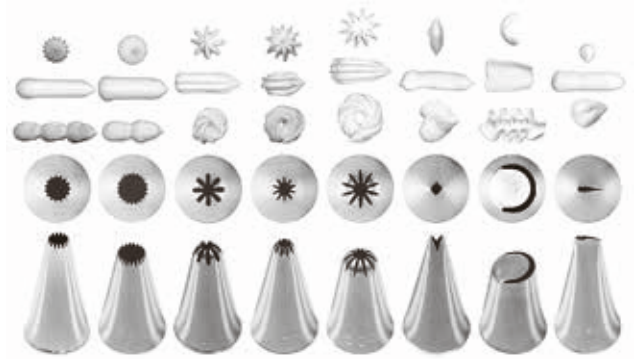

**Set 8 pcs, one piece nozzles**

Set 8 bocchette unipezzo

Tüllen Set 8 Stk. aus einem Stück gezogen

Set 8 pcs douilles monobloc

Surtido 8 boquillas monobloc

art. base ø mm.

47357-31 18



**Set 6 pcs, one piece nozzles**

Set 6 bocchette unipezzo

Tüllen Set 6 Stk. aus einem Stück gezogen

Set 6 pcs douilles monobloc

Surtido 6 boquillas monobloc

art. base ø mm.

47357-06 25



**Set 6 pcs, one piece nozzles**

Set 6 bocchette unipezzo

Tüllen Set 6 Stk. aus einem Stück gezogen

Set 6 pcs douilles monobloc

Surtido 6 boquillas monobloc

art. base ø mm.

47357-07 25





**Set 6 pcs, one piece nozzles**

Set 6 bocchette unipezzo  
Tüllen Set 6 Stk. aus einem Stück gezogen  
Set 6 pcs douilles monobloc  
Surtido 6 boquillas monobloc

art. base ø mm.  
47357-08 25

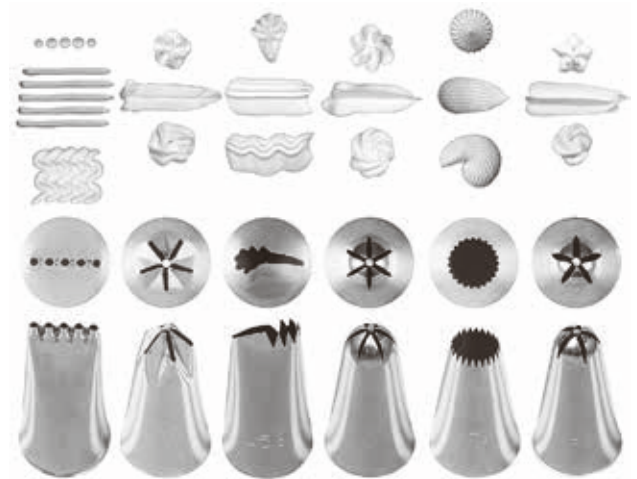

**Set 6 pcs, one piece nozzles**

Set 6 bocchette unipezzo  
Tüllen Set 6 Stk. aus einem Stück gezogen  
Set 6 pcs douilles monobloc  
Surtido 6 boquillas monobloc

art. base ø mm.  
47357-09 25

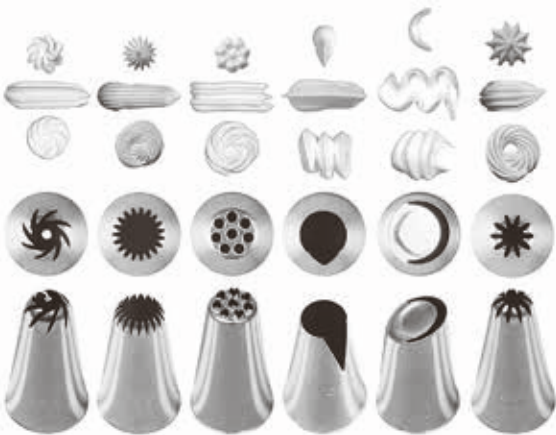

**Set 6 pcs, one piece nozzles**

Set 6 bocchette unipezzo  
Tüllen Set 6 Stk. aus einem Stück gezogen  
Set 6 pcs douilles monobloc  
Surtido 6 boquillas monobloc

art. base ø mm.  
47357-10 25



**Set 6 pcs, one piece nozzles**

Set 6 bocchette unipezzo  
Tüllen Set 6 Stk. aus einem Stück gezogen  
Set 6 pcs douilles monobloc  
Surtido 6 boquillas monobloc

art. base ø mm.  
47357-11 25



**Set 4 pcs, one piece nozzles**

Set 4 bocchette unipezzo  
Tüllen Set 4 Stk. aus einem Stück gezogen  
Set 4 pcs douilles monobloc  
Surtido 4 boquillas monobloc

art. base ø mm.  
47357-02 2x 31 - 2x 36



**Set 7 pcs, one piece nozzles**

Set 7 bocchette unipezzo  
Tüllen Set 7 Stk. aus einem Stück gezogen  
Set 7 pcs douilles monobloc  
Surtido 7 boquillas monobloc

art. base ø mm.  
47357-03 31



**Set 3x2 nozzles**

Set 3x2 bocchette

3x2 Stk. Tüllen

Set 3x2 pcs douilles

Juego 3x2 boquillas

art.	Ø mm.	stars
47350-01	2x 25	6
	2x 31	6
	2x 36	6



**Set 3x2 nozzles**

Set 3x2 bocchette

3x2 Stk. Tüllen

Set 3x2 pcs douilles

Juego 3x2 boquillas

art.	Ø mm.	stars
47351-01	2x 31	6
	2x 31	8
	2x 36	9



**Set 3x2 nozzles**

Set 3x2 bocchette

3x2 Stk. Tüllen

Set 3x2 pcs douilles

Juego 3x2 boquillas

art.	Ø mm.	stars
47352-01	2x 31	6
	2x 31	8
	2x 36	9



**Set 6 pcs, one piece nozzles**

Set 6 bocchette unipezzo

Tüllen Set 6 Stk. aus einem Stück gezogen

Set 6 pcs douilles monobloc

Surtido 6 boquillas monobloc

art.	Ø mm.	stars
47208-01	3,0	5
47208-02	3,0	6
47208-03	3,5	7
47208-04	5,0	8



**Set 6 pcs, one piece nozzles**

Set 6 bocchette unipezzo

Tüllen Set 6 Stk. aus einem Stück gezogen

Set 6 pcs douilles monobloc

Surtido 6 boquillas monobloc

art.	Ø mm.	stars
47208-05	5	5
47208-06	5	6
47208-07	6	7
47208-08	7	8



**Set 6 pcs, one piece nozzles**

Set 6 bocchette unipezzo

Tüllen Set 6 Stk. aus einem Stück gezogen

Set 6 pcs douilles monobloc

Surtido 6 boquillas monobloc

art.	Ø mm.	stars
47208-09	7	5
47208-10	7	6
47208-11	7	7
47208-12	9	8



**Set 6 pcs, one piece nozzles**

Set 6 bocchette unipezzo

Tüllen Set 6 Stk. aus einem Stück gezogen

Set 6 pcs douilles monobloc

Surtido 6 boquillas monobloc

art.	Ø mm.	stars
47208-13	11	5
47208-14	11	6
47208-15	11	7
47208-16	11	8





**Set 6 pcs, one piece nozzles**

Set 6 bocchette unipezzo  
Tüllen Set 6 Stk. aus einem Stück gezogen  
Set 6 pcs douilles monobloc  
Surtido 6 boquillas monobloc

art.	Ø mm.	stars
47208-17	13	5
47208-18	13	6
47208-19	13	7
47208-20	13	8



**Set 6 pcs, one piece nozzles**

Set 6 bocchette unipezzo  
Tüllen Set 6 Stk. aus einem Stück gezogen  
Set 6 pcs douilles monobloc  
Surtido 6 boquillas monobloc

art.	Ø mm.	stars
47208-21	18	5
47208-22	18	6
47208-23	18	7
47208-24	18	8



**Set 6 pcs, one piece nozzles**

Set 6 bocchette unipezzo  
Tüllen Set 6 Stk. aus einem Stück gezogen  
Set 6 pcs douilles monobloc  
Surtido 6 boquillas monobloc

art.	Ø mm.	stars
47354-02	2	6
47354-04	4	6
47354-06	6	6
47354-08	8	6
47354-10	10	6
47354-12	12	7
47354-14	14	8
47354-16	16	9
47354-18	18	10



**Set 6 pcs, one piece nozzles**

Set 6 bocchette unipezzo  
Tüllen Set 6 Stk. aus einem Stück gezogen  
Set 6 pcs douilles monobloc  
Surtido 6 boquillas monobloc

art.	Ø mm.	stars
47355-02	2,5	6
47355-04	4,0	6
47355-06	6,0	6
47355-08	8,0	7
47355-10	10	8
47355-12	12	10



**Set 6 pcs, one piece nozzles**

Set 6 bocchette unipezzo  
Tüllen Set 6 Stk. aus einem Stück gezogen  
Set 6 pcs douilles monobloc  
Surtido 6 boquillas monobloc

art.	Ø mm.	stars
47356-02	2,0	5
47356-04	4,0	9
47356-06	5,5	9
47356-08	7,0	10
47356-10	8,5	12
47356-12	13,0	15
47356-14	14,5	16
47356-16	16,0	17
47356-18	17,5	18



**Set 6 pcs, one piece nozzles**

Set 6 bocchette unipezzo  
Tüllen Set 6 Stk. aus einem Stück gezogen  
Set 6 pcs douilles monobloc  
Surtido 6 boquillas monobloc

art.	Ø mm.
47353-02	2
47353-04	4
47353-06	6
47353-08	8
47353-10	10
47353-12	12
47353-14	14
47353-16	16
47353-18	18
47353-20	20
47353-22	22
47353-24	24



**Set 6 pcs, one piece nozzles**

Set 6 bocchette unipezzo  
Tüllen Set 6 Stk. aus einem Stück gezogen  
Set 6 pcs douilles monobloc  
Surtido 6 boquillas monobloc

art.	Ø mm.
47207-20	20
47207-25	25
47207-30	30



**Set 10 pcs Bismark nozzles**

Set 10 bocchette a imbuto  
Fülltüllen Set 10 Stk.  
Set 10 douilles à choux  
Surtido 10 boquillas para relleno

art.	Ø mm.	l. mm.
47127-04	4	90
47127-06	6	75
47127-08	8	90





**Nozzle**  
Bocchetta decorativa  
Spritztülle  
Douille  
Boquilla

art.	Ø mm.	h. cm.
47357-50	55	6



**Nozzle**  
Bocchetta decorativa  
Spritztülle  
Douille  
Boquilla

art.	Ø mm.	h. cm.
47357-51	55	5,6



**Nozzle**  
Bocchetta decorativa  
Spritztülle  
Douille  
Boquilla

art.	Ø mm.	h. cm.
47357-40	32	6,0



**Nozzle**  
Bocchetta decorativa  
Spritztülle  
Douille  
Boquilla

art.	Ø mm.	h. cm.
47357-41	32	5,7



**Nozzle**  
Bocchetta decorativa  
Spritztülle  
Douille  
Boquilla

art.	Ø mm.	h. cm.
47357-42	32	5,7



**Nozzle**  
Bocchetta decorativa  
Spritztülle  
Douille  
Boquilla

art.	Ø mm.	h. cm.
47357-43	32	5,7



**Nozzle**  
Bocchetta decorativa  
Spritztülle  
Douille  
Boquilla

art.	Ø mm.	h. cm.
47357-44	32	5,7



**Set of 6 nozzles**  
Set 6 bocchette  
Tüllen Set, 6 Stk  
Set 6 douilles  
Juego 6 boquillas

art.	Ø mm.
47214-86	5-7-9-11-13-15

PP



**Set of 6 nozzles**  
Set 6 bocchette  
Tüllen Set, 6 Stk  
Set 6 douilles  
Juego 6 boquillas

art.	Ø mm.
47215-86	3-5-7-9-11-13

PP



**Set of 12 nozzles**  
Set 12 bocchette  
Tüllen Set, 12 Stk  
Set 12 douilles  
Juego 12 boquillas

art.	Ø mm.
47618-10	2x10
47618-20	10x20

PP



**Set of 12 nozzles**  
Set 12 bocchette  
Tüllen Set, 12 Stk  
Set 12 douilles  
Juego 12 boquillas

art.
47250-12

PC

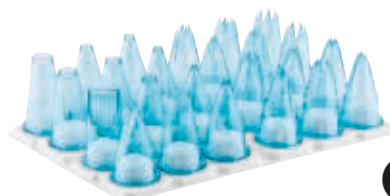

**Set of 24 nozzles**  
Set 24 bocchette  
Tüllen Set, 24 Stk  
Set 24 douilles  
Juego 24 boquillas

art.
47250-24

PC



**Flower nozzles 12 pcs**  
Bocchette floreali 12 pz  
Spritztüllen 12 Stk  
Douille fleurs 12 pcs  
Boquillas florales 12 pz  
art.  
47357-38



**Set of 29 nozzles**  
Set 29 bocchette  
Tüllen Set, 29 Stk  
Set 29 douilles  
Juego 29 boquillas  
art.  
47219-29



**Set of 38 nozzles**  
Set 38 bocchette  
Tüllen Set, 38 Stk  
Set 38 douilles  
Juego 38 boquillas  
art.  
47219-38



**Set of 55 nozzles**  
Set 55 bocchette  
Tüllen Set, 55 Stk  
Set 55 douilles  
Juego 55 boquillas  
art.  
47219-55

**26 tubes, 2 flower nails, 1 standard coupler. – 26 bocchette, 2 chiodi per fiori, 1 adattatore standard.**



**External piping tip adapter**  
Adattatore per bocchette  
Adapter für Spritztüllen  
Adaptateur à douilles  
Adaptador para boquillas  
art.      Ø mm.      des.  
47212-01      18      STANDARD

**35 tubes, 1 medium coupler, 1 large coupler. – 35 bocchette, 1 adattatore medio, 1 grande.**



**External piping tip adapter**  
Adattatore per bocchette  
Adapter für Spritztüllen  
Adaptateur à douilles  
Adaptador para boquillas  
art.      Ø mm.      des.  
47212-02      25-31      MEDIUM

**52 tubes, 2 flower nails, 1 standard coupler. – 52 bocchette, 2 chiodi per fiori, 1 adattatore standard.**



**External piping tip adapter**  
Adattatore per bocchette  
Adapter für Spritztüllen  
Adaptateur à douilles  
Adaptador para boquillas  
art.      Ø mm.      des.  
47212-03      36      LARGE



**Nozzles adapter, 2 pcs**  
Adattatori per bocchette, 2 pz  
Spritztüllen-Adapter, 2 Stk  
Adaptateurs à douilles, 2 pièces  
Adaptadores boquillas, 2 piezas  
art.  
47212-05

**To prepare decorations with 2 or 3 colours. Suitable for piping tips base Ø 30 h 50 mm. Per decorazioni a 2 o 3 colori. Adatte a bocchette base Ø 30 h 50 mm.**



**Pastry tube brush, 6 pcs**  
Bruschino per bocchette, 6 pz  
Tüllen-Bürste, 6 Stk  
Brosse à douilles, 6 pcs  
Cepillo para boquillas, 6 pz  
art.      Ø cm.      l. cm.  
47200-01      0,8      10  
47200-02      0,5-2,4      12,5



**Cream roll molds, 10 pcs**

Cannoli, 10 pz  
Sahnerolle, konisch/gerade, 10 Stk  
Rouleau à fromage, 10 pcs  
Rodillos queso, 10 pz

art.	Ø mm.	l. mm.
47020-15	15	92
47020-20	22	142
47020-30	10-25	139
47020-35	20-25	171



**Cream horn molds, 10 pcs**

Cornetti, 10 pz  
Schillerlockenform, 10 Stk  
Moulet à cornet, 10 pcs  
Moldes para conos, 10 pz

art.	Ø mm.	l. mm.
47021-35	34	110
47021-45	47	161



**Decorating set 8 pcs**

Kit decoro 8 pezzi  
Dekorations-Set, 8-teilig  
Set 8 pcs à décorer  
Juego 8 piezas para decorar

art.
47120-01

**6 small tubes, 1 standard coupler, 1 bag cm. 35**  
6 bocchette piccole, 1 adattatore standard,  
1 sacchetto 35 cm.



**Decorating set 8 pcs**

Kit decoro 8 pezzi  
Dekorations-Set, 8-teilig  
Set 8 pcs à décorer  
Juego 8 piezas para decorar

art.
47120-02

**6 medium tubes, 1 medium coupler, 1 bag cm. 40.** – 6 bocchette medie, 1 adattatore medio, 1 sacchetto 40 cm.



**Icing bag**

Sacchetto per decorare  
Spritzbeutel  
Sac à dresser  
Mangas para decorar

art.	h. cm.	U. Pack
47106-28	28	6
47106-34	34	6
47106-40	40	6
47106-46	46	6
47106-50	50	6

**Synthetic fibre with multi-layer water-proof plastic coating.**



**Icing bag**

Sacchetto per decorare  
Spritzbeutel  
Sac à dresser  
Mangas para decorar

art.	h. cm.	U. Pack
47106-55	55	6
47106-60	60	6
47106-65	65	6
47106-70	70	6
47106-75	75	6

**Fibra sintetica con rivestimento a strati in plastica impermeabile.**



**Icing bag**

Sacchetto per decorare  
Spritzbeutel  
Sac à dresser  
Mangas para decorar

art.	h. cm.	U. Pack
47105-28	28	6
47105-34	34	6
47105-40	40	6
47105-46	46	6
47105-50	50	6

**With reinforced tip, seam and hanger. Cotton with multi-layer water-proof plastic coating.**



**Icing bag**

Sacchetto per decorare  
Spritzbeutel  
Sac à dresser  
Mangas para decorar

art.	h. cm.	U. Pack
47105-55	55	6
47105-60	60	6
47105-65	65	6
47105-70	70	6
47105-75	75	6

**Con punta rinforzata, orlo e gancio. Cotone con rivestimento a strati in plastica impermeabile.**



**Icing bag**

Sacchetto per decorare  
Spritzbeutel  
Sac à dresser  
Mangas para decorar

art.	h. cm.	U. Pack
47119-30	30	6
47119-35	35	6
47119-40	40	6
47119-45	45	6
47119-50	50	6
47119-60	60	6

**With reinforced tip, seam and hanger. Polyurethan with nylon coating. High frequency electric seaming.** – Con punta rinforzata, orlo e gancio. Poliuretano con rivestimento in nylon. Saldatura ad alta frequenza.



**PE**

**Double pastry bag**

Sacchetto per decorare doppio  
Doppeldressierbeutel  
Sac à dresser, double  
Mangas para decorar, doble

art.	my	cm.	pcs/pz
47104-45	70	45,5x30,5	75

**Disposable. For 2 ingredients. Closed tip, can be used without tube.**

Monouso. Per 2 ingredienti. Punta chiusa, può essere utilizzato senza bocchette.



**Icing bag, polyurethane**

Sacchetto per decorare, poliuretano  
Spritzbeutel, Polyurethan  
Sac à dresser, polyuréthane  
Mangas para decorar, poliuretano

art.	h. cm.
47112-34	34
47112-45	45
47112-50	50

47112-34	34
47112-45	45
47112-50	50



**PE**

**Disposable icing bag**

Sacchetto per decorare, monouso  
Einwegspritzbeutel  
Sac à dresser jetable  
Mangas desechables

art.	my	h. cm.	pcs/pz
47118-30	80	30	100
47118-40	80	40	100
47118-55	80	55	100
47118-65	80	65	100



**PE**

**Disposable icing bag**

Sacchetto per decorare, monouso  
Einwegspritzbeutel  
Sac à dresser jetable  
Mangas desechables

art.	my	h. cm.	pcs/pz
47111-30	80	30	100
47111-40	80	40	100
47111-46	80	55	100
47111-55	80	65	100



**PE**

**Disposable icing bag**

Sacchetto per decorare, monouso  
Einwegspritzbeutel  
Sac à dresser jetable  
Mangas desechables

art.	my	h. cm.	pcs/pz
47114-40	100	40	80
47114-55	100	55	80



**BPA FREE**

**PP**

**Bag clip**

Clip chiudi sacco  
Verschluss-Clip  
Clip ferme sachet  
Pinza cierra bolsas

art.	cm.	pcs/pz
42908-24	21	1

**Freezer, dishwasher and microwave safe. Safe to use with food.** – Idonei ad uso in freezer, lavastoviglie e microonde. Per alimenti.



**SS**

**Cookie press and icing set 20 pcs**

Siringa per pasticceria, set 20 pezzi  
Gebäckspritze-Satz, 20 Stk.  
Seringue à biscuits, jeu 20 pcs  
Juego pistola repostería, juego 20 pcs.

art.	ml.
47010-20	250

**For a correct use of the syringe we suggest shortbread dough.** – Per un utilizzo ottimale della siringa suggeriamo la frolla montata.







SS

**Icing bags & nozzles wall rack**  
Espositore sacchetti/bocchette  
Spritzbeutel-/ u. Tüllenaufhänger  
Séchoir à poche et douilles  
Secador mangas y boquillas

art. dim. cm.  
47113-03 50x42x50



SS

**Wall rack for icing bags**  
Espositore per sacchetti  
Spritzbeutelaufräger  
Séchoir à poche  
Secador cuelga-mangas

art. dim. cm.  
47107-00 50x42x26

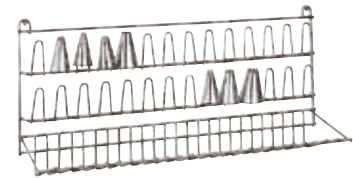

SS

**Wall rack for nozzles**  
Espositore per bocchette  
Tüllenaufhänger  
Séchoir à douilles  
Secador boquillas

art. dim. cm.  
47108-00 50x13x24



PP

**Icing bag holder**  
Vaso porta sacchetto  
Spritzbeutel-Absetzständer  
Support à poches  
Soporte para mangas

art. Ø cm. h. cm.  
47110-23 19,5 23



**Cake plate, swivel base, aluminum**  
Girello, alluminio  
Tortendrehplatte, aluminium  
Guéridon plaque tournante, alu  
Pedestal giratorio para tartas, aluminio

art. Ø cm. h. cm.  
47101-30 30 10



**Cake plate, swivel base, aluminum**  
Girello, alluminio  
Tortendrehplatte, aluminium  
Guéridon plaque tournante, alu  
Pedestal giratorio para tartas, aluminio

art. dim. cm.  
47101-40 30x40x10



MF

**Cake-plate, swivel base**  
Girello per decorazione torte  
Tortendrehplatte  
Guéridon plaque tournante  
Pedestal giratorio para tartas

art. Ø cm. h. cm.  
47103-32 32 10



PE

**Protection cover**  
Campana  
Abdeckhauben  
Cloche  
Tapa

art. Ø cm. h. cm.  
47103-30 30 12



SS

**Cake peel**  
Pala per torte  
Tortenschaukel  
Pelle à tarte  
Pala para tartas

art. Ø cm. dim. cm.  
47094-30 30 27x26



**Doilies**  
Pizzi sottotorta  
Tortenspitzen, Rosendekor  
Dentelles décor rose  
Blondas

art. dim. cm. pcs/pz  
47687-24 18-25 250



**Doilies**  
Pizzi sottotorta  
Tortenspitzen, Rosendekor  
Dentelles décor rose  
Blondas

art. dim. cm. pcs/pz  
47686-10 6-10 250  
47686-12 6,5-12 250  
47686-14 8-14 250  
47686-17 9,5-16,5 250  
47686-22 12,5-22 100  
47686-24 15-24 100



**Doilies**  
Pizzi sottotorta  
Tortenspitzen, Rosendekor  
Dentelles décor rose  
Blondas

art. dim. cm. pcs/pz  
47686-26 16-27 100  
47686-30 19-30 100  
47686-33 20-32 100  
47686-36 32-36 100  
47686-42 25-42 100

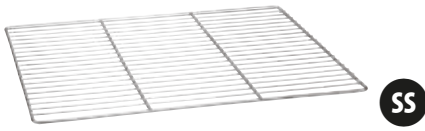

SS

**Draining rack**

Griglia di colaggio  
Überziehgitter  
Grille à glacer  
Rejilla

art.	dim. cm.
44430-60	60x40

**Frame ø mm 5, 2 cross-bars, 29 wires ø 2 mm.**  
Quadro ø mm 5, 2 traverse, 29 fili ø 2 mm.

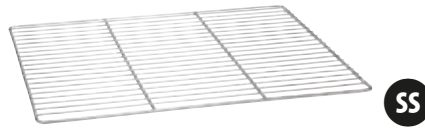

SS

**Draining rack**

Griglia di colaggio  
Überziehgitter  
Grille à glacer  
Rejilla

art.	dim. cm.
44430-61	60x40

**Frame ø mm 6, 2 cross-bars, 24 wires ø 3 mm.**  
Quadro ø mm 6, 2traverse, 24 fili ø 3 mm.



SS

**Draining rack**

Griglia di colaggio  
Überziehgitter  
Grille à glacer  
Rejilla

art.	dim. cm.
44431-46	46x30,5x2,5
44431-60	60x40x2,5

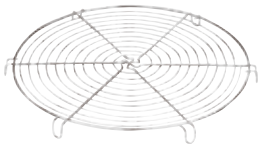

**Cake cooling tray, chromed**

Griglia di raffreddamento, cromata  
Tortengitter, verchromt  
Grille ronde à tourte, chromé  
Rejilla para tortas, cromada

art.	Ø cm.
47098-18	18,5
47098-22	22,0
47098-26	26,0
47098-30	30,0



**Baking tray, aluminum**

Teglia, alluminio  
Backblech, Aluminium  
Plaque à cuisson, aluminium  
Placa pastelería, aluminio

art.	GN	dim. cm.
41744-32	1/1	32,5x53x1
41744-53	2/1	53x65x1
41744-60	-	60x40x1

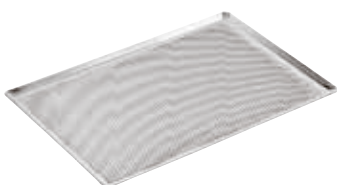

**Baking tray perforated, aluminum**

Teglia forata, alluminio  
Backblech, Aluminium, gelocht  
Plaque perforée, aluminium  
Placa pastelería perforada, aluminio

art.	GN	dim. cm.
41756-30*	-	30x40x1
41756-32	1/1	32,5x53x1
41756-53	2/1	53x65x1
41756-60	-	60x40x1

\* **Open edges.** – Angoli aperti.



**Baking tray, alusteel**

Teglia rettangolare, alluminata  
Backblech mit Aluminiumüberzug  
Plaque, tôle aluminitée  
Placa pastelería, aluminizada

art.	dim. cm.
41746-60	60x40x2



**Baking tray, alusteel**

Teglia rettangolare, alluminata  
Backblech mit Aluminiumüberzug  
Plaque, tôle aluminitée  
Placa pastelería, aluminizada

art.	dim. cm.
41751-30	30x23x3
41751-35	35x28x3
41751-40	40x30x3
41751-50	50x35x3
41751-60	60x40x3
41751-65	65x45x3

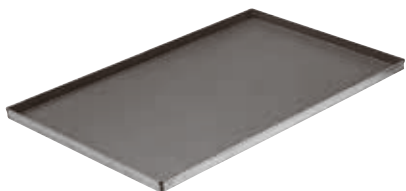

**Baking tray, non stick coated**  
Teglia rettangolare, antiaderente  
Backblech mit Antihafbeschichtung  
Plaque revêtement anti-adhésif  
Placa pastelería anti-adherente

art.	dim. cm.
41747-60	60x40x2



**Baking tray, non stick coated**  
Teglia antiaderente  
Blech mit Antihafbeschichtung  
Plaque avec revêtement anti-adhésif  
Placa antiadherente

art.	GN	dim. cm.
41743-32	1/1	32,5x53x1
41743-53	2/1	53x65x1
41743-60	-	60x40x1

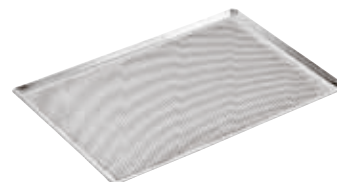

**Baking tray perforated, non stick coated**  
Teglia forata, antiaderente  
Blech, gelocht mit Antihafbeschichtung  
Plaque perforée, revêtement anti-adhésif  
Placa perforada, antiadherente

art.	GN	dim. cm.
41753-30*	-	30x40x1
41753-32	1/1	32,5x53x1
41753-53	2/1	53x65x1
41753-60	-	60x40x1

\* Open edges. – Angoli aperti.

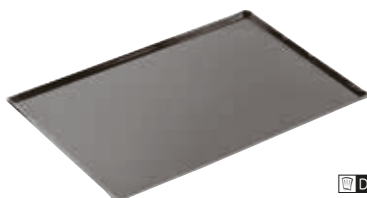

**Baking tray, aluminum, silicone coated**  
Teglia, alluminio siliconato  
Alu-Backblech, Silikonbeschichtet  
Plaque alu, revêtement silicone  
Placa aluminio siliconada

art.	GN	dim. cm.
41743D32	1/1	53x32,5
41743D53	-	53x65
41743D60	-	40x60

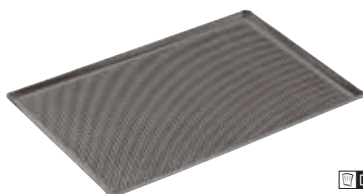

**Baking tray, perforated aluminum, silicone coated**  
Teglia, alluminio siliconato, forato  
Alu-Backblech, gelocht, Silikonbeschichtet  
Plaque alu perforée, revêtement silicone  
Placa aluminio perforada siliconada

art.	GN	dim. cm.
41753D30	-	30x40
41753D32	1/1	53x32,5
41753D53	-	53x65
41753D60	-	40x60

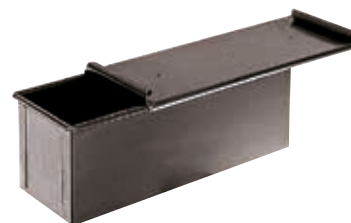

**Bread mold, blue steel**  
Bacinella carré, ferro blu  
Brotform, Blaublech  
Pain de mie, tôle bleuie  
Molde, hierro

art.	dim. cm.
41748-20	20x10x10
41748-30	30x10x10
41748-35	35x10x10
41748-40	40x10x10
41748-50	50x10x10



**Bread mold, alusteel**  
Bacinella carré, alluminata  
Brotform mit Aluminiumüberzug  
Pain de mie, tôle aluminitée  
Molde, acero aluminizado

art.	dim. cm.
41750-20	20x10x10
41750-30	30x10x10
41750-40	40x10x10
41750-41	40x15x15
41750-50	50x10x10



**Confectionery funnel**  
Imbuto colatore  
Likör- u. Fondanttrichter  
Entonnoir à fondant  
Embudo colador

art.	Ø cm.	h. cm.	lt.
47800-22	22	21	2

Supplied with 3 nozzles ø 2, 4, 6 mm.  
Con 3 bocchette ø 2, 4, 6 mm.



**Confectionery funnel**  
Imbuto colatore  
Likör- u. Fondanttrichter  
Entonnoir à fondant  
Embudo colador

art.	Ø cm.	h. cm.	lt.
47801-20	14	20	0,9

Supplied with 3 nozzles ø 4, 6, 7,5 mm.  
Con 3 bocchette ø 4, 6, 7,5 mm.





SS

**Cream dispenser**

Dosa creme  
Dosierer  
Doseur à crème  
Dosificador

art.	dim. cm.
47612-01	20x16x23



**Cream injector, cast aluminum**

Dosatrice per creme, alluminio pressofuso  
Gebäkfüllmaschine  
Entonnoir à crème  
Dosificador de porciones

art.	dim. cm.	lt.
47694-03	44x25	3

**Funnel, cylinder, piston, injector, lever and thrust rib in s/s. Piston: ø 24 mm. Doses: 1-12 gr.**

Imbuto, cilindro, pistone, iniettore, leva e nasello di spinta in acciaio inox. Pistone: ø 24 mm. Dosi: 1-12 gr.



**Caramelising rod**

Caramellizzatore  
Caramelisier-Eisen  
Fer à caraméliser  
Quemador

art.	Ø cm.
47846-10	10,5



**Electric caramelising rod**

Caramellizzatore elettrico  
Caramelisier-Eisen, elektrisch  
Fer à caraméliser électrique  
Quemador eléctrico

art.	Ø cm.	kW
47847-10	10	0,65
47847-12	12	1,00



**Electric caramelising rod**

Caramellizzatore elettrico  
Caramelisier-Eisen, elektrisch  
Fer à caraméliser électrique  
Quemador eléctrico

art.	l. cm.	kW
47847-23	23	1,5



**Electric spray gun**

Pistola elettrica  
Sprühpistole, elektrisch  
Pistolet électrique  
Pistola eléctrica

art.	ml.	W
47848-07	700	60

**Bar 0-160, rpm 250 - For butter, oil, fat, wax, jelly, jam, chocolate, releasing agents and emulsions. Usable for hot liquids max. 65 °C. Nozzle 0,6 mm. - Per burro, oli, cera, gelatina, marmellata, cioccolata, antiagglomeranti ed emulsionanti. Per liquidi caldi max. 65°C. Bocchetta 0,6 mm.**



**Airbrush compressor**

Compressore per penna aerografa  
Airbrush Kompressor  
Compresseur  
Compresor

art.	dim. cm.	bar	kW
47844-06	16x30x23	4	0,2

**Power 1/5 HP. Air output per min./litres: 23-25. Voltage: 220-240V/50HZ. Max. pressure 6,5 bar/95PSI. - Potenza 1/5 HP. Volume aria min. 23-25L. Voltaggio 220-240V/50HZ. Pressione Massima 6,5 bar/95PSI.**



**Airbrush, double action**

Penna aerografa, doppia azione  
Airbrush-Pistole, Doppelaktion  
Aérographe, dual action  
Equipo aerógrafo, doble acción

art.	Ø mm.	cap.
47844-02	0,3	7 cc



**Airbrush stand**

Supporto penna aerografa  
Airbrush-Pistole Gestell  
Support aérographe  
Soporte aerógrafo

art.
47844-01





SS

**Sugar lamp**

Lampada per zucchero  
Zuckerlampe  
Lampe à sucre  
Lámpara para azúcar

art. dim. cm.  
47840-11 61x41x50

**Infrared lamp, 3 selection powers 500-1000-1500W. Cable included.** – Lampada infrarossi con 3 potenze selezionabili, 500-1000-1500W. Incl. cavo di alimentazione.



ABS

**Tempering unit**

Temperatrice  
Temperiergerät  
Tempereuse  
Templadora

art. Ø cm. h. cm. lt.  
47698-01 20,5 21,2 1,7

**Ideal for chocolate coatings of ice creams on sticks. Removable anodized aluminum tank.** Ideale per coperture in cioccolato di gelati su stecco. Vasca estraibile in alluminio anodizzato.



ABS

**Tempering unit**

Temperatrice  
Temperiergerät  
Tempereuse  
Templadora

art. Ø cm. h. cm. lt.  
47698-02 26 16 1,8

**Mini dry melter, allows to process tiny chocolate quantities. Practical removable tank.** Mini scioglitore a secco, adatto per piccole produzioni. Pratica vasca estraibile.



SS

ABS

**Tempering unit**

Temperatrice  
Temperiergerät  
Tempereuse  
Templadora

art. dim. cm. lt.  
47698-03 40x24x13,5 3,6  
47698-06 40x33x13,5 6,0

**Analog tempering units. Different wirings upon request.** – Temperatrici analogiche. Su richiesta cablaggio: GB/USA/GIAPPONE/AUSTRALIA/CINA.



ABS

SS

**Tempering unit, digital**

Temperatrice digitale  
Temperiergerät, digital  
Tempereuse digitale  
Templadora digital

art. dim. cm. lt.  
47698-07 40x33x13,5 6,0

**With thermal probe. Tempering manually adjustable or following the 3 programs: white, milk and dark chocolate.**

Con sonda termica. Temperaggio regolabile manualmente o seguendo i 3 programmi per cioccolato bianco, al latte e fondente.



**Chef's torch**

Cannello professionale  
Profi-Wärmepistole  
Chalumeau de cuisine  
Soplete cocina

art. dim. cm. ml.  
47841-03 8x7x16 200



**Chef's torch**

Cannello professionale  
Profi-Wärmepistole  
Chalumeau de cuisine  
Soplete cocina

art. dim. cm. ml.  
47841-04 12x7x18 280



**Sugar bulb**

Pompetta con terminale in rame  
Blaszuckerspritze  
Poire à sucre soufflé  
Pera para azúcar soplado

art.  
47838-00





**Sugar/jam thermometer**

Termometro per zucchero/marmellata  
Zucker- und Marmeladenthermometer  
Thermomètre à sucre et confiture  
Termómetro azúcar y mermelada

art.	scala	°C
47843-05	2°C	+40+200°C

**Brass. – Ottone. Dim. 4,7x20 cm.**



**SS**

**Sugar thermometer**

Termometro per zucchero  
Zuckerthermometer  
Thermomètre à sucre  
Termómetro para azúcar

art.	scala	°C
47843-00	1°C	+80+200



**SS**

**Sugar thermometer holder**

Reggi caramellometro  
Zuckerthermometer-Träger  
Support pour thermomètre à sucre  
Soporte para termometro azúcar

art.	h. cm.
47842-00	32



**Syrup density meter test tube**

Provetta alimentare graduata, plastica  
Sirup-Hydrometer-Becher  
Epruvette pèse-sirop  
Probeta aerómetro

art.	Ø cm.	h. cm.	ml.
49703-01	3	25	100

**Can be sterilized up to 120°C.**  
Sterilizzabile fino a 120°C.



**Syrup density meter**

Pesa sciroppo (densimetro)  
Sirup-Hydrometer  
Pèse-sirop  
Aerómetro

art.	l. cm.
49703-00	12,5

**Temp.: 20°C - gr./ml./°Bé: 1.100/1.400/15-40 -**  
**Div.: 0,010 g/ml/2°Bé**



**PA+**  
plus

**Angular spatula**

Spatola angolare  
Winkelpalette  
Spatule angulaire  
Espátula angular

art.	l. cm.
12909-12	12
12909-23	23



**ABS**

**Smoother**

Stendipasta  
Teig-Glätter  
Lisse-pâte  
Espátula para alisar

art.	dim. cm.
47627-01	16x8



**Biscuit spatula**

Spatola per biscuit  
Biscuit-Spachtel  
Spatule à biscuit  
Espátula para biscuit

art.	l. cm.
47626-55	55,5



**Ruler**

Riga  
Lineal  
Règle  
Regla

art.	l. cm.
47033-50	60

**5 divisions cm 12 and 7 divisions cm 8.**  
5 divisioni 12 cm e 7 da 8 cm.



**Cake slicer**

Lira per pan di Spagna  
Tortendrahtschneider  
Lyre à genoise  
Cortador de pasteles

art.	Ø cm.	h. cm.
47031-44	30	20>60



**Cake slicer, 3 cutting wires**

Lira per pan di Spagna, 3 fili  
Tortendrahtschneider, 3 Drähte  
Lyre à genoise, 3 lames  
Cortador de pasteles 3 alambres

art.	Ø cm.	h. cm.
47031-46	46	10>90



PE

**Ganache frame set**

Set telaio per ganache  
Ganache Rahmenset  
Ensemble cadres à ganache  
Conjunto de marcos para ganache

art.	dim. cm.
47693-00	39x45x13

**Base, plastic spatula, 2 frames H 5 mm, 2 frames H 3 mm. Internal size 24x24 cm.**

Base, spatola plastica, 2 telai H 5 mm, 2 telai H 3 mm. Misura interna 24x24 cm.



SS

**Single frame**

Telaio singolo  
Rahmen  
Cadre  
Marco

art.	cm. ext.	cm. int.	h. mm.
47693-03	40x40	36x36	3
47693-05	40x40	36x36	5
47693-10	40x40	36x36	10
47693-15	40x40	36x36	15



PE

ABS

SS

**Mini guitar**

Chitarra mini  
Pralinenschneider Mini  
Mini-guitare  
Mini guitarra

art.	dim. cm.
47692-03	44,5x33,5x14

**Cutting frame 22 mm., s/s plate, plastic spatula, 3 spare wires, 2 spanners. Do not use for frozen pies, chocolate bars or generally hard paste. Cutting place 25x28 cm.** – Telaio di taglio 22 mm., piatto inox, spatola plastica, 3 fili di ricambio, 2 chiavi. Non usare per torte congelate, tavolette di cioccolata, impasti duri in genere. Piano di taglio 25x28 cm.



**Guitar**

Chitarra  
Pralinenschneider  
Guitare simple  
Guitarra

art.	dim. cm.
47692-01	39x45x13

**PST base, 3 s/s cutting frames of 22,5 - 30 - 45 mm. Including s/s plate, plastic spatula, 3 spare wires, 2 spanners. Cutting place 36x41 cm.** – Base PST, 4 telai inox da 22,5 - 30 e 45 mm. Inclusi piatto inospatola plastica, 3 fili di ricambio, 2 chiavi. Piano di taglio 36x41 cm.



**Double guitar**

Chitarra doppia  
Pralinenschneider, doppelt  
Guitare double  
Guitarra doble corte

art.	dim. cm.
47692-02	39x45x13

**PST base, 4 s/s cutting frames of 22,5 - 30 - 45 mm. and fixed side cutting frame 30 mm. Including s/s plate, plastic spatula, 3 spare wires, 2 spanners. Cutting place 38x42 cm.** – Base PST, 4 telai inox da 22,5 - 30 - 45 e laterale fisso da 30 mm. Inclusi piatto inox, spatola plastica, 3 fili di ricambio, 2 chiavi. Piano di taglio 38x42 cm.



SS

**Expanding pastry cutter**

Tagliapasta estensibile

Teigschneider

Rouleau extensible

Cortapastas extensible

art.	Ø cm.	l. cm.
47820-05	5,5	24
47820-07	5,5	24



SS

**Expanding pastry cutter**

Tagliapasta estensibile

Teigschneider

Rouleau extensible

Cortapastas extensible

art.	Ø cm.	l. cm.
47821-05	5,5	24
47821-07	5,5	24



SS

**Expanding pastry cutter**

Tagliapasta estensibile

Teigschneider

Rouleau extensible

Cortapastas extensible

art.	Ø cm.	l. cm.
47822-05	5,5	28
47822-07	5,5	28



SS

**Pastry wheel, plain**

Rotella taglia pasta liscia

Teigrädchen, glatt

Roulette à pâte lisse

Ruleta cortapasta

art.	Ø cm.	l. cm.
18325-01	5,5	18



SS

**Pastry wheel, fluted**

Rotella taglia pasta ondulata

Teigrädchen, gewellt

Roulette à pâte cannelée

Ruleta cortapasta acanalada

art.	Ø cm.	l. cm.
18325-02	5,5	18



SS

**Double pastry wheel**

Rotella taglia pasta lama doppia

Teigrädchen, glatt u. gewellt

Roulette à pâte double

Ruleta cortapasta doble

art.	Ø cm.	l. cm.
18325-03	5,5	18



**Cutting roller, POM**

Rullo tagliapasta, POM

Rollmesser, POM

Rouleau à lamelles, POM

Rodillo, POM

art.	cm.
47026-06	6



**Spiked roller, POM**

Rullo bucafoglia, POM

Stipprolle, POM

Pique-pâte, POM

Rodillo, POM

art.	cm.
47024-06	6,0
47024-10	11,5



**Cutting roller, POM**

Rullo per losanghe, POM

Rollmesser, POM

Rouleau à losanges, POM

Rodillo a rombos, POM

art.	cm.
47025-06	6,0
47025-10	11,5



SS

**Spiked roller**

Rullo bucafoglia

Stipprolle

Pique-pâte

Rodillo

art.	cm.
47028-12	12



SS

**Cutting roller**

Rullo per losanghe

Rollmesser

Rouleau à losanges

Rodillo a rombos

art.	cm.
47029-12	12



PP

SS

**Croissant cutter**

Taglia croissants

Dreieckschneidewalze

Coupe-croissants

Cortador para croissants

art.	dim. cm.
47027-11	18x20
47027-12	18x14
47027-13	11x15
47027-14	9,7x21
47027-15	18x20 2x
47027-16	18x20 3x





PS

**Stencil for grating pastry**

Stampo decora crostate  
Gitterstempel  
Empreinte pour grille de pâte  
Molde tortas

art.	Ø cm.
47030-30	30



PP

**Cake marker**

Segnaporzioni  
Tortenteiler  
Diviseur à tarte  
Marcador de tartas

art.	Ø cm.	por.
47032-10	26,5	10
47032-20	26,5	20



PP

**Cake marker, double-sided**

Segnaporzioni, doppio  
Tortenteiler, doppelseitig  
Diviseur à tarte, double  
Marcador de tartas, doble

art.	Ø cm.	por.
47033-08	18	8-12
47033-12	26,5	12-18
47033-14	26,5	14-18



**Rolling pin, non-stick coated**

Rullo antiaderente  
Rollwalze mit Antihafbeschichtung  
Rouleau avec revêtement anti-adhésif  
Rodillo amasador anti-adherente

art.	Ø cm.	l. cm.
47035-40	5,5	20
47035-48	6,5	25



W

**Rolling pin**

Rullo  
Rollwalze  
Rouleau  
Rodillo amasador

art.	Ø cm.	l. cm.
47036-30	9	30
47036-35	9	35
47036-40	9	40
47036-45	9	45
47036-50	9	50
47036-60	9	60



W

**Rolling pin**

Rullo  
Rollwalze  
Rouleau  
Rodillo amasador

art.	Ø cm.	l. cm.
47038-50	9	50
47038-60	7	60



PE

**Rolling pin**

Rullo  
Rollwalze  
Rouleau  
Rodillo amasador

art.	Ø cm.	l. cm.
47037-30	8,0	30
47037-40	7,5	40



PE

**Rolling pin**

Rullo  
Rollwalze  
Rouleau  
Rodillo amasador

art.	Ø cm.	l. cm.
47034-23	2,5	23
47034-51	5,0	50



W

**Rolling pin**

Rullo  
Rollwalze  
Rouleau  
Rodillo amasador

art.	Ø cm.	l. cm.
47034-52	5	50



SS

**Rolling pin**

Rullo  
Rollwalze  
Rouleau  
Rodillo amasador

art.	Ø cm.	l. cm.
47034-50	5	50



PE

**Rolling dough cutter**

Rullo tagliapasta  
Rollholzer  
Rouleau coupe-bandes  
Rodillo cortador

art.	l. cm.	cut mm.
47039-05	19	5
47039-10	19	10



PE

**Rolling dough cutter**

Rullo tagliapasta  
Rollholzer  
Rouleau coupe-bandes  
Rodillo cortador

art.	l. cm.	cut mm.
47039-15	19	15



NEW

**Pastry brush non-stick coated bristles**

Pennello setole antiaderenti  
Pinself, antihafbeschichtete Borsten  
Pinceau poils anti-adhérentes  
Pincel cerdas antiaderentes

art.	cm.	U. Pack
47640-25	2,5	1
47640-35	3,5	1
47640-50	5,0	1
47640-59	6,0	1

**Nylon bristles. Heat resistant up to +150°C.**  
Setole nylon. Resistente al calore fino a +150°C.



**Pastry brush**

Pennello per alimenti  
Kuchenpinsel  
Pinceaux à pâtissier  
Pincel de cocina

art.	cm.	U. Pack
47642-30	3,0	6
47642-40	4,0	6
47642-50	5,0	6
47642-60	6,0	6
47642-70	7,5	6

**Plastic handle, stainless steel ferrule.**  
Manico plastica, ghiera inox.



**Pastry brush**

Pennello per alimenti  
Kuchenpinsel  
Pinceaux à pâtissier  
Pincel de cocina

art.	Ø cm.	U. Pack
47644-15	1,5	6

**Plastic handle and ferrule.**  
Manico e ghiera plastica.



PA

**Pastry brush**

Pennello per alimenti  
Kuchenpinsel  
Pinceaux à pâtissier  
Pincel de cocina

art.	cm.	U. Pack
47645-40	4	6
47645-60	6	6
47645-75	7,5	6

**Natural bristles. – Setole naturali.**



PA

**Pastry brush**

Pennello per alimenti  
Kuchenpinsel  
Pinceaux à pâtissier  
Pincel de cocina

art.	cm.	U. Pack
47646-40	4	6
47646-60	6	6
47646-75	7,5	6

**Polyester bristles. – Setole in poliestere.**



PP

**Set 10 dough scrapers**

Set 10 raschietti  
Teigschaber, 10 Stk.  
Set 10 raclettes  
Conjunto 10 rasquetas

art.	dim. mm.
47621-01	216x128



PP

**Set 10 dough scrapers**

Set 10 raschietti  
Teigschaber, 10 Stk.  
Set 10 raclettes  
Conjunto 10 rasquetas

art.	dim. mm.
47621-02	120x86



PP

**Set 10 dough scrapers**

Set 10 raschietti  
Teigschaber, 10 Stk.  
Set 10 raclettes  
Conjunto 10 rasquetas

art.	dim. mm.
47621-03	120x88



PP

**Set 10 dough scrapers**

Set 10 raschietti  
Teigschaber, 10 Stk.  
Set 10 raclettes  
Conjunto 10 rasquetas

art.	dim. mm.
47621-04	121x81



PP

**Set 10 dough scrapers**

Set 10 raschietti  
Teigschaber, 10 Stk.  
Set 10 raclettes  
Conjunto 10 rasquetas

art.	dim. mm.
47621-05	148x99



PP

**Set 10 decorating combs**

Set 10 pettini decoratori  
Dekorationskamm, 10 Stk.  
Set 10 peignes à decor  
Conjunto 10 peines decoradores

art.	dim. mm.
47621-06	145x99



PP

**Set 10 decorating combs**

Set 10 pettini decoratori  
Dekorationskamm, 10 Stk  
Set 10 peignes à decor  
Conjunto 10 peines decoradores

art. dim. mm.  
47621-07 110x80



PP

**Set 10 decorating combs**

Set 10 pettini decoratori  
Dekorationskamm, 10 Stk  
Set 10 peignes à decor  
Conjunto 10 peines decoradores

art. dim. mm.  
47621-08 216x128



SS

**Set 3 decorating combs**

Set 3 pettini decoratori  
Dekorationskamm, 3 Stk  
Set 3 peignes à decor  
Conjunto 3 peines decoradores

art. dim. mm.  
47625-03 100x100



SS

**Sugar dredger**

Spargi zucchero  
Zuckerstreuer  
Glacière à sucre  
Dosificador para azúcar

art. Ø cm. h. cm.  
47022-12 7 9



PP

**Moisture bottle**

Flacone per bagno  
Sprühflasche  
Bouteille à puncher  
Frasco nebulizador

art. dim. cm. lt.  
47679-10 10x5,6x27,5 1



PP

**Spraying bottle**

Flacone nebulizzatore  
Sprühflasche  
Bouteille à puncher spray  
Frasco nebulizador

art. dim. cm. lt.  
47679-11 7x7x30 1



SS

**Flour sifter**

Setaccio farina  
Einhand-Drücksieb  
Tamiseur farine  
Tamiz para harina

art. Ø cm. gr.  
42607-05 12 500



**Icing sugar sieve**

Setaccio per zucchero a velo  
Sieb für Puderzucker  
Tamis à sucre glace  
Cedazo para azúcar glas

art. Ø cm. h. cm.  
47614-25 23 8



**Sieve for flour**

Setaccio rete farina  
Sieb für Mehl  
Tamis pour farine  
Cedazo para harina

art. Ø cm. h. cm.  
47615-25 23 8



**Flour brush**

Spazzola per farina  
Mehlbürste  
Brosse à pétrin  
Cepillo para harina

art. cm.  
42614-21 30

Horse hair. – Setole di cavallo.



SS

**Display tray**

Vassoio espositore  
Auslegeplatte  
Plat patissier  
Bandeja pastelería

art. dim. cm.  
47075-20 20x16x1  
47075-30 30x21x1  
47075-45 45x34x1



SS

**Display tray**

Vassoio espositore  
Auslegeplatte  
Plat patissier  
Bandeja pastelería

art. dim. cm.  
42533-23 23x16,5x0,5  
42533-26 26x19,5x0,5  
42533-31 31x24x0,5  
42533-36 36x28,5x0,5  
42533-40 40x32,5x0,5



**Display tray, aluminum**

Vassoio espositore, alluminio  
Auslegeplatte, Aluminium  
Plat patissier, alu  
Bandeja pastelería, aluminio

art.	dim. cm.
47070-37	37,5x24,5x1
47070-48	48x31x1
47070-60	60x40x1



SS

Vassoio espositore  
Auslegeplatte  
Plat patissier  
Bandeja pastelería

art.	dim. cm.
47074-01	30x20x1,5
47074-02	40x10x1,5
47074-03	40x20x1,5
47074-04	40x30x1,5



SS

Vassoio espositore  
Auslegeplatte  
Plat patissier  
Bandeja pastelería

art.	dim. cm.
47074-05	50x10x1,5
47074-06	60x6x1,5
47074-07	60x10x1,5
47074-08	60x20x1,5



**Baking paper, siliconized**

Carta da forno siliconata  
Baktrennfolie, silikonisiert  
Feuille de cuisson, siliconée  
Papel de horno siliconado

art.	dim. cm.	pcs/pz
47682-53	53x32,5	500
47682-60	60x40	500

**Artificial parchment, bleached, g/m<sup>2</sup>: 41,0, both sides siliconized, reusable, for all kinds of dough.** – Pergamena artificiale, sbiancata, g/m<sup>2</sup>: 41,0, siliconata fronte/retro, riutilizzabile, idonea per tutti i tipi di pasta.



**Baking paper, PTFE coated**

Carta da forno, rivestimento PTFE  
Baktrennfolie, PTFE-beschichtet  
Feuille de cuisson, revêtement PTFE  
Papel de horno anti-adherente

art.	dim. cm.	U. Pack
47681-60	60x40	10

**Fiberglass tissue coated on both sides, can be used up to 500 times, tear-proof. Carefully dry after use.**

Tessuto fibra di vetro rivestito fronte/retro, resistente alla trazione, antiaderente, riutilizzabile più di 500 volte. Asciugare dopo l'uso.



**Baking sheet, silicone, microperforated**

Tappeto silicone microforato  
Silikonbackmatte, microperforiert  
Tapis cuisson en silicone, microperforé  
Tapete de cocción silicona, microperforado

art.	GN	dim. cm.
47691-53	1/1	53x32,5
47691-64	-	60x40



**Baking sheet, silicone**

Tappeto silicone  
Silikonbackmatte  
Tapis cuisson en silicone  
Tapete de cocción silicona

art.	GN	dim. cm.
47689-53	1/1	53x32,5
47689-60	-	60x40



SILPAT – SILPAIN – ROUL’PAT



**SILPAT:** Non-stick sheet ideal for backing brioches and buns as well as any kind of sweet bread backed in sheets. **Ideal also for working sugar. SILPAIN:** Non-stick perforated sheet ideal for baking bread and tarts. **ROUL’PAT:** The silicone coating on both sides prevents the sheet from slipping. Perfect to prepare any type of dough and it also enables to easily prepare macaroon.

SILPAT: Antiaderente ideale per la cottura di tutte le viennoiseries e tutti i tipi di pasticceria da panetteria cotti in teglie. Ideale anche per la lavorazione dello zucchero. SILPAIN: Antiaderente areato ideale per la cottura di pani e la cottura in bianco di fondi per crostate. ROUL’PAT: Con il rivestimento in silicone su entrambi i lati, non scivola sul piano di lavoro. Permette di lavorare ogni tipo di pasta, e con grande facilità anche il croccante.



**SILPAT Silicone baking sheet**

Tappeto silicone  
Silikonbackmatte  
Tapis cuisson en silicone  
Tapete de cocción silicona

art.	GN	dim. cm.
47680-40	-	40x30
47680-53	1/1	53x32,5
47680-60	-	60x40



**SILPAIN Silicone baking sheet**

Tappeto silicone  
Silikonbackmatte  
Tapis de cuisson en silicone  
Tapete de cocción silicona

art.	GN	dim. cm.
47685-53	1/1	53x32,5
47685-60	-	60x40



**ROUL’PAT Silicone baking sheet**

Tappeto silicone  
Silikonbackmatte  
Tapis de cuisson en silicone  
Tapete de cocción silicona

art.	dim. cm.
47688-60	60x40



**Baking beans, ceramic**

Noccioli di cottura, ceramica  
Backkerne, Keramik  
Noyaux de cuisson, céramique  
Núcleos de cocción, cerámica

art.	Kg.
47011-01	1



**Acetate sheets**

Acetato in fogli  
Acetat Band-Blätter  
Feuilles en acétate  
Hojas de acetato

art.	my	dim. cm.	pcs/pz
47131-30	90	30x30	50
47131-60	90	60x40	50

**Ribbons and sheets to coat molds, to make and unmold single portions and mignons. Non-stick for food use. Suitable for cooling in blast chiller, freezer and fridge, not suitable for cooking. Extra transparent, super resistant.**



**Cake ribbon (PET)**

Nastro per dolci  
Tortenrandband  
Ruban pâtissier  
Cinta para tartas

art.	my	h. cm.	mt.
47130-25	90	2,5	305
47130-30	90	3,0	305
47130-35	90	3,5	305
47130-40	90	4,0	305
47130-45	90	4,5	305
47130-50	90	5,0	305
47130-55	90	5,5	305
47130-60	90	6,0	305

**Nastri e fogli per rivestire stampi, per realizzare e sfornare monoporzioni e mignon. Antiaderenti per uso alimentare. Adatti al raffreddamento in abbattitore, congelatore e frigo, non adatti alla cottura. Extra trasparenti, super resistenti.**



SS

**Tart ring**

Anello per torte  
Tortenring  
Cercle à tarte  
Anillo para tartas

art.	Ø cm.	h. cm.
47533-07	7	2
47533-08	8	2
47533-09	9	2
47533-10	10	2
47533-12	12	2
47533-14	14	2
47533-16	16	2
47533-18	18	2
47533-20	20	2
47533-22	22	2
47533-24	24	2
47533-26	26	2
47533-28	28	2
47533-30	30	2
47533-32	32	2



SS

**Tart ring**

Anello per torte  
Tortenring  
Cercle à tarte  
Anillo para tartas

art.	Ø cm.	h. cm.
47530-14	14	3,5
47530-16	16	3,5
47530-18	18	3,5
47530-20	20	3,5
47530-22	22	3,5
47530-24	24	3,5
47530-26	26	3,5
47530-28	28	3,5
47530-30	30	3,5



SS

**Mousse ring**

Anello per mousse  
Schaumspeisenring  
Cercle à mousse  
Anillo para mousse

art.	Ø cm.	h. cm.
47532-06	6,0	4,0
47532-07	7,5	4,0
47532-08	8,0	4,5
47532-12	12,0	4,5
47532-14	14,0	4,5
47532-16	16,0	4,5
47532-18	18,0	4,5
47532-20	20,0	4,5
47532-22	22,0	4,5
47532-24	24,0	4,5
47532-26	26,0	4,5



SS

**Ice cream cake ring**

Anello per torte gelato  
Eistortenring  
Cercle à vacherin  
Circulo alto

art.	Ø cm.	h. cm.
47534-07	7	9
47534-08	9	9
47534-09	7	11
47534-10	9	11



SS

**Ice cream cake ring**

Anello per torte gelato  
Eistortenring  
Cercle à vacherin  
Circulo alto

art.	Ø cm.	h. cm.
47534-00	8	6
47534-01	10	6



SS

**Ice cream cake ring**

Anello per torte gelato  
Eistortenring  
Cercle à vacherin  
Circulo alto

art.	Ø cm.	h. cm.
47534-06	6	6
47534-16	16	6
47534-18	18	6
47534-20	20	6
47534-22	22	6
47534-24	24	6
47534-26	26	6
47534-28	28	6



SS

**Cake setting ring, flexible**

Anello regolabile, flessibile  
Tortenring, verstellbar, flexible  
Cercle à tarte réglable, flexible  
Anillo ajustable, flexible

art.	Ø cm.	h. cm.
47529-07	16,5>32	7

**MICROPERFORATED CAKE RINGS**  
FASCE MICROFORATE

SS



The micro-holes allow to support the edges of the cake avoiding to collapse during cooking. They also allow to expel the moisture from the dough, obtaining a perfect and always crispy cooking.

I microfori permettono di sostenere i bordi della torta evitandone il collasso in cottura. Consentono inoltre di espellere l'umidità, ottenendo una cottura sempre perfetta e croccante.



**Cake ring, microperforated**

Fascia microforata

Tarte-Rahmen perforiert

Cercle microperforé

Anillo tarta microperforado

art.	Ø cm.	h. cm.
47510-07	7	3,5
47510-09	9	3,5
47510-11	11	3,5
47510-13	13	3,5
47510-15	15	3,5
47510-17	17	3,5
47510-19	19	3,5
47510-21	21	3,5
47510-23	23	3,5
47510-25	25	3,5
47510-27	27	3,5
47510-29	29	3,5
47510-31	31	3,5



**Cake ring, microperforated**

Fascia microforata

Tarte-Rahmen perforiert

Cercle microperforé

Anillo tarta microperforado

art.	Ø cm.	h. cm.
47511-07	7	2
47511-09	9	2
47511-11	11	2
47511-13	13	2
47511-15	15	2
47511-17	17	2
47511-19	19	2
47511-21	21	2
47511-23	23	2
47511-25	25	2
47511-27	27	2
47511-29	29	2
47511-31	31	2

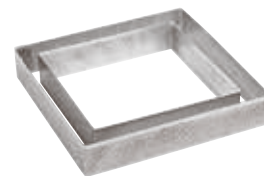

**Cake ring, microperforated**

Fascia microforata

Tarte-Rahmen perforiert

Cercle microperforé

Anillo tarta microperforado

art.	dim. cm.	h. cm.
47512-07	7x7	3,5
47512-09	9x9	3,5
47512-11	11x11	3,5
47512-13	13x13	3,5
47512-15	15x15	3,5
47512-17	17x17	3,5
47512-19	19x19	3,5
47512-21	21x21	3,5
47512-23	23x23	3,5
47512-25	25x25	3,5
47512-27	27x27	3,5
47512-29	29x29	3,5
47512-31	31x31	3,5







SS

**Extensible frame**

Telaio regolabile  
Backrahm, verstellbar  
Bande à tarte réglable  
Marco para tarta, ajustable

art.	Ø cm.	h. cm.
47526-05	30x30>57x56	5



SS

**Extensible frame**

Telaio regolabile  
Backrahm, verstellbar  
Bande à tarte réglable  
Marco para tarta, ajustable

art.	Ø cm.	h. cm.
47528-05	19x28>34x54	5



SS

**Extensible heart frame**

Telaio cuore regolabile  
Herz-Backrahm, verstellbar  
Bande à tarte réglable  
Marco para tarta, ajustable

art.	Ø cm.	h. cm.
47542-00	14,5>26,5	5

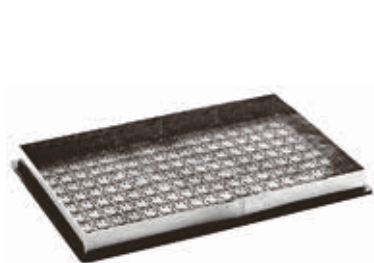

SS

**Rectangle**

Rettangolo  
Rechteck  
Rectangle  
Rectangular

art.	dim. cm.
47527-55	55x35,5x4,5



SS

**Rectangle**

Rettangolo  
Rechteck  
Rectangle  
Rectangular

art.	dim. cm.
47546-18	18x36x5
47546-30	30x40x5
47546-40	40x60x5

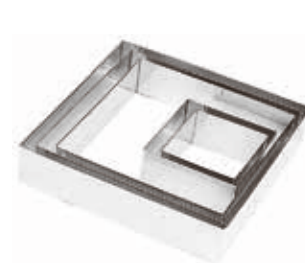

SS

**Square**

Quadrato  
Viereck  
Carré  
Cuadrado

art.	dim. cm.
47548-02	10x10x4,5
47548-03	18x18x4,5
47548-04	20x20x4,5
47548-05	22x22x4,5



SS

**Rounded square**

Quadrato bombato  
Viereck, konvex  
Carré arrondi  
Cuadrado abombado

art.	dim. cm.
47541-02	10x10x4,5
47541-03	18x18x4,5
47541-04	20x20x4,5



SS

**Oval**

Ovale  
Oval  
Ovale  
Oval

art.	dim. cm.
47547-22	24,5x20x4
47547-26	30x23x4
47547-30	33x26,5x4



SS

**Comma**

Virgola  
Komma  
Virgule  
Coma

art.	Ø cm.	h. cm.
47544-20	20	4
47544-25	25	4
47544-30	30	4





SS

**Heart**  
Cuore  
Herz  
Coeur  
Corazón

art.	Ø cm.	h. cm.
47542-18	18	4
47542-20	20	4
47542-22	22	4
47542-24	24	4
47542-26	26	4



SS

**Triangle**  
Triangolo  
Dreieck  
Triangle  
Triángulo

art.	Ø cm.	h. cm.
47540-02	12	4,5
47540-03	20	4,5
47540-04	22	4,5
47540-05	24	4,5



SS

**Triangle**  
Triangolo  
Dreieck  
Triangle  
Triángulo

art.	Ø cm.	h. cm.
47538-20	20	4
47538-23	23	4
47538-26	26	4

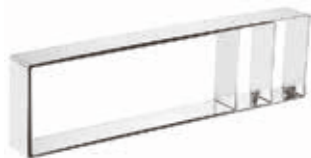

SS

**Rectangle**  
Rettangolo  
Rechteck  
Rechteck  
Rectangle  
Rectangular

art.	dim. cm.
47546-21	25x9x2
47546-22	30x9,1x2
47546-23	35x9,2x2

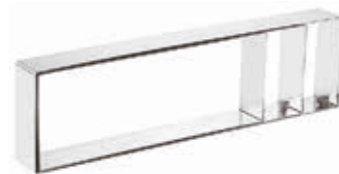

SS

**Rectangle**  
Rettangolo  
Rechteck  
Rechteck  
Rectangle  
Rectangular

art.	dim. cm.
47546-41	25x9x4
47546-42	30x9,1x4
47546-43	35x9,2x4

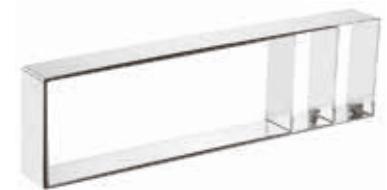

SS

**Rectangle**  
Rettangolo  
Rechteck  
Rechteck  
Rectangle  
Rectangular

art.	dim. cm.
47546-51	25x9x5
47546-52	30x9,1x5
47546-53	35x9,2x5

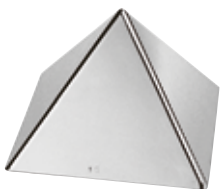

SS

**Pyramid**  
Piramide  
Pyramide  
Piramide  
Pirámide

art.	dim. cm.	h. cm.
47535-09	9x9	6
47535-12	12x12	8
47535-15	15x15	10
47535-17	17x17	12
47535-19	19x19	13



SS

**Half sphere**  
Semi-sfera  
Halbkugel  
Demi-sphère  
Semiesfera

art.	Ø cm.	h. cm.
47536-12	12	6
47536-14	14	7
47536-16	16	8
47536-18	18	9
47536-20	20	10



SS

**Crème caramel**  
Crème caramel  
Crème caramel  
Crème caramel  
Molde para flan

art.	Ø cm.	h. cm.	ml.
41660-10	7	5	150
41660-15	7	6	180





**Piepan, aluminum**

Tortiera, alluminio  
Tortenform, Aluminium  
Tourtière, alu  
Molde, aluminio

art.	Ø cm.	h. cm.
16940-28	28	5,0
16940-32	32	5,5
16940-36	36	6,0
16940-40	40	6,5



**Savarin tin, aluminum**

Ciambella, alluminio  
Savarinform, Aluminium  
Moule à savarin, alu  
Molde para savarin, aluminio

art.	Ø cm.	h. cm.	U. Pack
47060-06	6,0	2,5	3
47060-07	7,5	3,0	3
47060-09	9,0	3,5	3
47060-10	10,0	3,5	3
47060-12	12,0	5,5	3
47060-14	14,0	5,5	3
47060-16	16,0	5,5	3
47060-18	18,0	6,5	3
47060-20	20,0	6,5	3
47060-22	22,0	6,5	3
47060-24	24,0	8,5	3
47060-26	26,0	8,5	3
47060-30	30,0	8,5	3



**Pandoro mold, aluminum**

Stampo pandoro, alluminio  
Pandoro-Form, Aluminium  
Moule à pandoro, aluminium  
Molde pandoro, aluminio

art.	gr.
47063-01	100
47063-02	250
47063-05	500
47063-07	750
47063-10	1000



**Gugelhupf, aluminum**

Stampo americano, alluminio  
Gugelhupfppform, Aluminium  
Moule à gugelhupf, alu  
Molde gugelhupf, aluminio

art.	Ø cm.	h. cm.
47062-18	18	10,5
47062-20	20	11,0
47062-22	22	12,0



**Plumcake, aluminum**

Plumcake, alluminio  
Plumcake, Aluminium  
Plumcake, alu  
Molde para plumcake, aluminio

art.	dim. cm.
47064-18	18x80x6
47064-22	22x90x7
47064-26	26x10x8
47064-30	30x11x9



**Beaker shaped tin, aluminum**

Stampo per babà, alluminio  
Timbalforn, Aluminium  
Moule à dariole, alu  
Molde, aluminio

art.	Ø cm.	h. cm.	U. Pack
47066-03	3	3,5	10
47066-04	4	4,5	10
47066-05	5	5,5	10
47066-06	6	6,0	10
47066-07	7	7,0	10
47066-08	8	8,0	10



**Crème caramel, aluminum**

Crème caramel, alluminio  
Crème caramel, Aluminium  
Crème caramel, alu  
Molde crème caramel, aluminio

art.	Ø cm.	h. cm.	U. Pack
41659-06	6	4,8	6
41659-07	7	5,0	6
41659-08	8	5,3	6



**Cassata mold, aluminum**

Stampo cassata, alluminio  
Cassataform, Aluminium  
Moule à cassata, alu  
Molde para cassata, aluminio

art.	Ø cm.	h. cm.
47068-12	12	10
47068-15	15	12



**Zuccotto mold, aluminum**

Stampo per zuccotto, alluminio  
Zuccottoform, Aluminium  
Moule à zuccotto, alu  
Molde para zuccotto, aluminio

art.	Ø cm.
47069-10	10
47069-12	12
47069-14	14
47069-16	16
47069-18	18
47069-20	20

**MODULAR SYSTEM BASE=LID EXTENSIBLE HEIGHT**  
**SISTEMA MODULARE BASE=COPERCHIO ALTEZZA ESTENSIBILE**



Modular system, the base and lid are the same element and due to the extender insert it is possible to increase capacity. Equipped with rotation system that allows steam to escape. On request dimensions 80x80 cm.

Sistema modulare, base e coperchio sono lo stesso elemento e grazie all'inserto estensore è possibile aumentare la capacità. Provvisto di sistema rotabile, per la fuoriuscita del vapore. A richiesta nelle dimensioni 80x80 cm.



**Base and lid**

Base e coperchio  
 Basis und Abdeckung  
 Base et couvercle  
 Base y tapa

art.	cm. ext.	cm. int.
44975-35	41x41x7,5	35,2x35,2x4,5
44975-50	57x57x9,5	51x51x6,3

**Extender**

Estensore  
 Aufsatz  
 Réhausse  
 Extensión

art.	cm. ext.	cm. int.
44975H35	41x41x7,5	35,2x35,2x7,5
44975H50	57x57x9,5	51x51x7,5x9,5



# NON STICK CAKE MOLDS TORTIERE ANTIADERENTI

PASTRY  
PASTICCERIA



Wash the mold before the first use. Slightly grease inside surface with oil, butter or margarine before baking. Allow cake to cool down a little before removing from the mold. For the cleaning, hand-wash with dish soap and dry the mold immediately after washing. Use only in traditional ovens (no microwave). Do not use sharp objects or others metal tools which could damage the pan surface. Do not use on a flame or other direct heat source, including stove tops. Do not exceed 230°C. Non-stick coating PFOA free.

Lavare lo stampo prima di utilizzarlo la prima volta. Ungere leggermente l'interno con olio, burro o margarina prima di infornare. Prima di sfornare, lasciare raffreddare per qualche minuto. Lavare a mano con detersivi liquidi ed asciugare lo stampo immediatamente dopo. Utilizzare esclusivamente in forni tradizionali (no microonde). Non utilizzare oggetti appuntiti, polveri abrasive o pagliette metalliche che possano rigare la superficie degli stampi. Evitare il contatto con fonti di calore dirette o fiamma libera. Non superare la temperatura massima di 230°C. Rivestimento antiaderente privo di PFOA.





**Pine mold**

Tortiera pino  
Tannenbaumform  
Tourtière pin

**Molde pino**

art.	dim. cm.
47005-24	17x24x8,5



**Star mold**

Tortiera stella  
Sternform  
Tourtière étoile

**Molde estrella**

art.	dim. cm.
47006-25	25x25x4,5



**Crispy tart pan**

Tortiera forata  
Tortenform, gelocht  
Tourtière perforée

**Molde perforado**

art.	Ø cm.	h. cm.
41729-30	29/27	1,5
41729-34	33/30	1,5



**Round cake tin**

Tortiera tonda  
Tortenform, rund  
Tourtière ronde

**Molde redondo**

art.	Ø cm.	h. cm.	U. Pack
47739-12	12	2,1	6
47739-24	24	2,3	1
47739-28	28	2,3	1
47739-32	32	2,5	1



**Round cake tin**

Tortiera tonda  
Tortenform, rund  
Manqué rond uni

**Molde redondo**

art.	Ø cm.	h. cm.
47710-12	12	3,0
47710-16	16	4,0
47710-20	20	4,5
47710-24	24	5,0
47710-28	28	5,0
47710-32	32	5,5



**Round mold, fluted edges**

Tortiera festonata  
Runde Obsttortenform  
Tourtière ronde bord cannelé

**Molde rizado**

art.	Ø cm.	h. cm.
47709-20	20	2,5
47709-24	24	2,5
47709-28	28	2,5
47709-32	32	2,5



**Round mold, fluted, loose bottom**

Tortiera festonata, fondo mobile  
Tortenform, gewellter Rand, Heheboden  
Tourtière cannelée, fond amovible

**Molde acanalado, rizado, fondo desmontable**

art.	Ø cm.	h. cm.
47712-20	20	2,5
47712-24	24	2,5
47712-28	28	2,5
47712-32	32	2,5



**Savarin tin**

Ciambella  
Savarinform  
Moule pour savarin

**Molde Savarin**

art.	Ø cm.	h. cm.	U. Pack
47711-08	8	2,0	6
47711-12	12	2,5	6
47711-22	22	4,5	1
47711-24	24	5,0	1
47711-26	26	6,2	1



**Trois Frères cake ring**

Tortiera trois frères  
Frankfurter Kranzform  
Tourtière trois frères

**Molde trois frères**

art.	Ø cm.	h. cm.
47713-22	22	5,5





**Gugelhupf cake pan**

Stampo americano  
Gugelhupfform  
Moule à gugelhupf  
Molde gugelhupf

art.	Ø cm.	h. cm.
47705-22	22	10



**Loaf pan**

Tortiera rettangolare  
Königskuchenform  
Cake embouti  
Molde rectangular

art.	dim. cm.
47714-26	26x9,5x7,5
47714-28	28x10x7,5



**Rectangular mold, loose plate bottom**

Tortiera, fondo mobile  
Backform, gerippt, Heheboden  
Tourtière cannelée, fond amovible  
Molde fondo desmontable

art.	dim. cm.
47717-35	35x11x2,5



**Square mold, fluted, loose bottom**

Tortiera festonata, fondo mobile  
Tortenform, gewellter Rand, Heheboden  
Tourtière carrée, cannelée, fond amovible  
Molde cuadrado, rizado, fondo desmontable

art.	dim. cm.
47738-23	23x23x2,5



**Baking mold Daisy**

Tortiera margherita  
Margheriten-Backform  
Moule à marguerite  
Molde margarita

art.	Ø cm.	h. cm.
47718-20	20	6



**Round mold, fluted, loose bottom**

Tortiera festonata, fondo mobile  
Tortenform, gewellter Rand, Heheboden  
Tourtière cannelée, fond amovible  
Molde acanalado, fondo desmontable

art.	Ø cm.	h. cm.	U. Pack
47719-10	10	3	6
47719-24	25	5	1



**Round mold, fluted, loose bottom**

Tartelletta festonata, fondo mobile  
Runde, gewellte Tortellets, Heheboden  
Tartelette ronde cannelée, fond amovible  
Molde redondo rizado, fondo desmontable

art.	Ø cm.	h. cm.	U. Pack
47758-10	10	1,8	6
47758-12	12	2,0	6



**Charlotte mold**

Charlotte  
Charlotte-Form  
Charlotte  
Molde Charlotte

art.	Ø cm.	h. cm.	U. Pack
47734-18	18	10	6



**Bavarois mold**

Bavarese  
Bayerische-Kuchenform  
Moule Bavarois  
Molde Bávaro

art.	Ø cm.	h. cm.
47735-18	18	9



**Rectangular cake mold**

Tortiera rettangolare  
Königskuchenform  
Cake évasé  
Molde ensanchado

art.	dim. cm.
47733-18	18x7,5x6,5
47733-24	24x9x7,5
47733-30	30x10x8
47733-36	36x10,5x8



**Folding loaf pan**

Tortiera rettangolare apribile  
Aufklappbare-Königskuchenform  
Cake ouvrant  
Molde rectangular desmontable

art.	dim. cm.
47715-30	30x10x7,5





**Loaf pan with hinges, loose bottom**  
Bacinella paté con cerniera, fondo mobile  
Springkastenform, Hebeboden  
Pâté à charnière, fond démontable  
Molde con bisagra, fondo desmontable

art.	dim. cm.
47736-30	30x8x8
47736-35	35x8x8
47736-40	40x8x8
47736-50	50x8x8



**Mini paté mold**  
Stampo mini-paté  
Pastetenkastenform  
Mini-pâté à croûte  
Molde minipaté

art.	dim. cm.
47018-30	30x4x6
47018-50	50x4x6



**Loaf pan**  
Stampo carré  
Königskuchenform  
Cake évasé  
Molde ensanchado

art.	dim. cm.
47752-09	9x6x3,4
47752-16	14x6,5x4
47752-21	17x9,5x5,5



**Fluted loaf pan**  
Stampo carré, fondo festonato  
Königskuchenform, gerippt  
Cake évasé, fond cannelé  
Molde ensanchado, fondo rizado

art.	dim. cm.
47753-31	31x12x5



**Baguette baking pan**  
Teglia baguettes  
Baguetteform  
Plaque à baguettes  
Placa para baguettes

art.	dim. cm.
47014-35	35x24,5x2,5



**Oval aspic mold**  
Aspic ovale  
Ovale Aspickform  
Aspic ovale  
Molde oval

art.	dim. cm.	U. Pack
47726-07	7,5x5,5x3,8	6



**Oval aspic mold, star bottom**  
Aspic ovale, fondo stella  
Ovale Aspickform, Sternboden  
Aspic ovale, étoilé  
Molde oval, fondo estrella

art.	dim. cm.	U. Pack
47727-07	7,5x5,5x3,8	6



**Rum baba mold**  
Stampo babà  
Runde Babaform  
Dariole embouti  
Molde para babà

art.	Ø cm.	h. cm.	U. Pack
47728-06	6	6	6



**Wine leaf tart mold**  
Tartelletta foglia di vite  
Törtchenform Weinblatt  
Tartelette feuille vigne  
Molde pasteles

art.	Ø mm.	h. cm.	U. Pack
47760-12	12	2	6



**Oak leaf tart mold**  
Tartelletta foglia di quercia  
Törtchenform Eichenblatt  
Tartelette feuille chêne  
Molde pasteles

art.	Ø cm.	h. cm.	U. Pack
47759-12	12	2	6



**Savarin mold**  
Tartelletta savarin  
Savarinförmchen  
Savarin  
Molde savarin

art.	Ø mm.	h. cm.	U. Pack
47757-65	6,5	1,5	6
47757-80	8,0	2,0	6



**Oval boat mold**  
Tartelletta barchetta  
Schiffchenförmchen  
Barquette unie  
Molde barquilla

art.	dim. cm.	U. Pack
47720-06	6x2x1	6
47720-08	8x3,3x1,2	6
47720-10	10x4,3x1,3	6
47720-12	12x5x1,3	6





**Fluted oval boat mold**

Tartelletta barchetta, festonata  
Schiffchenförmchen, gerippt  
Barquette, cannelée  
Molde barquilla, rizado

art.	dim. cm.	U. Pack
47721-08	8x4x1,2	6
47721-10	10x4,5x1,2	6
47721-12	12x5x1,4	6



**Round plain mold**

Tartelletta tonda  
Backförmchen, rund  
Tartelette ronde, unie  
Molde redondo

art.	Ø cm.	U. Pack
47722-05	5	6
47722-06	6	6
47722-07	7	6
47722-08	8	6
47722-10	10	6



**Round fluted mold**

Tartelletta tonda festonata  
Backförmchen, rund, gerippt  
Tartelette ronde, cannelée  
Molde redondo, rizado

art.	Ø cm.	U. Pack
47723-05	5	6
47723-06	6	6
47723-07	7	6
47723-08	8	6
47723-10	10	6
47723-12	12	6



**Brioche mold**

Tartelletta a brioche  
Brioche-Förmchen  
Tartelette brioche  
Molde brioche

art.	Ø cm.	U. Pack
47724-06	6	6
47724-08	8	6
47724-10	10	6
47724-11	11	6



**Box of small assorted molds**

Scatola tartellette assortite  
Satz Förmchen  
Boîte petits fours, assortis  
Surtido moldes

art.	pcs/pz
47730-60	60



**Friand mold**

Tartelletta rettangolare  
Friand-Förmchen  
Friand  
Molde rectangular

art.	dim. cm.	U. Pack
47725-09	10x5x1,4	6



**Small mold**

Tartelletta  
Törtchenform  
Petit four  
Molde pasteles

art.	dim. cm.	U. Pack
47747-03	4,5x3	6

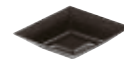

**Small mold**

Tartelletta  
Törtchenform  
Petit four  
Molde pasteles

art.	dim. cm.	U. Pack
47747-06	6x3	6



**Small mold**

Tartelletta  
Törtchenform  
Petit four  
Molde pasteles

art.	Ø cm.	h. cm.	U. Pack
47747-10	4,0	1,0	6
47747-11	3,5	1,4	6



**Small mold**

Tartelletta  
Törtchenform  
Petit four  
Molde pasteles

art.	Ø cm.	U. Pack
47747-01	4,5	6



**Small mold**

Tartelletta  
Törtchenform  
Petit four  
Molde pasteles

art.	dim. cm.	U. Pack
47747-04	3,5x3,5	6





**Small mold**  
Tartelletta  
Törtchenform  
Petit four  
Molde pasteles

art.	dim. cm.	U. Pack
47747-07	6x3	6



**Small mold**  
Tartelletta  
Törtchenform  
Petit four  
Molde pasteles

art.	Ø cm.	U. Pack
47723-05	5	6



**Small mold**  
Tartelletta  
Törtchenform  
Petit four  
Molde pasteles

art.	dim. cm.	U. Pack
47747-05	4,5x2,5	6



**Small mold**  
Tartelletta  
Törtchenform  
Petit four  
Molde pasteles

art.	dim. cm.	U. Pack
47747-09	5x3	6



**Madeleine sheet**  
Stampo per madeleines  
Madeleine-Backblech  
Plaque madeleines  
Molde Madeleine

art.	dim. cm.
47731-12	26x20

**Pcs/Pz 12 - 7x4,2 cm.**



**Madeleinette sheet**  
Stampo per madeleinettes  
Madeleinette-Backblech  
Plaque madeleinettes  
Molde Madeleine

art.	dim. cm.
47732-20	39,5x12,5

**Pcs/Pz 20 - 4,2x3 cm.**



**Cup bun pan**  
Stampo tartellette  
Backblech  
Plaque tartelettes  
Molde pasteles

art.	Ø cm.	dim. cm.
47748-35	6,5	35,5x27x2,5



**Snowman mold**  
Stampo pupazzo di neve  
Schneemann-Backblech  
Plaque bonhomme de neige  
Molde muñeco de nieve

art.	dim. cm.
47762-23	23x5



**Christmas style mold**  
Stampo di Natale  
Weihnachts-Backblech  
Plaque de Noël  
Molde de Noël

art.	dim. cm.
47750-06	31,5x21,5x2,5



**Santa Claus mold**  
Stampo Babbo Natale  
Weihnachtsmann-Backblech  
Plaque Père Noël  
Molde Papà Noel

art.	dim. cm.
47761-23	23x4,8



**Easter muffin pan**  
Stampo motivi pasquali  
Ostern-Backblech  
Plaque Pâque  
Molde Pascua

art.	dim. cm.
47749-35	35x27x3



**Egg mold**  
Stampo uovo  
Ostereierform  
Moule à oeuf  
Molde para huevos

art.	dim. cm.
47007-26	26x8,3





**Easter rabbit mold**

Stampo coniglietto di Pasqua  
Osternhase-Backblech  
Plaque lapin de Pâque  
Molde conejo de Pascua

art.	dim. cm.
47764-12	12x2,6



**Easter rabbit mold**

Stampo coniglio di Pasqua  
Osternhase-Backblech  
Plaque lapin de Pâque  
Molde conejo de Pascua

art.	dim. cm.
47764-28	28x5,4



**Fluted springform pan**

Stampo ciambella apribile  
Savarinspringform  
Manqué savarin démontable  
Molde savarin desmontable

art.	Ø cm.	h. cm.
47756-20	20,5	4,7
47756-24	24,0	6,8
47756-26	26,0	6,5
47756-28	28,0	6,7



**Springform mold with 6 bottoms**

Stampo apribile, 6 fondi  
Springform mit 6 Böden  
Manqué démontable, 6 fonds  
Molde desmontable, 6 fondos

art.	Ø cm.	h. cm.
47755-26	26	6



**Springform mold**

Stampo apribile  
Springform  
Manqué démontable  
Molde desmontable

art.	Ø cm.	h. cm.
47754-20	20,5	6,5
47754-24	24,0	6,5
47754-26	26,0	6,5
47754-28	28,0	6,7

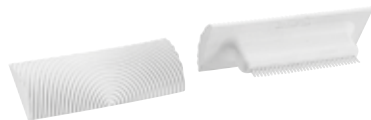

**Rubber comb, wood effect**

Tampone finto legno  
Kamm aus Kunststoff, holzartig  
Peigne faux bois  
Peine de goma, efecto madera

art.	cm.
47684-15	15



**Log mold, plastic**

Stampo per tronco, plastica  
Kastenform, Kunststoff  
Gouttière, plastique  
Molde, plástico

art.	dim. cm.
47659-01	48x6,5x7
47659-02	48x6,5x7
47659-03	48x6,5x7
47659-04	48x5,0x4

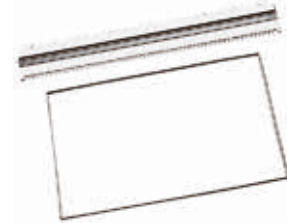

**Comb for Charlotte with frame**

Pettine Charlotte con telaio  
Charlotte-Kamme mit Rahmen  
Peigne à Charlotte avec cadre  
Peine para Charlotte con marco

art.	dim. cm.
47670-02	57x36,5



**Comb with 5 rubber blades**

Pettine con 5 fasce gomma  
Kamm mit 5 Gummiklingen  
Peigne avec 5 bandes à décor  
Peine con 5 láminas de goma

art.	dim. cm.
47672-05	70x10

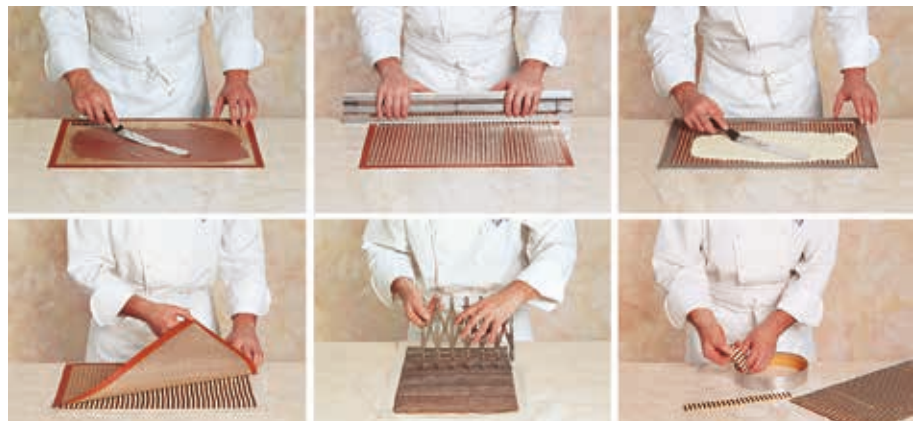

MONOPORTION TRAY MOLDS  
TEGLIE MONOPORZIONI



**Tray cm. 60x40**

Teglia  
Blech  
Plaque  
Bandeja

art.	dim. mm.	gr.	pcs/pz
47651-01	Ø 44 h 25	20	96
47651-02	55x35x25	20	96
47651-03	46x46x25	20	96
47651-04	60x38x25	20	96
47651-05	58x39x25	20	96
47651-07	38x38x25	20	96

**Extractor**

Estrattore  
Extraktor  
Extracteur  
Extractor

art.	dim. mm.
47656-01	Ø 44 h 25
47656-02	55x35x25
47656-03	46x46x25
47656-04	60x38x25
47656-05	58x39x25
47656-07	38x38x25



**Cutter**

Tagliapasta  
Ausstechform  
Coupe-pâte  
Cortador

art.	dim. mm.
47655-01	Ø 44 h 25
47655-02	55x35x25
47655-03	46x46x25
47655-04	60x38x25
47655-05	58x39x25
47655-07	38x38x25

**Tray cm. 60x40**

Teglia  
Blech  
Plaque  
Bandeja

art.	dim. mm.	gr.	pcs/pz
47652-01	Ø 67 h 40	75	35
47652-02	86x50x40	75	35
47652-03	74x71x40	75	35
47652-04	90x58x40	75	35
47652-05	88x60x40	75	35
47652-07	59x59x40	75	35



**Estrattore**

Estrattore  
Extraktor  
Extracteur  
Extractor

art.	dim. mm.
47658-01	Ø 67 h 40
47658-02	86x50x40
47658-03	74x71x40
47658-04	90x58x40
47658-05	88x60x40
47658-07	59x59x40

**Cutter**

Tagliapasta  
Ausstechform  
Coupe-pâte  
Cortador

art.	dim. mm.
47657-01	Ø 67 h 40
47657-02	86x50x40
47657-03	74x71x40
47657-04	90x58x40
47657-05	88x60x40
47657-07	59x59x40







**Stencil cm. 31x51**

art.	dim. cm.	pcs/pz
47875-11	13x3	30



**Stencil cm. 31x51**

art.	dim. cm.	pcs/pz
47875-13	7,5x3,5	40



**Stencil cm. 31x51**

art.	dim. cm.	pcs/pz
47875-14	6,5x4	32

**PRALINE'S SILICONE MOLDS CM 19X29**  
STAMPI IN SILICONE PER PRALINE CM 19X29



**Practical, flexible and resistant silicone molds for sweet or salty creations (snaks, truffles, jellies, pralines). Perfect to make large quantities in short time. They withstand from -40° to +250°C. Can be used in the oven, refrigerator and blast chiller.**

Pratici stampi in silicone flessibili e resistenti per creazioni dolci o salate (snack, tartufi, gelatine, praline). Ideali per realizzare grandi quantità in poco tempo. Resistono da -40° a +250°C. Utilizzabili in forno, frigorifero e abbattitore.

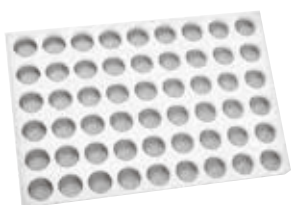

**Chocoflex - psc/pz 54**

art.	Ø mm.	h.
47783-01	26	14

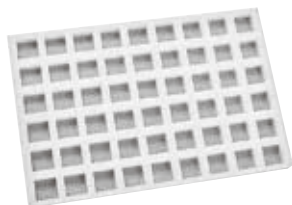

**Chocoflex - psc/pz 54**

art.	dim. mm.
47783-02	23x23x14

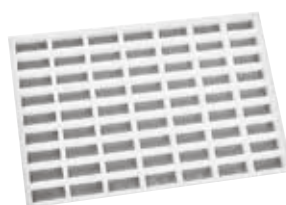

**Chocoflex - psc/pz 63**

art.	dim. mm.
47783-03	35x14,5x14



**Chocoflex - psc/pz 49**

art.	dim. mm.
47783-04	32x21x14

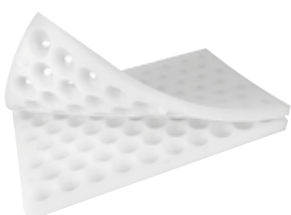

**Chocoflex - psc/pz 54**

art.	Ø mm.	h.
47783-11	26	14



**Chocoflex - psc/pz 40**

art.	Ø mm.	h.
47783-12	30-10	12



**Chocoflex - psc/pz 15**

art.	dim. mm.
47783-13	90x30x19



**Chocoflex - psc/pz 15**

art.	dim. mm.
47783-14	90x30x19



CHOCOLATE  
CIOCCOLATO

PC

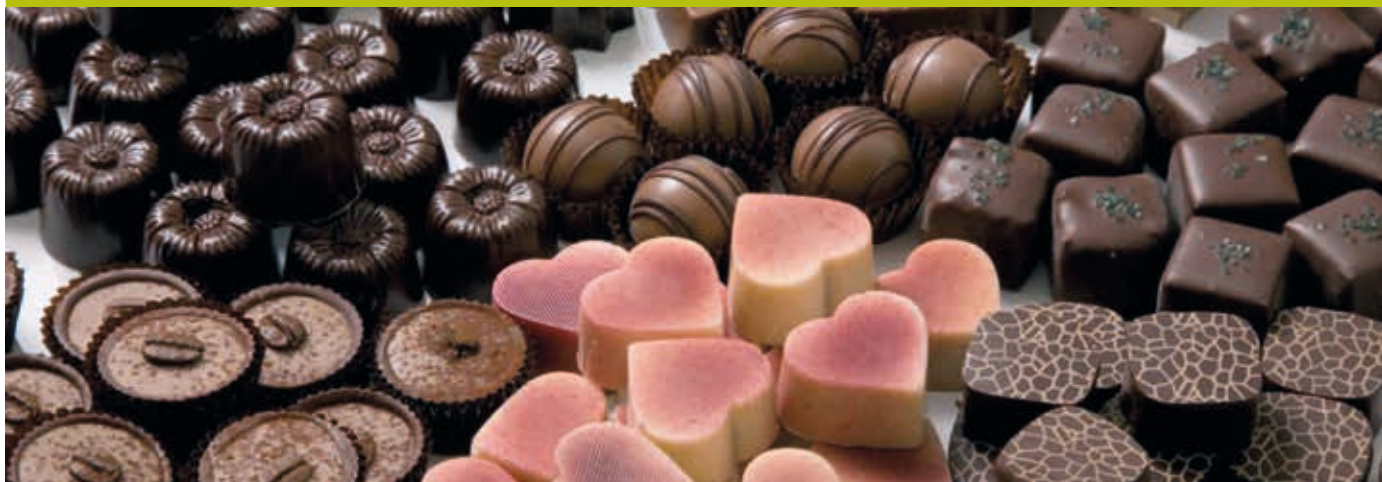

Polycarbonate chocolate molds. Mold size 17,5x27,5 cm.

Stampi policarbonato. Misure stampo 17,5x27,5 cm.



Chocolate/Ciocolato Praline

art.	dim. mm.	pcs/pz
47861-02	50x25x15	21



Chocolate/Ciocolato Praline

art.	dim. mm.	pcs/pz
47861-03	30x30x8	24



Chocolate/Ciocolato Praline

art.	Ø mm.	h.	pcs/pz
47861-04	35	8	24



Chocolate/Ciocolato Praline

art.	dim. mm.	pcs/pz
47861-05	33x33x15	24



Chocolate/Ciocolato Praline

art.	dim. mm.	pcs/pz
47861-07	39x18x15,5	30
47861-08	96x22x15,5	10



Chocolate/Ciocolato Praline

art.	dim. mm.	pcs/pz
47861-09	39x18x15,5	30
47861-10	96x22x17	10



Chocolate/Ciocolato Praline

art.	dim. mm.	pcs/pz
47861-11	39x20x16	27
47861-06	96x22x17	10



Chocolate/Ciocolato Praline

art.	dim. mm.	pcs/pz
47861-12	52x26x14	21



Chocolate/Ciocolato Praline

art.	dim. mm.	pcs/pz
47861-13	42x25x6	20



Chocolate/Ciocolato Praline

art.	dim. mm.	pcs/pz
47861-14	123x27x12	8



Chocolate/Ciocolato Praline

art.	dim. mm.	pcs/pz
47861-15	138x72x11	3



Chocolate/Ciocolato Praline

art.	dim. mm.	pcs/pz
47860-17	30x30x12	24





Chocolate/Ciocolato Praline

art.	Ø mm.	h.	pcs/pz
47860-18	27	17	24



Chocolate/Ciocolato Praline

art.	Ø mm.	h.	pcs/pz
47860-21	29	18	24



Chocolate/Ciocolato Praline

art.	dim. mm.	pcs/pz
47860-24	40x42x15	15



Chocolate/Ciocolato Praline

art.	dim. mm.	pcs/pz
47860-27	27x27x13	28



Chocolate/Ciocolato Praline

art.	dim. mm.	pcs/pz
47860-31	33x25x12	24



Chocolate/Ciocolato Praline

art.	Ø mm.	h.	pcs/pz
47860-35	30	19	28



Chocolate/Ciocolato Praline

art.	dim. mm.	h.	pcs/pz
47860-36	25x25x25	25	40



Chocolate/Ciocolato Praline

art.	dim. mm.	pcs/pz
47860-37	36x22x20	36



Chocolate/Ciocolato Praline

art.	dim. mm.	pcs/pz
47860-38	48x18,5x19	16



Chocolate/Ciocolato Praline

art.	dim. mm.	pcs/pz
47860-39	30x18x15	30



Chocolate/Ciocolato Praline

art.	Ø mm.	h.	pcs/pz
47860-40	29	21	40



Chocolate/Ciocolato Praline

art.	dim. mm.	pcs/pz
47860-42	35x23x16	36



Chocolate/Ciocolato Praline

art.	dim. mm.	pcs/pz
47860-43	38x28x18	30



Chocolate/Ciocolato Praline

art.	dim. mm.	pcs/pz
47860-44	28x32x15	32



Chocolate/Ciocolato Praline

art.	dim. mm.	pcs/pz
47860-46	35x20x17	30



Chocolate/Ciocolato Praline

art.	Ø mm.	h.	pcs/pz
47860-48	28	24	40



Chocolate/Ciocolato Praline

art.	Ø mm.	h.	pcs/pz
47860-49	30	22	28



Chocolate/Ciocolato Praline

art.	Ø mm.	h.	pcs/pz
47860-50	26	15	35



Chocolate/Cioccolato Praline

art.	dim. mm.	pcs/pz
47860-53	22x22x22	28



Chocolate/Cioccolato Praline

art.	dim. mm.	pcs/pz
47860-55	26x20x21	28



Chocolate/Cioccolato Praline

art.	Ø mm.	h.	pcs/pz
47860-56	24	21	28



Chocolate/Cioccolato Praline

art.	dim. mm.	pcs/pz
47860-58	17x12x5	130



Chocolate/Cioccolato Praline

art.	Ø mm.	h.	pcs/pz
47860-60	25	18,5	28



Chocolate/Cioccolato Praline

art.	dim. mm.	pcs/pz
47860-61	30x20x17,5	28



Chocolate/Cioccolato Praline

art.	Ø mm.	h.	pcs/pz
47860-62	27	20	30



Chocolate/Cioccolato Praline

art.	Ø mm.	h.	pcs/pz
47860-63	27	20	30



Chocolate/Cioccolato Praline

art.	dim. mm.	pcs/pz
47860-66	25x25x15	30



Chocolate/Cioccolato Praline

art.	dim. mm.	pcs/pz
47860-67	25x25x15	30



Chocolate/Cioccolato Praline

art.	Ø mm.	h.	pcs/pz
47860-68	28	25	40



Chocolate/Cioccolato Praline

art.	dim. mm.	pcs/pz
47860-69	40x20x18	30



Chocolate/Cioccolato Praline

art.	dim. mm.	pcs/pz
47860-73	31x22x22	5x6



Chocolate/Cioccolato Praline

art.	dim. mm.	pcs/pz
47860-71	26x26x20	30



Chocolate/Cioccolato Praline

art.	dim. mm.	pcs/pz
47860-74	32x32x4	24



Chocolate/Cioccolato Praline

art.	dim. mm.	pcs/pz
47860-70	40x18x15	30





Chocolate/Ciocolato Praline

art.	dim. mm.	pcs/pz
47860-75	20x20x16	28



Chocolate/Ciocolato Praline

art.	dim. mm.	pcs/pz
47860-81	30x18x15	30



Chocolate/Ciocolato Praline

art.	dim. mm.	pcs/pz
47860-83	30x30x15	24



Chocolate/Ciocolato Praline

art.	Ø mm.	h.	pcs/pz
47860-84	26	19	35



Chocolate/Ciocolato Praline

art.	dim. mm.	pcs/pz
47860-85	35x22x16	35



Chocolate/Ciocolato Praline

art.	dim. mm.	pcs/pz
47860-95	25x25x13	24



Chocolate/Ciocolato Praline

art.	Ø mm.	h.	pcs/pz
47860-96	35	15	24



Chocolate/Ciocolato Praline

art.	dim. mm.	pcs/pz
47862-31	28x28x16	28



Chocolate/Ciocolato Praline

art.	dim. mm.	pcs/pz
47862-32	24x24x18	28



Chocolate/Ciocolato Praline

art.	dim. mm.	pcs/pz
47862-33	40x42x16	15



Chocolate/Ciocolato Praline

art.	dim. mm.	pcs/pz
47862-34	41x24x20	20



Chocolate/Ciocolato Praline

art.	dim. mm.	pcs/pz
47862-35	30x30x11	28



Chocolate/Ciocolato Praline

art.	dim. mm.	pcs/pz
47862-36	35x23x17	24



Chocolate/Ciocolato Bars

art.	dim. mm.	pcs/pz
47862-38	50x26x3	16



Chocolate/Ciocolato Bars

art.	dim. mm.	pcs/pz
47862-39	74x33x5	12





Polycarbonate molds mm. 275x175. To create small mignon and refined pralines with an original and inviting look.

Stampi in policarbonato mm. 275x175 . Per creare piccoli mignon e raffinate praline dall'aspetto originale e invitante.



Mini choco fill

art.	Ø mm.	h.	pcs/pz
47862-64	27	31	28



Mini choco fill

art.	Ø mm.	h.	pcs/pz
47862-65	37	14	15



Mini choco fill

art.	dim. mm.	pcs/pz
47862-66	27x27x31	28



Mini choco fill

art.	dim. mm.	pcs/pz
47862-67	33x33x14	24



Mini choco fill

art.	dim. mm.	pcs/pz
47862-03	32x24x29	24



Mini choco fill

art.	dim. mm.	pcs/pz
47862-04	44x56x39	12



Mini choco fill

art.	Ø mm.	h.	pcs/pz
47862-05	40	17	15





Mini choco fill

art.	dim. mm.	pcs/pz
47862-06	33x31x20	24



Mini choco fill

art.	dim. mm.	pcs/pz
47862-07	33x33x23	24



Mini choco fill

art.	dim. mm.	pcs/pz
47862-08	44x55x23	12



Mini choco fill

art.	Ø mm.	h.	pcs/pz
47862-09	40	18,5	15



Mini choco fill

art.	Ø mm.	h.	pcs/pz
47862-10	32	37	20



Tray/Vassoio

art.	dim. cm.	pcs/pz
47862C10	38x10x2,5	20



Chocolate/Ciocolato Decoration

art.	dim. mm.	gr.	pcs/pz
47862-70	64x26	2/3	16



Chocolate/Ciocolato Decoration

art.	dim. mm.	gr.	pcs/pz
47862-71	47x39	2/3	15



Chocolate/Ciocolato Decoration

art.	dim. mm.	gr.	pcs/pz
47862-72	110x7	3/4	22



Chocolate/Ciocolato Decoration

art.	dim. mm.	gr.	pcs/pz
47862-73	66x21	2/3	18



Chocolate/Ciocolato Decoration

art.	dim. mm.	gr.	pcs/pz
47862-74	65x22	2/3	18



Chocolate/Ciocolato Decoration

art.	dim. mm.	gr.	pcs/pz
47862-75	71x71	2/3	18



Chocolate/Ciocolato Decoration

art.	Ø mm.	gr.	pcs/pz
47862-76	51>73	2/3	18



Chocolate/Ciocolato Decoration

art.	dim. mm.	gr.	pcs/pz
47862-77	68x81	2/3	18



Letters & Numbers

art. h. cm.  
47860-86 3

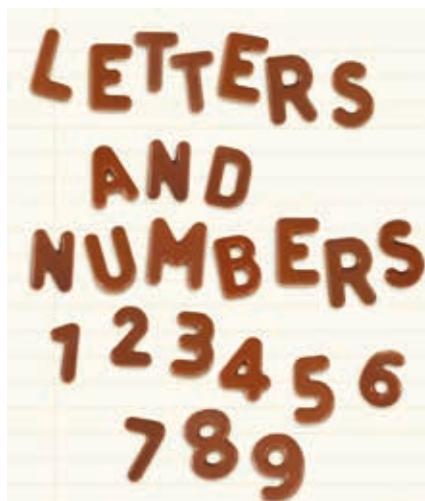

Spheres/Sfere

art. Ø mm. pcs/pz  
47861-16 20 45  
47860-76 30 24



Spheres/Sfere

art. Ø mm. gr. pcs/pz  
47860-77 50 15 8



Spheres/Sfere

art. Ø mm. gr. pcs/pz  
47860-78 100 90 2



PE

Chocolate bars, set 5 pcs

Tavolette cioccolato, set 5 pz  
Schokoladentafel, 5 Stk  
Tablettes chocolat, 5 pièces  
Tabletas chocolate, 5 piezas

art. dim. cm. gr.  
47870-17 15x7x1 100



PE

Chocolate bars, set 5 pcs

Tavolette cioccolato, set 5 pz  
Schokoladentafel, 5-tlg  
Tablettes chocolat, 5 pièces  
Tabletas chocolate, 5 piezas

art. dim. cm. gr.  
47870-18 15x7x1 100



PE

Chocolate bars, set 5 pcs

Tavolette cioccolato, set 5 pz  
Schokoladentafel, 5-tlg  
Tablettes chocolat, 5 pièces  
Tabletas chocolate, 5 piezas

art. dim. cm. gr.  
47870-19 15x7x1 100



PC

Spoon mold

Stampo cucchiaino  
Löffelform  
Moule à cuillère  
Molde cuchara

art. dim. mm.  
47860-90 25x95





**Egg mold kit**

Stampo uovo kit  
Ostereierform-Kit  
Moule à oeuf en kit  
Molde para huevo

art.	Ø mm.	h.	gr.	pcs/pz
47862-87	120	185	280	2

**Thermoformed plastic. – Plastica termoformata.**



**Egg mold kit**

Stampo uovo kit  
Ostereierform-Kit  
Moule à oeuf en kit  
Molde para huevo

art.	Ø mm.	h.	gr.	pcs/pz
47862-88	115	155	230	2

**Thermoformed plastic. – Plastica termoformata.**



**Egg mold kit**

Stampo uovo kit  
Ostereierform-Kit  
Moule à oeuf en kit  
Molde para huevo

art.	Ø mm.	h.	gr.	pcs/pz
47862-89	122	185	270	2

**Thermoformed plastic. – Plastica termoformata.**



**Half egg mold, strong plastic (PETG)**

Stampo 1/2 uovo, plastica rigida  
Ostereierform 1/2  
Moule à 1/2 oeuf  
Molde para 1/2 huevo

art.	dim. cm.	Kg.
47876-11	17x25	0,5-1,0
47876-12	18x28	0,8-1,2
47876-13	34x25	1,5-2,0
47876-14	27x40	2,0-2,5



**PC**

**Half egg mold**

Stampo 1/2 uovo  
Ostereierform 1/2  
Moule à 1/2 oeuf  
Molde para 1/2 huevo

art.	dim. mm.	gr.	pcs/pz
47862-80	44x64	25	10
47862-81	75x105	70	4
47862-82	90x130	150	2
47862-83	104x150	230	2
47862-84	121x175	260	1
47862-85	141x204	380	1
47862-86	157x227	430	1



**PE**

**Egg mold**

Stampo uovo  
Ostereierform  
Moule à oeuf  
Molde para huevos

art.	dim. mm.	pcs/pz
47865-44	220x160x85	1
47865-23	110x80x40	2
47865-80	112x83x44	2
47865-81	125x94x44	2
47865-82	140x100x50	2
47865-83	154x110x55	2



**PE**

**Egg mold**

Stampo uovo  
Ostereierform  
Moule à oeuf  
Molde para huevos

art.	dim. mm.	pcs/pz
47865-66	80x60x25	4
47865-73	40x31x17	14
47865-71	36x23x12	18



**PE**

**Egg mold**

Stampo uovo  
Ostereierform  
Moule à oeuf  
Molde para huevos

art.	dim. mm.	pcs/pz
47865-74	64x44x26	6
47865-72	39x25x13	14



**PE**

**Egg mold**

Stampo uovo  
Ostereierform  
Moule à oeuf  
Molde para huevos

art.	dim. mm.	pcs/pz
47865-77	140x100x49	1
47865-76	95x70x40	2
47865-75	83x54x24	4



3D HOLLOW MOLDS/STAMPI 3D CORPO CAVO  
3D-HOHLFORME/MOULES CREUSES 3D/MOLDE 3D

PC



Easter/Pasqua

art.	h. mm.
47793-11	170



Easter/Pasqua

art.	h. mm.
47793-12	180



Easter/Pasqua

art.	h. mm.
47793-13	140



Easter/Pasqua

art.	h. mm.	#
47793-15	170	2



Easter/Pasqua

art.	h. mm.
47793-16	150



Easter/Pasqua

art.	h. mm.
47793-18	205



Easter/Pasqua

art.	h. mm.
47793-20	160



Easter/Pasqua

art.	h. mm.	#
47793-23	110	3



Easter/Pasqua

art.	h. mm.
47793-26	110



Christmas/Natale

art.	h. mm.	#
47793-32	122	3



Christmas/Natale

art.	h. mm.
47793-33	180



Christmas/Natale

art.	h. mm.
47793-40	168



Christmas/Natale

art.	h. mm.	#
47793-43	114	3



Christmas/Natale

art.	h. mm.
47793-45	135



Ball/Pallone

art.	h. mm.
47793-52	120



Shoe/Scarpa

art.	dim. mm.
47793-55	220x75x170



**FRUITS/TUTTIFRUTTI CM 40X30**

Silicone molds cm 40x30, to create original dessert and surprising monoportions.

Stampi in silicone cm 40x30, per realizzare dessert al piatto e monoportzioni.



**Pear**

**Pera**

art.	Ø mm.	h.	ml.	pcs/pz
47745-06	53	70	90	20

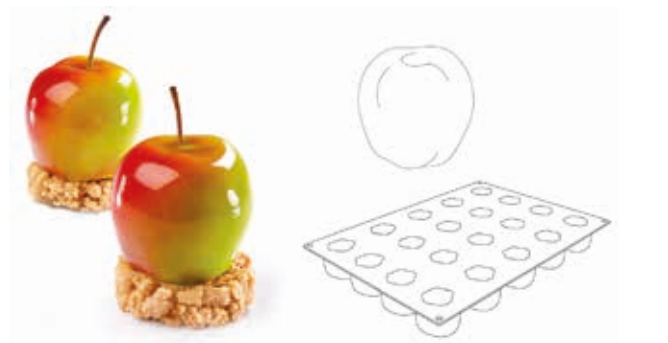

**Apple**

**Mela**

art.	Ø mm.	h.	ml.	pcs/pz
47745-07	55	48	90	20



**Peach/Cherry**

**Pesca/Ciliegia**

art.	dim. mm.	ml.	pcs/pz
47745-08	58x53x46	90	20

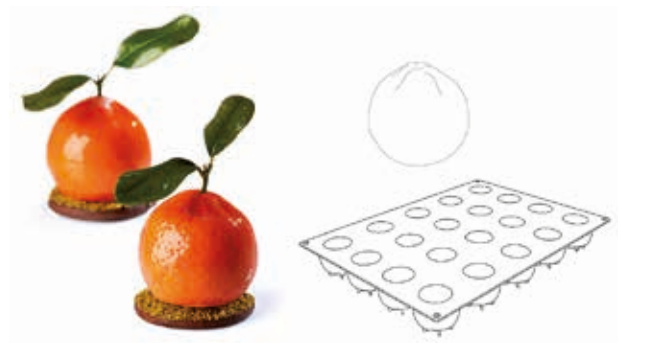

**Tangerine**

**Mandarino**

art.	Ø mm.	h.	ml.	pcs/pz
47745-09	57	50	90	20

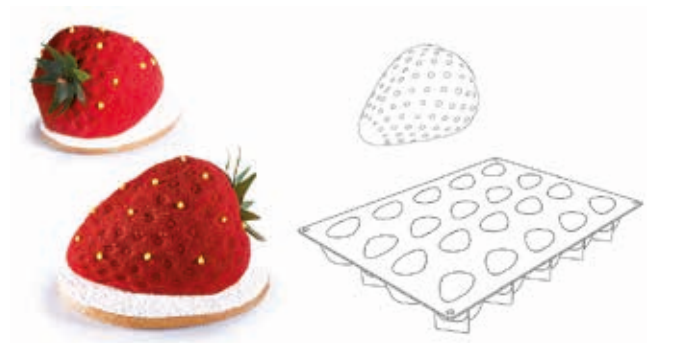

**Strawberry**

**Fragola**

art.	dim. mm.	ml.	pcs/pz
47745-10	71x54x46	90	20

SILICONE MOLDS CM 60X40 - CM 40X30  
STAMPI SILICONE CM 60X40 - CM 40X30



**Quenelle 60x40**

art.	dim. mm.	ml.	pcs/pz
47746-01	66x33x30	32	49



**Mini quenelle 60x40**

art.	dim. mm.	ml.	pcs/pz
47746-02	42x20x20	8	100

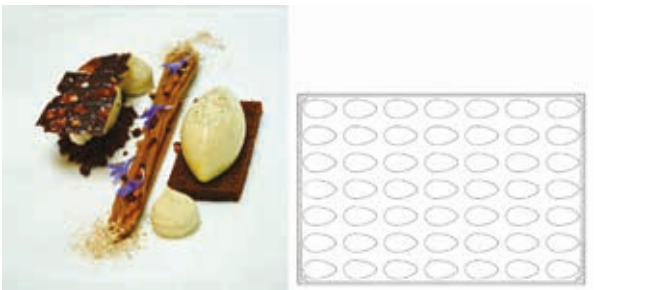

**Quenelle 60x40**

art.	dim. mm.	ml.	pcs/pz
47746-03	66x35x26	34	49



**Mini quenelle 60x40**

art.	dim. mm.	ml.	pcs/pz
47746-04	42x22x17	9	100



**Sphere 40x30**

art.	Ø mm.	ml.	pcs/pz
47745-02	20	4	48



**Sphere 40x30**

art.	Ø mm.	ml.	pcs/pz
47745-03	30	14	30



**Sphere 40x30**

art.	Ø mm.	ml.	pcs/pz
47745-04	40	33	24



**Sphere 40x30**

art.	Ø mm.	ml.	pcs/pz
47745-05	50	65	20





**100% PLATINUM SILICONE CAKE MOLDS, CM 17,5X30 - GN 1/3**  
STAMPI IN SILICONE PLATINICO 100%, CM 17,5X30 - GN 1/3



Suitable for freezing and baking (resistance from **-40°C up to +280°C**). For a correct use, put the moulds on grills or perforated trays, in order to improve the heat diffusion during baking. High non-stick properties to let a perfect demoulding of the product. Can be washed by hand or in dishwasher. Manufactured in conformity with international regulations concerning food contact: D.M. no. 104 of 21/03/1973 (Italian law) - Arrêté du 25/11/1992 (French law) - BGVV (German law) - FDA (USA law).

Adatti per la surgelazione e la cottura (resistono da **-40°C a +280°C**). Per un utilizzo ottimale, posizionare gli stampi su griglie o teglie forate per favorire la diffusione del calore durante la cottura. Elevata antiaderenza per consentire una perfetta sformatura del prodotto. Lavabili a mano e in lavastoviglie. Conforme alle norme internazionali che regolano l'utilizzo di materiali destinati al contatto con sostanze alimentari: D.M. n. 104 del 21/03/1973 (legislazione italiana) - Arrêté du 25/11/1992 (legislazione francese) - BGVV (legislazione tedesca) - FDA (legislazione statunitense).



**Big baba**  
Babà grande

art.	Ø mm.	h.	ml.	pcs/pz
47742-02	55	60	97	8



**Medium baba**  
Babà medio

art.	Ø mm.	h.	ml.	pcs/pz
47742-30	45	48	51	11



**Small baba**  
Babà piccolo

art.	Ø mm.	h.	ml.	pcs/pz
47742-31	35	38	25	15



**Bavarian**  
Bavarese

art.	Ø mm.	h.	ml.	pcs/pz
47742-41	57	57	110	8



**Fluted cake**  
Briolette cannellata

art.	Ø mm.	h.	ml.	pcs/pz
47742-12	79	30	109	6



**Fluted cake**  
Briolette cannellata

art.	Ø mm.	h.	ml.	pcs/pz
47742-27	79	37	100	6



**Cake**  
Cake

art.	dim. mm.	ml.	pcs/pz
47742-56	80x30x30	62	9



**Cannelle**  
Cannelle

art.	Ø mm.	h.	ml.	pcs/pz
47742-51	56	50	70	8



**Cylinder**  
Cilindro

art.	Ø mm.	h.	ml.	pcs/pz
47742-17	60	35	89	8





**Heart**

Cuore

art.	dim. mm.	ml.	pcs/pz
47742-25	65x60x35	97	8



**Biscuit disc**

Disco biscuit

art.	Ø mm.	h.	ml.	pcs/pz
47742-23	103	20	160	3



**Florentine**

Florentine

art.	Ø mm.	h.	ml.	pcs/pz
47742-19	60	12	27	8



**Madeleine**

Madeleine

art.	dim. mm.	ml.	pcs/pz
47742-21	68x45x18	30	9
47742-37	42x30x11,5	8	20



**Mini cannelle**

Mini cannelle

art.	Ø mm.	h.	ml.	pcs/pz
47742-42	35	35	24	18



**Mini financier**

Mini finanziere

art.	dim. mm.	ml.	pcs/pz
47742-14	49x26x11	11	20



**Mini guglhupf**

Mini guglhupf

art.	Ø mm.	h.	ml.	pcs/pz
47742-34	60	33	70	6



**Mini muffin**

Mini muffin

art.	Ø mm.	h.	ml.	pcs/pz
47742-20	50	28	43	11



**Mini oval**

Mini ovale

art.	dim. mm.	ml.	pcs/pz
47742-09	53x33x20	28	16



**Mini pyramid**

Mini piramide

art.	dim. mm.	ml.	pcs/pz
47742-13	36x36x22	13	15



**Mini savarin**

Mini savarin

art.	Ø mm.	h.	ml.	pcs/pz
47742-05	41	12	12	18



**Muffin**

Muffin

art.	Ø mm.	h.	ml.	pcs/pz
47742-08	70	40	130	6



**Muffin**

Muffin

art.	Ø mm.	h.	ml.	pcs/pz
47742-33	80	35	110	5





**Petit four**  
Petit four

art.	Ø mm.	h.	ml.	pcs/pz
47742-24	40	20	22	15



**Pyramid**  
Piramide

art.	dim. mm.	ml.	pcs/pz
47742-07	71x71x40	92	6



**Pomponette**  
Pomponette

art.	Ø mm.	h.	ml.	pcs/pz
47742-06	34	16	13	24



**Savarin**  
Savarin

art.	Ø mm.	h.	ml.	pcs/pz
47742-15	72	23	67	6



**Savarin**  
Savarin

art.	Ø mm.	h.	ml.	pcs/pz
47742-10	65	21	49	8



**Half sphere**  
Semisfera

art.	Ø mm.	h.	ml.	pcs/pz
47742-04	30	17	8,5	24



**Half sphere**  
Semisfera

art.	Ø mm.	h.	ml.	pcs/pz
47742-03	40	20	17	15



**Half sphere**  
Semisfera

art.	Ø mm.	h.	ml.	pcs/pz
47742-48	50	23	33	15



**Half sphere**  
Semisfera

art.	Ø mm.	h.	ml.	pcs/pz
47742-47	60	30	57	8



**Half sphere**  
Semisfera

art.	Ø mm.	h.	ml.	pcs/pz
47742-01	70	35	89	6



**Half sphere**  
Semisfera

art.	Ø mm.	h.	ml.	pcs/pz
47742-29	80	40	134	5



**Tartlet**  
Tartelletta

art.	Ø mm.	h.	ml.	pcs/pz
47742-16	50	15	20	15



**Cakes**  
Tortine

art.	Ø mm.	h.	ml.	pcs/pz
47742-61	80	18	85	6



**Round cake tin**  
Tortiera tonda

art.	Ø mm.	h.	ml.
47765-24	240	42	1850
47765-26	260	45	2250
47765-28	280	45	2600



**Fluted round cake tin**  
Tortiera tonda cannellata

art.	Ø mm.	h.	ml.
47766-26	260	30	1350
47766-28	280	30	1600
47766-30	300	30	1850



**Tart tin**

Crostata

art.	Ø mm.	h.	ml.
47771-28	280	30	1700



**Heart cake tin**

Tortiera cuore

art.	dim. mm.	ml.
47770-21	220x218x35	1150



**Plumcake**

Plumcake

art.	dim. mm.	ml.
47773-24	240x105x65	1385
47773-28	280x105x65	1660



**Rectangulat cake pan**

Tortiera rettangolare

art.	dim. mm.	ml.
47769-28	280x240x40	2670



**Drainer**

Sgocciolatore

art.	dim. cm.
47742-00	30x30x17,5

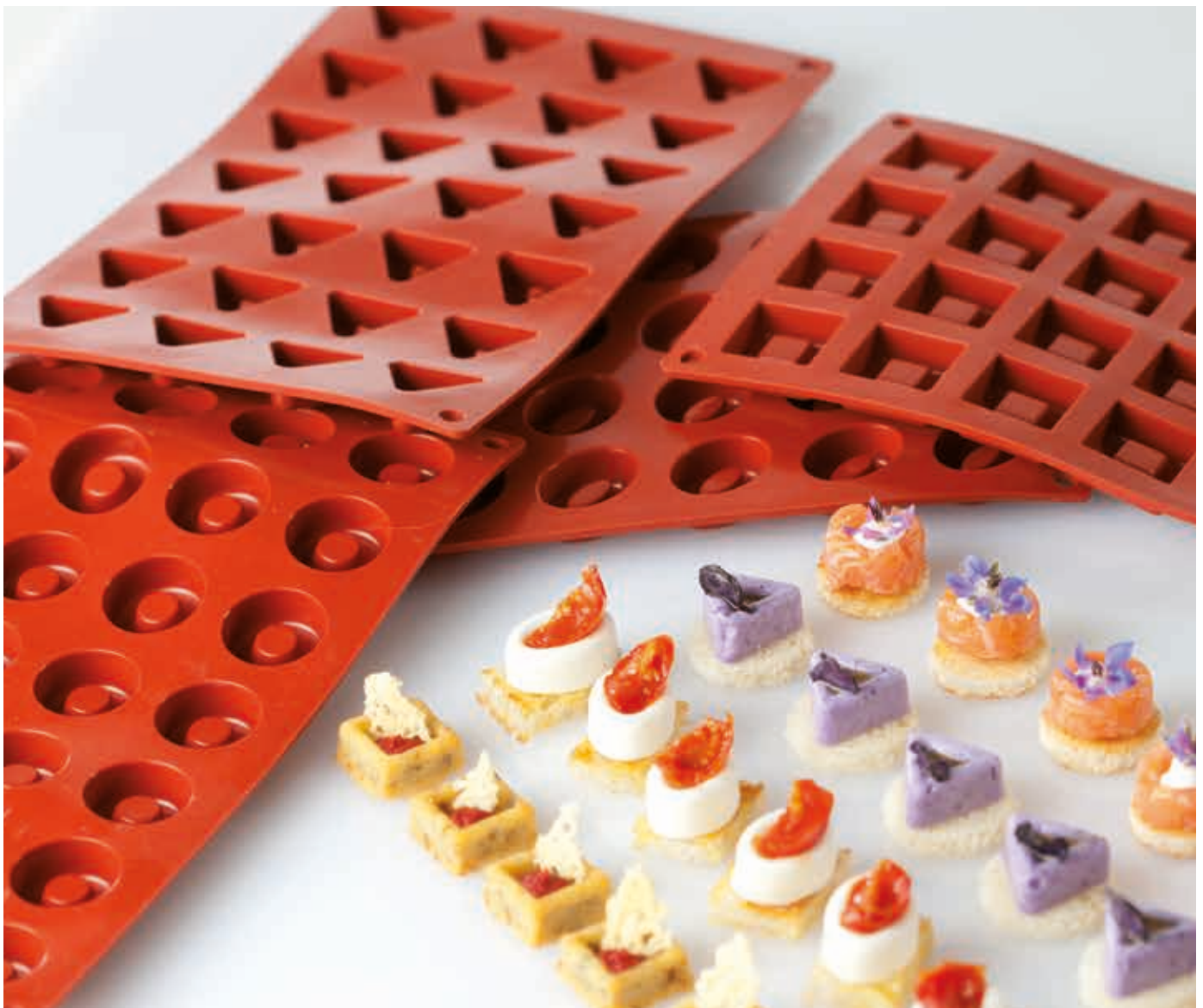
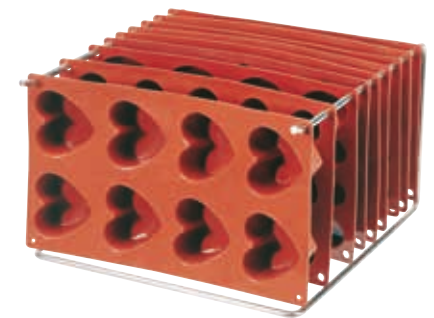



# FLEXIPAN



PASTRY  
PASTICCERIA



The Sasa Demarle Group is the only company in the world to formulate and produce its own food silicone, specially designed for the bakery and pastry industry. The use of this silicone allows an optimal heat distribution, which offers an even baking and colour, as well as perfect non-stick properties for an easy and perfect demoulding. The Flexipan moulds offer great performances with high lifetime expectancy: from 3,000 to 5,000+ baking cycles, depending on the conditions of use. Can be used for cooking and freezing (from -40°C to +240°C), for sweet and/or savory recipes. Can be easily cleaned with water.

Il gruppo Sasa Demarle è l'unica azienda al mondo a formulare e produrre il proprio silicone alimentare, appositamente progettato per l'industria della panificazione e della pasticceria. L'uso di questo silicone consente una distribuzione ottimale del calore, offrendo una cottura e un colore uniformi, nonché proprietà antiaderenti perfette per una facile e perfetta sfornatura. Gli stampi Flexipan offrono grandi prestazioni con un'elevata aspettativa di durata: da 3.000 a 5.000+ cicli di cottura, a seconda delle condizioni di utilizzo. Può essere utilizzato per cucinare e congelare (da -40°C a +240°C), per ricette dolci e/o salate. Si pulisce facilmente con acqua.



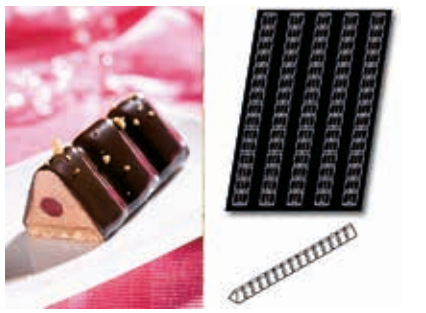

**Annapurna**

Pcs/pz 5 - ml. 370

art. mm.

47740137 495x40x33

With s/s frame. – Con supporto inox.



**Bavarois**

Pcs/pz 18 - ml. 100

art. Ø mm. h.

47740105 78 35



**Caterpillar**

Pcs/pz 5 - ml. 450

art. mm.

47740138 495x40x36

With s/s frame. – Con supporto inox.



**Champagne biscuits**

Pcs/pz 45 - ml. 20

art. mm.

47740-29 109x24x10



**Charlotte**

Pcs/pz 24 - ml. 60

art. Ø mm. h.

47740-80 62 35



**Charlotte**

Pcs/pz 18 - ml. 100

art. Ø mm. h.

47740-23 78 40



**Chocolate bars**

Pcs/pz 18 - ml. 100

art. mm.

47740128 78x58x40

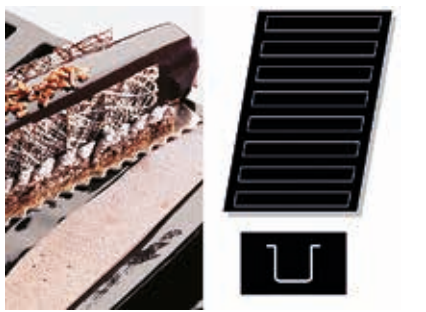

**Christmas log**

Pcs/pz 8 - ml. 450

art. mm.

47740-28 339x40x39

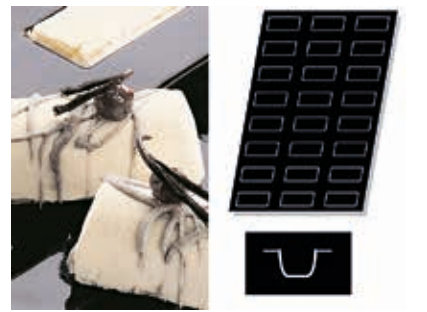

**Christmas log**

Pcs/pz 24 - ml. 80

art. mm.

47740-26 95x40x30



**Christmas log**

Pcs/pz 24 - ml. 115

art. mm.

47740-27 122x42x32



**Christmas log insert**

Pcs/pz 5 - ml. 700

art. mm.

47740-93 495x40x39

With s/s frame. – Con supporto inox.



**Christmas tree**

Pcs/pz 20 - ml. 100

art. mm.

47740119 90x85x30



**Cylinders**

Pcs/pz 24 - ml. 65

art.	Ø mm.	h.
47740-52	63/55	25
47740-06	63/55	35



**Cylinders**

Pcs/pz 15 - ml. 220

art.	Ø mm.	h.
47740-69	82	50
47740-70	91	35



**Cone insert**

Pcs/pz 40 - ml. 24

art.	Ø mm.	h.
47740102	50	40

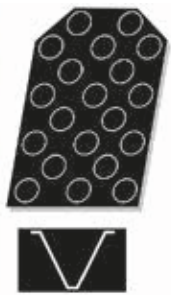

**Cones**

Pcs/pz 20 - ml. 80

art.	Ø mm.	h.
47740103	70	60



**Cookies**

Pcs/pz 40 - ml. 30

art.	Ø mm.	h.
47740-18	59/48	13
47740-60	78	10

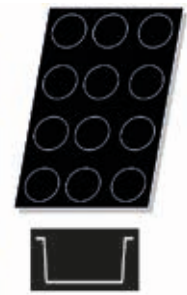

**Cookies**

Pcs/pz 12 - ml. 245

art.	Ø mm.	h.
47740-74	100	35
47740-75	105	40



**Eggs**

Pcs/pz 25 - ml. 95

art.	mm.
47740135	94x60x31



**Exagon**

Pcs/pz 60 - ml. 12

art.	mm.
47740-83	45x40x12



**Financiers**

Pcs/pz 24 - ml. 45

art.	mm.
47740-10	86x46x14



**Flan bases**

Pcs/pz 24 - ml. 70

art.	Ø mm.	h.
47740-43	80	20



**Fluted brioches**

Pcs/pz 24 - ml. 60

art.	mm.
47740-57	62x49x26



**Fluted brioches**

Pcs/pz 24 - ml. 60

art.	Ø mm.	h.
47740-58	68	25
47740-59	78	30
47740-16	81	37





**Fluted cakes**

Pcs/pz 16 - ml. 105

art. mm.

47740-95 110x60x25



**Fluted ingots**

Pcs/pz 24 - ml. 90

art. mm.

47740127 106x46x25



**Fluted tartlets**

Pcs/pz 24 - ml. 70

art. mm.

47740132 78x78x20



**Half cylinder**

Pcs/pz 48 - ml. 20

art. mm.

47740125 85x17x15



**Half sphere**

Pcs/pz 48 - ml. 20

art. Ø mm. h.

47740-02 42 21



**Half sphere**

Pcs/pz 24 - ml. 125

art. Ø mm. h.

47740-38 80 40



**Half sphere**

Pcs/pz 28 - ml. 105

art. Ø mm. h.

47740-37 58 31



**Half sphere**

Pcs/pz 24 - ml. 105

art. Ø mm. h.

47740-03 70 40



**Hearts**

Pcs/pz 81 - ml. 20

art. mm.

47740-89 75x65x35



**Hearts**

Pcs/pz 20 - ml. 90

art. mm.

47740-41 66x62x35



**Hexagons**

Pcs/pz 20 - ml. 90

art. Ø mm. h.

47740130 80 25



**Hollow ingot**

Pcs/pz 24 - ml. 70

art. mm.

47740123 100x40x25

47740124 120x40x25





**Ingot**

Pcs/pz 24 - ml. 100

art. mm.

47740122 120x40x25



**Ingot**

Pcs/pz 18 - ml. 139

art. mm.

47740-94 102x58x30



**Interlacing hearts**

Pcs/pz 8 - ml. 200

art. mm.

47740101 120x113x35



**Landscapes**

Pcs/pz 27 - ml. 80

art. Ø mm. h.

47740144 75 24



**Little cushion**

Pcs/pz 24 - ml. 70

art. mm.

47740-77 71x57x23



**Madeleines**

Pcs/pz 40 - ml. 35

art. mm.

47740-17 78x47x19



**Medallions**

Pcs/pz 54 - ml. 14

art. Ø mm. h.

47740-50 38 10



**Medallions**

Pcs/pz 96 - ml. 5

art. Ø mm. h.

47740-97 28 8



**Mini Charlotte**

Pcs/pz 60 - ml. 9

art. Ø mm. h.

47740-82 35 15



**Mini chenilles**

Pcs/pz 27 - ml. 90

art. mm.

47740143 102x40x36



**Mini drops**

Pcs/pz 56 - ml. 18

art. mm.

47740133 52x32x20



**Mini écrins**

Pcs/pz 24 - ml. 65

art. mm.

47740142 50x50x29



**PASTRY PASTICCERIA  
FLEXIPAN SILICONE 60X40 CM**



**Mini Madeleines**

Pcs/pz 56 - ml. 15

art. mm.

47740106 52x33x15



**Mini St Honoré crown**

Pcs/pz 18 - ml. 70

art. Ø mm. h.

47740131 80 20



**Muffins**

Pcs/pz 24 - ml. 125

art. Ø mm. h.

47740-19 73 40

47740-68 79 36



**Optagon**

Pcs/pz 40 - ml. 28

art. mm.

47740-34 43x40x26



**Oval savarins**

Pcs/pz 12 - ml. 230

art. mm.

47740-81 100x80x45



**Oval savarins**

Pcs/pz 30 - ml. 48

art. mm.

47740111 70x50x22



**Oval savarins**

Pcs/pz 24 - ml. 70

art. mm.

47740-44 80x60x25

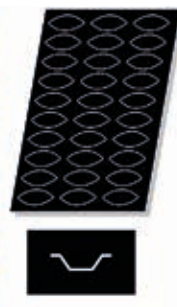

**Oval tartlets**

Pcs/pz 30 - ml. 35

art. mm.

47740-32 106x45x15



**Ovals**

Pcs/pz 24 - ml. 80

art. mm.

47740-49 96x45x28



**Ovals**

Pcs/pz 30 - ml. 55

art. mm.

47740-46 70x50x25

47740-47 70x50x30



**Ovals**

Pcs/pz 20 - ml. 100

art. mm.

47740-48 85x60x30

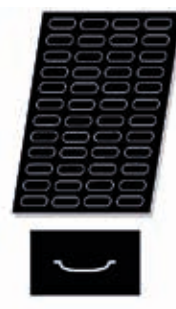

**Ovals**

Pcs/pz 48 - ml. 15

art. mm.

47740-92 70x30x10





**Ovals**

Pcs/pz 24 - ml. 80

art. mm.

47740-55 130x48x18



**Pomponnettes**

Pcs/pz 96 - ml. 14

art. Ø mm. h.

47740-04 36 17



**Puddings**

Pcs/pz 15 - ml. 128

art. Ø mm. h.

47740104 65 55



**Pyramids**

Pcs/pz 24 - ml. 90

art. mm.

47740-13 71x71x41



**Pyramids flat bottom**

Pcs/pz 35 - ml. 50

art. mm.

47740-39 50x50x35



**Quiches**

Pcs/pz 15 - ml. 135

art. Ø mm. h.

47740-85 96 25



**Quiches**

Pcs/pz 24 - ml. 65

art. Ø mm. h.

47740-30 77 20



**Quiches**

Pcs/pz 42 - ml. 30

art. mm.

47740-45 60x40x25



**Quiches**

Pcs/pz 15 - ml. 140

art. Ø mm. h.

47740-62 102 20



**Quiches**

Pcs/pz 6 - ml. 200

art. Ø mm. h.

47740-64 147 12

47740-65 150 15

47740-66 166 12



**Quiches**

Pcs/pz 6 - ml. 360

art. Ø mm. h.

47740-71 140 25

47740-72 150 24

47740-05 186 12



**Rectangular cakes**

Pcs/pz 24 - ml. 55

art. mm.

47740-25 80x30x30





**Rectangular cakes**

Pcs/pz 25 - ml. 110

art. mm.

47740-24 89x46x25

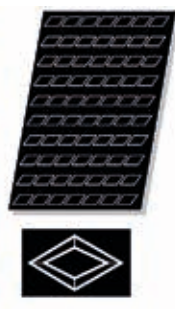

**Rhombus**

Pcs/pz 70 - ml. 9

art. mm.

47740-36 60x35x10



**Round**

Pcs/pz 11 - ml. 75

art. Ø mm. h.

47740-63 125 16



**Round brioche**

Pcs/pz 24 - ml. 65

art. Ø mm. h.

47740-56 79 15



**Savarin zaphire**

Pcs/pz 24 - ml. 80

art. mm.

47740114 70x70x32



**Savarins**

Pcs/pz 35 - ml. 50

art. Ø mm. h.

47740-20 66 20



**Savarins**

Pcs/pz 24 - ml. 65

art. Ø mm. h.

47740-15 70 23



**Scoop out**

Pcs/pz 24 - ml. 90

art. mm.

47740145 85x61x30



**Shells**

Pcs/pz 24 - ml. 70

art. mm.

47740-79 80x75x20

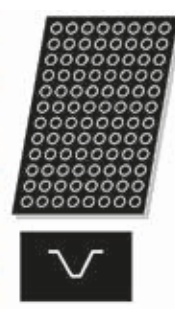

**Small cones**

Pcs/pz 96 - ml. 6

art. Ø mm. h.

47740-99 30 20



**Small cylinders**

Pcs/pz 48 - ml. 25

art. Ø mm. h.

47740-51 40 20

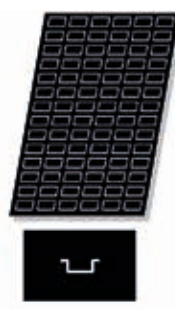

**Small financiers**

Pcs/pz 84 - ml. 10

art. mm.

47740-09 50x26x11





**Small fluted tartlet**

Pcs/pz 40 - ml. 11

art. mm.

47740100 46x38x15



**Small half sphere**

Pcs/pz 96 - ml. 6

art. Ø mm. h.

47740-87 26 16

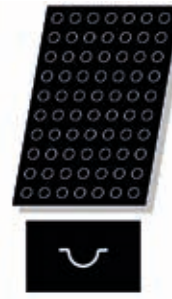

**Small half sphere**

Pcs/pz 70 - ml. 10

art. Ø mm. h.

47740-01 29 18



**Small hearts**

Pcs/pz 70 - ml. 15

art. mm.

47740115 41x38x16



**Small muffins**

Pcs/pz 40 - ml. 45

art. Ø mm. h.

47740-67 51 29



**Small oval savarins**

Pcs/pz 60 - ml. 9

art. mm.

47740-98 40x30x12



**Small oval tartlets**

Pcs/pz 48 - ml. 10

art. mm.

47740-31 66x27x11



**Small ovals**

Pcs/pz 50 - ml. 20

art. mm.

47740-11 51x31x20



**Small ovals flat bottom**

Pcs/pz 64 - ml. 18

art. mm.

47740-91 57x35x12

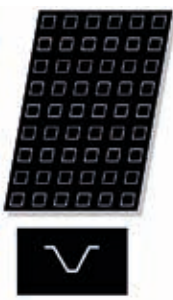

**Small pyramids**

Pcs/pz 54 - ml. 15

art. mm.

47740-12 35x35x23

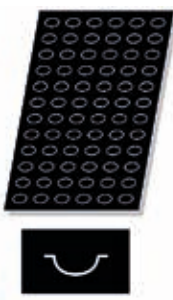

**Small quenelles**

Pcs/pz 72 - ml. 56

art. mm.

47740-90 42x26x20



**Small quiches**

Pcs/pz 54 - ml. 22

art. Ø mm. h.

47740-33 40 20





**Small quiches**

Pcs/pz 60 - ml. 13

art.	Ø mm.	h.
47740-07	42	10

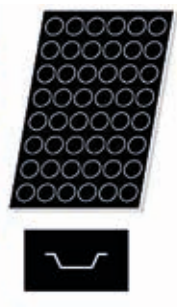

**Small quiches**

Pcs/pz 48 - ml. 20

art.	Ø mm.	h.
47740-08	48	15



**Small quiches**

Pcs/pz 40 - ml. 35

art.	Ø mm.	h.
47740-84	58	20

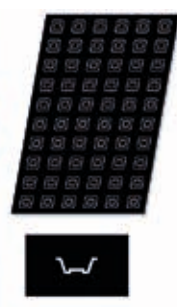

**Small Savarins**

Pcs/pz 60 - ml. 15

art.	mm.
47740107	7x37x17



**Small savarins**

Pcs/pz 60 - ml. 10

art.	Ø mm.	h.
47740-14	41	12



**Small squares**

Pcs/pz 60 - ml. 18

art.	mm.
47740116	37x37x17



**Small squares**

Pcs/pz 60 - ml. 20

art.	mm.
47740109	45x45x12



**Small upside-down half sphere**

Pcs/pz 45 - ml. 6

art.	Ø mm.	h.
47740-86	26	16



**Square Savarins**

Pcs/pz 35 - ml. 45

art.	mm.
47740108	56x56x24



**Square Savarins**

Pcs/pz 24 - ml. 100

art.	mm.
47740-96	70x70x30



**Squares**

Pcs/pz 35 - ml. 60

art.	mm.
47740117	56x56x24

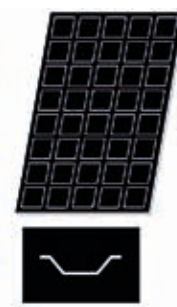

**Squares**

Pcs/pz 40 - ml. 40

art.	mm.
47740110	60x60x15



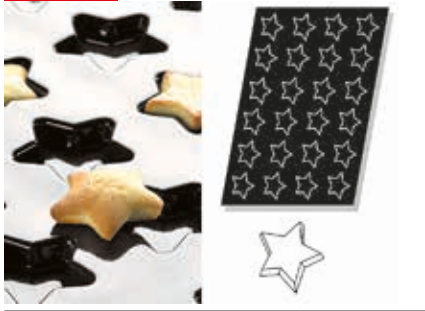

**Stars**

Pcs/pz 24 - ml. 35

art. mm.

47740-88 80x65x15

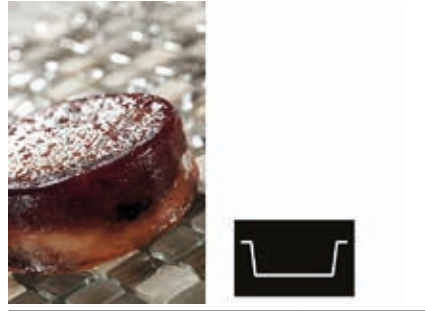

**Tarte tatin**

Pcs/pz 15 - ml. 135

art. Ø mm. h.

47740-73 82 30



**Teddy bear**

Pcs/pz 18 - ml. 80

art. mm.

47740-53 90x55x20



**Triangles**

Pcs/pz 80 - ml. 7

art. mm.

47740-35 48x41x10



**Variou petits-fours**

Pcs/pz 60

art. h. mm.

47740134 22



**Zaphire**

Pcs/pz 54 - ml. 17

art. mm.

47740112 40x40x24



**Zaphire**

Pcs/pz 24 - ml. 75

art. mm.

47740113 70x70x35



**Calisson**

Pcs/pz 20 - ml. 118

art. mm.

47743-03 180x90x50



**Lemon**

Pcs/pz 20 - ml. 73

art. mm.

47743-05 85x65x34



**Triangles**

Pcs/pz 24 - ml. 80

art. mm.

47743-10 70x95x25



**Donuts**

Pcs/pz 8

art. Ø mm. h.

47743-13 88 30







**Insert ring**

Pcs/pz 24

art.	Ø mm.	h.
47743-15	61	9



**Ring 3D**

Pcs/pz 24

art.	Ø mm.	h.
47743-16	76	25



**Pearls**

Pcs/pz 15 - ml. 100

art.	Ø mm.	h.
47743-65	73	40

FLEXIPAN GN 1/1



**Small half sphere**

Pcs/pz 5 - ml. 63

art.	Ø mm.	h.
47741-76	23	11

FLEXIPAN CM 40X30



**Small hearts**

Pcs/pz 30 - ml. 15

art.	mm.
47741-78	52x49x10

FLEXIPAN CM 40X30



**Half sphere flat**

Pcs/pz 48 - ml. 10

art.	Ø mm.	h.
47741-77	30	13

FLEXIPAN CM 40X30



**Twist**

Pcs/pz 48

art.	Ø mm.	h.
47741-00	32	20

FLEXIPAN CM 40X30



**Stars**

Pcs/pz 48

art.	Ø mm.	h.
47741-01	32	13

FLEXIPAN CM 40X30



**Insert fingers**

Pcs/pz 18

art.	mm.
47741-02	120x11

FLEXIPAN CM 40X30



**Sphere 3D**

Pcs/pz 8

art.	Ø mm.	h.
47741-05	65	50

FLEXIPAN CM 40X30



**Cylinder**

Pcs/pz 24 - ml. 148

art.	Ø mm.	h.
47744-30	70	40

FLEXIPAT CM 60x40



**Cube**

Pcs/pz 96 - ml. 17

art.	mm.
47744-32	30x30x20

FLEXIPAT CM 60x40



**Kougloff**

Pcs/pz 24 - ml. 150

art.	Ø mm.	h.
47744-31	80	54

**FLEXIPAT CM 60x40**



**Diamond**

Pcs/pz 24 - ml. 100

art.	Ø mm.	h.
47744-34	79	40

**FLEXIPAT CM 60x40**



**Waffels**

Pcs/pz 8 - ml. 100

art.	mm.
47741-38	80x127x15

**FLEXIPAT CM 40X30**



**Fingers**

Pcs/pz 24 - ml. 54

art.	mm.
47741-37	129x28x15

**FLEXIPAT CM 40X30**



**Buche**

ml. 140

art.	mm.
47744-80	280x85x70

**FLEXIPAT CM 40X30**



**Half sphere**

ml. 1600

art.	Ø mm.	h.
47744-81	180	90

**FLEXIPAT CM 40X30**



**Flexiform desserts**

ml. 222

art.	mm.
47744-58	253x253x45

**FLEXIPAT CM 40X30**



**Flexiform desserts**

ml. 980

art.	mm.
47744-59	600x400x50

**FLEXIPAT CM 40X30**



**Flexiform desserts**

art.	mm.
47744-48	480x280x13
47744-60	555x360x10
47744-62	555x360x20



**Tapis Rosette**

art.	Ø mm.
47744-10	240



**Tapis Venetian cane**

art.	mm.
47744-19	555x360





**Tapis Labyrinth**

art. mm.  
47744-21 600x400



**Tapis Bubbles**

art. mm.  
47744-36 600x400

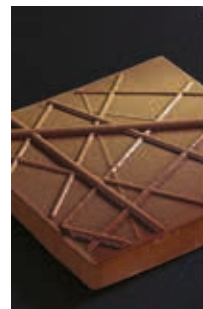

**Tapis Mikado**

art. mm.  
47744-37 600x400



**Tapis Snowflake**

art. Ø mm.  
47744-63 240



**Tapis Buche2**

art. mm.  
47744-70 275x185



**Tapis Buche1**

art. mm.  
47744-71 275x185

**FLEXIPAN AIR CM 60X40**

PUFFS - BIGNE' - WINDBEUTEL - CHOUX - BOLLOS/BREADS - PANE - BROT - PAIN - PAN



Flexible pans made of silicone and glass fiber fabric and bi-component, designed for bread-making and bakery products, especially for cream puffs dough. The pre-formed shapes make easy obtaining perfect, regular and same size products. Neither greasing the sheet nor spiking the dough is required before baking. The non-stick property of the material allows an easy and perfect extraction. They have a well-ventilated texture that ensures proper heat circulation, to obtain a crusty finished product with excellent color. Non-stick FLEXIPAN® AIR sheets are very durable, lasting up to 1500 cycles without any risk of sticking. For baking up to +240°, as well as for freezing at -40°, and are also designed to hold frozen dough.

Stampi flessibili realizzati in silicone e tessuto in fibra di vetro e bicomponente, ideali per la panificazione e prodotti dolci da forno, in particolare per la pasta di bigné. Grazie alle impronte preformate, preparare prodotti uguali e regolari diventa facile. Non è più indispensabile spennellare con tuorlo o forare la pasta. Grazie alle sue proprietà antiaderenti l'estrazione è impeccabile. Hanno una texture ben ventilata che garantisce una corretta circolazione del calore, per ottenere un prodotto finito croccante e dal colore eccellente. Gli stampi FLEXIPAN® AIR sono molto resistenti, durano fino a 1500 cicli senza alcun rischio che il prodotto si attacchi. Per cotture fino a +240°, come pure per congelare a -40°, e sono progettati anche per contenere impasti congelati.



**Paris-Brest**

Pcs/pz 24 - ml. 10

art. Ø mm. h.  
41760-27 80 15



**Oval choux**

Pcs/pz 25 - ml. 56

art. mm.  
41760-26 90x60x15



**Baby choux**

Pcs/pz 59 - ml. 4

art. Ø mm. h.  
41760-22 30 5



**Big choux**

Pcs/pz 28 - ml. 48

art.	Ø mm.	h.
41759-01	67	15



**Eclairs - Right handed. Per ambidestri**

Pcs/pz 18 - ml. 15

art.	mm.
41760-20	125x25x5



**Eclairs - Left handed. Per mancini.**

Pcs/pz 18 - ml. 15

art.	mm.
41760-21	125x25x5



**Round shapes/Rotondi**

Pcs/pz 28 - ml. 48

art.	Ø mm.	h.
41759-01	67	15



**Round shapes/Rotondi**

Pcs/pz 15 - ml. 140

art.	Ø mm.	h.
41759-05	102	20



**Round shapes/Rotondi**

Pcs/pz 11 - ml. 175

art.	Ø mm.	h.
41759-09	125	16



**Oval shapes/Ovali**

Pcs/pz 24 - ml. 80

art.	mm.	h.
41760-02	95x40	30



**Oval shapes/Ovali**

Pcs/pz 18 - ml. 50

art.	mm.	h.
41760-05	155x41	25



**Oval shapes/Ovali**

Pcs/pz 12 - ml. 230

art.	mm.	h.
41760-06	169x64	30







**Oval shapes/Ovali**

Pcs/pz 8 - ml. 400

art.	mm.	h.
41760-08	259x64	30



**Oval shapes/Ovali**

Pcs/pz 6 - ml. 445

art.	mm.	h.
41760-09	299x60	30



**French loaves perforated sheet, silicone coated**

Teglia alluminio forato, siliconata

Pariserbrotblech, Silikon-beschichtet

Plaque perforée pain parisien, siliconée

Placa pan perforada, siliconada

art.	cm.	pcs/pz
41758-53	53x32	4
41758-60	60x40	5
41758-65	65x43	6
41758-85	85x43	6



ABS

**Bread mould**

Stampo per pane

Brot-Ausstechforme

Découpoir à pain

Cortador para pan

art.	cm.
47041-01	14x10



ABS

**Bread mould**

Stampo per pane

Brot-Ausstechforme

Découpoir à pain

Cortador para pan

art.	cm.
47041-02	14x11



ABS

**Bread mould**

Stampo per pane

Brot-Ausstechforme

Découpoir à pain

Cortador para pan

art.	Ø cm.
47041-03	12,5



ABS

**Bread mould**

Stampo per pane

Brot-Ausstechforme

Découpoir à pain

Cortador para pan

art.	cm.
47041-04	16,5x8,5



ABS

**Bread mould**

Stampo per pane

Brot-Ausstechforme

Découpoir à pain

Cortador para pan

art.	Ø cm.
47041-05	12,5



ABS

**Bread mould**

Stampo per pane

Brot-Ausstechforme

Découpoir à pain

Cortador para pan

art.	Ø cm.
47041-06	8



ABS

**Bread mould**

Stampo per pane

Brot-Ausstechforme

Découpoir à pain

Cortador para pan

art.	Ø cm.
47041-07	8



ABS

**Bread mould**

Stampo per pane

Brot-Ausstechforme

Découpoir à pain

Cortador para pan

art.	Ø cm.
47041-08	8



ABS

**Bread mould**

Stampo per pane

Brot-Ausstechforme

Découpoir à pain

Cortador para pan

art.	Ø cm.
47041-15	8



**ABS**

**Kaiser bread marker**

Marcatore pane Kaiser  
Kaiserbrot Stempel  
Empreinte pain Kaiser  
Molde pan Kaiser

art.	Ø cm.	l. cm.
47040-00	6	20



**Bread brush**

Spazzola pane  
Brot-Bürste  
Brosse à pain  
Cepillo para pan

art.	l. cm.
42614-04	24,5
42614-05	32,0
42614-06	41,0
42614-07	46,0



**SS**

**Disposable baker's blades**

Lame panettiere usa e getta  
Einweg-Bäcker-Klingen  
Incisette boulanger jetables  
Láminas del panadero desechables

art.	l. cm.	pcs/pz
48290-10	12	10



**PE**

**Bread basket**

Cesta pane  
Brot-Korb  
Corbeille à pain  
Cesta pan

art.	cm.	lt.
44982-04	57x36x34	40
44982-06	66x45x35	60
44982-10	78x52x40	100



**PP**

**Bread proofing basket**

Cestino impasto  
Gärkorb  
Banneton  
Molde para pan

art.	Ø cm.	h.	gr.	col.
47042-19	19	7,5	500	●
47042-22	22	9,3	1000	●
47042-25	25	9,0	1500	●



**PP**

**Bread proofing basket**

Cestino impasto  
Gärkorb  
Banneton  
Molde para pan

art.	cm.	gr.	col.
47043-27	27x12x6,5	500	●
47043-35	35x13x7,2	1000	●
47043-42	42x14x7,5	1500	●





# ETHNIC CUISINE CUCINA ETNICA

ASIA FUSION



The images of the products in this chapter reflect the characteristics of the products in the warehouse. However, they have to be considered mainly for illustrative purposes only. Although we make every effort to display the products accurately, the products received may vary slightly from those images. In any case the changes are intended as improvements and do not alter the function, nor lessen the utility of the product.

Tutte le foto degli articoli presenti nel capitolo rispecchiano il più possibile le caratteristiche dei prodotti presenti in magazzino. Teniamo comunque a precisare che le immagini sono indicative ed i prodotti reali potrebbero differire nei colori e nelle dimensioni. Le variazioni sono in ogni caso migliorative e tali da non alterare la natura e la funzionalità del prodotto stesso.



**FINE MELAMINE SERIES THARA**



Withstands temperatures from -20°C to +70°C.

Termoresistenti da -20°C a +70°C.



**Rice bowl**  
Coppa riso  
Reistasse  
Bol à riz  
Copa arroz

art.	Ø cm.	h.	lt.	col.
44463-11	11	7	0,3	●



**Tray**  
Vassoio  
Platte  
Plateau  
Placa

art.	dim. cm.	col.
44464-23	23,5x7,5x2	●



**Tray**  
Vassoio  
Platte  
Plateau  
Placa

art.	dim. cm.	col.
44465-24	24,5x6,5x1,5	●



**Bowl**  
Ciotola  
Schüssel  
Bol  
Bol Ensalada

art.	Ø cm.	h.	col.
44452-31	31	8,5	○
44452B31	31	8,5	●



**Bowl**  
Ciotola  
Schüssel  
Bol  
Bol Ensalada

art.	dim. cm.	col.
44453-14	14,5x12x5,5	○
44453B14	14,5x12x5,5	●



**Bowl**  
Ciotola  
Schüssel  
Bol  
Bol Ensalada

art.	Ø cm.	h.	col.
44454-11	11,5	4	○
44454B11	11,5	4	●



**Bowl**  
Ciotola  
Schüssel  
Bol  
Bol Ensalada

art.	dim. cm.	col.
44455-09	9x7x2,5	○
44455B09	9x7x2,5	●



**Bowl**  
Ciotola  
Schüssel  
Bol  
Bol Ensalada

art.	dim. cm.	col.
44456-14	14x9x2,5	○
44456B14	14x9x2,5	●



**Bowl**  
Ciotola  
Schüssel  
Bol  
Bol Ensalada

art.	dim. cm.	col.
44457-32	32,5x14x4	○
44457B32	32,5x14x4	●





**Tray**

Vassoio  
Platte  
Plateau  
Placa

art.	dim. cm.	col.
44461-20	20x20x4,5	○
44461B20	20x20x4,5	●



**Bowl**

Ciotola  
Schüssel  
Bol

Bol Ensalada

art.	dim. cm.	col.
44450-21	21x21x11	○
44450B21	21x21x11	●



**Bowl**

Ciotola  
Schüssel  
Bol

Bol Ensalada

art.	dim. cm.	col.
44450-12	12x12x4	○
44450B12	12x12x4	●



**Bowl**

Ciotola  
Schüssel  
Bol

Bol Ensalada

art.	dim. cm.	col.
44450-17	17,5x17,5x7	○
44450B17	17,5x17,5x7	●



**Tray**

Vassoio  
Platte  
Plateau  
Placa

art.	dim. cm.	col.
44451-22	22x12x3	○
44451B22	22x12x3	●



**Tray**

Vassoio  
Platte  
Plateau  
Placa

art.	dim. cm.	col.
44462-25	25x25x5,5	○
44462B25	25x25x5,5	●



**Dish**

Piatto  
Teller  
Assiette  
Plato

art.	Ø cm.	h.	col.
44459-28	28	3	○
44459B28	28	3	●



**Bowl**

Ciotola  
Schüssel  
Bol

Bol Ensalada

art.	dim. cm.	h.	col.
44450-11	11x10	3	○
44450B11	11x10	3	●



**Bowl**

Ciotola  
Schüssel  
Bol

Bol Ensalada

art.	dim. cm.	h.	col.
44450-13	13x11	3,5	○
44450B13	13x11	3,5	●



**Bowl**

Ciotola  
Schüssel  
Bol

Bol Ensalada

art.	dim. cm.	col.
44450-15	17,5x15,5x5,5	○
44450B15	17,5x15,5x5,5	●



**Tray**

Vassoio  
Platte  
Plateau  
Placa

art.	dim. cm.	col.
44450-23	22x23,5x5,5	○
44450B23	22x23,5x5,5	●





MF

**Soup/risce bowl with lid**  
Ciotola riso con coperchio  
Reisschüssel mit Deckel  
Bol à riz avec couvercle  
Bol arroz con tapa

art.	Ø cm.	h.
49655-34	10	10



MF

**Towel tray**  
Vassoio portatovagliolo  
Handtuch-Tablett  
Plateau à serviette  
Bandeja servilleta

art.	dim. cm.
49655-46	17x7

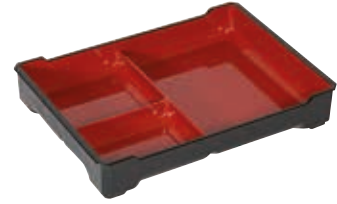

MF

**Bento tray**  
Vassoio bento  
Bento-Platte  
Plateau à bento  
Bandeja bento

art.	dim. cm.
49655-36	22x16x3,5



MF

**Bento box with lid**  
Scatola bento con coperchio  
Bento-Box mit Deckel  
Boîte à bento avec couvercle  
Caja bento con tapa

art.	dim. cm.
49655-44	30x24



MF

**Bento box with lid**  
Scatola bento con coperchio  
Bento-Box mit Deckel  
Boîte à bento avec couvercle  
Caja bento con tapa

art.	dim. cm.
49655-37	24x24x5,5



NEW

MF

**Bento box with lid 7 pcs**  
Scatola bento con coperchio 7 pz  
Bento-Box mit Deckel 7-tlg  
Boîte à bento avec couvercle 7 pcs  
Caja bento con tapa 7 pz

art.	dim. cm.
44357-07	30x25x8



MF

**Sushi serving dish**  
Piatto a servire  
Sushi-Servierteller  
Plat à sushi  
Plato para sushi

art.	Ø cm.	h.
49655-21	22	5,5
49655-22	25	6
49655-23	28	6



MF

**Sushi-sashimi bridge**  
Ponte per sushi e sashimi  
Sushi-Brücke  
Sushi et sashimi pont  
Puente para sushi-sashimi

art.	dim. cm.
49655-41	28x13,5x6



B

**Sushi geta board**  
Tagliere sushi  
Sushibrett  
Planche à sushi  
Tabla para sushi

art.	dim. cm.
49655-24	24x15x3



MF

**Hand roll stand, laquered**  
Supporto per temaki, laccato  
Temaki-Ständer  
Support pour temaki  
Soporte para temaki

art.	dim. cm.
49655-32	18x9,5x8



W

**Hand roll stand**  
Supporto per temaki  
Temaki-Ständer  
Support pour temaki  
Soporte para temaki

art.	dim. cm.
49655-31	18x9x8,5





MF

**Sushi-sashimi boat**

Barca per sushi e sashimi  
Sushi-Sashimi-Boot  
Bateau sushi et sashimi  
Barco sushi-sashimi

art. dim. cm.  
49655-45 28x13,5x6



B

**Sushi-sashimi boat**

Barca per sushi e sashimi  
Sushi-Sashimi-Boot  
Bateau sushi et sashimi  
Barco sushi-sashimi

art. dim. cm.  
49655-29 34x12x10,5



MF

**Soup spoon**

Cucchiaio brodo  
Suppenlöffel  
Cuiller à soupe  
Cuchara sopa

art. dim. cm. col.  
44850-13 13,5x4,5 ○  
44850B13 13,5x4,5 ●



MF

**Soup spoon**

Cucchiaio brodo  
Suppenlöffel  
Cuiller à soupe  
Cuchara sopa

art. l. cm.  
49655-35 14,5



PR

**Sauce pourer**

Salsiera  
Sauciere  
Saucière  
Salsera

art.	dim. cm.	lt.	U. Pack
67305-57	7x11	0,2	6
67308-57	5x4	0,03	6



PR

**Flat plate**

Piattino piano  
Teller flach  
Petite assiette plate  
Platillo llano

art.	dim. cm.	U. Pack
67303Q80	9x9	6
67303Q81	12x12	6



PR

**Deep plate**

Piattino fondo  
Teller tief  
Petite assiette creuse  
Platillo hondo

art.	dim. cm.	U. Pack
67303Q82	9x9	6
67303Q83	12x12	6



PR

**Small dish**

Ciotolina  
Schale  
Petite assiette  
Platillo

art.	dim. cm.	U. Pack
67303M01	9x7x3	6



PR

**Small dish**

Piattino  
Schale  
Petite assiette  
Platillo

art.	Ø cm.	h.	U. Pack
67303M04	10,5	2	6



PR

**Small dish**

Piattino  
Schale  
Petite assiette  
Platillo

art.	dim. cm.	U. Pack
67303M02	14x7x2	6



PR

**Small dish**

Ciotolina  
Schale  
Petite assiette  
Platillo

art.	Ø cm.	h.	U. Pack
67303M03	10	2	6



PR

**Small dish**

Ciotolina  
Schale  
Petite assiette  
Platillo

art.	dim. cm.	U. Pack
67303M05	11x8	6
67303M06	16x11	6



PR

**Chinese spoon**  
Cucchiaio cinesee  
Löffel  
Cuillère chinoise  
Cucharita

art.	l. cm.	U. Pack
67303M07	13	12



PR

**Sake jug**  
Caraffa sake  
Sakekrug  
Carafe à sake  
Jarra sake

art.	Ø cm.	h.	ml.	col.
49655-25	5,2	13,5	120	○
49655-42	5,7	18,0	250	○



PR

**Sake jug**  
Caraffa sake  
Sakekrug  
Carafe à sake  
Jarra sake

art.	Ø cm.	h.	ml.	col.
49655-57	5,2	13,5	130	●
49655-58	5,7	18,0	230	●



PR

**Sake cup**  
Coppetta sake  
Sakebecher  
Coupe à sake  
Copa sake

art.	Ø cm.	h.	ml.
49655-26	4,5	4,5	40



PR

**Sake cup**  
Coppetta sake  
Sakebecher  
Coupe à sake  
Copa sake

art.	Ø cm.	h.	ml.	col.
49655-43	4,5	5,5	40	○
49655-60	4,5	5,5	40	●



PR

**Sake cup**  
Coppetta sake  
Sakebecher  
Coupe à sake  
Copa sake

art.	Ø cm.	h.
49655-56	5	4



PR

**Sake jug**  
Caraffa sake  
Sakekrug  
Carafe à sake  
Jarra sake

art.	Ø cm.	h.
49655-55	6	9,5



PR

**Sake warmer**  
Riscalda sake  
Sakewärmer  
Réchaud à sake  
Calentador de sake

art.	Ø cm.	h.
49655-54	9,5	9



PR

**Soy pot**  
Vaso soia  
Sojakrug  
Carafe soja sauce  
Jarra soja

art.	Ø cm.	h.
49655-52	12	7,5



PR

**Soy pot**  
Vaso soia  
Sojakrug  
Carafe soja sauce  
Jarra soja

art.	Ø cm.	h.
49655-51	6,5	7



PR

**Soy pot**  
Vaso soia  
Sojakrug  
Carafe soja sauce  
Jarra soja

art.	Ø cm.	h.	ml.
49655-53	5,5	8,5	130



NEW



**Teapot**  
Teiera  
Teekanne  
Théière  
Tetera

art.	dim. cm.	h.	lt.
49655-70	19,5x18	15	0,8

**Cast iron with s/steel strainer. For 2-3 cups.**  
In ghisa con colino inox. Per 2-3 tazze.



NEW



**Teapot warmer**

Rechaud  
Stövchen  
Chauffe-théière  
Calentador

art.	Ø cm.	h. mm.
49655-72	13	7,5



NEW



**Teapot**

Teiera  
Teekanne  
Théière  
Tetera

art.	dim. cm.	h.	lt.
49655-80	12,5x11	12,5	0,3

**Cast iron, without tea strainer.**  
In ghisa, senza colino.



NEW



**Coaster**

Sottoteiera  
Untersetzer  
Repose théière  
Reposa tetera

art.	Ø cm.	h. mm.
49655-81	13,5	1,5

**Cast iron with non-slip feet.**  
In ghisa con piedini antiscivolo.



NEW

B



**Tray**

Vassoio  
Tablett  
Plateau  
Bandeja

art.	GN	dim. cm.
49655-86	1/2	32,5x26,5x3
49655-87	1/3	32,5x17,6x3
49655-88	2/4	53x16,2x3



PR

**Chopstick rest**

Supporto bacchette cinesi  
Ess-Stäbchen Ablage  
Pose baguettes  
Soporte para palillos

art.	dim. cm.	col.
49655-27	4,5x3	●
49655-28	4,5x3	○



PR

**Chopstick rest**

Supporto bacchette cinesi  
Ess-Stäbchen Ablage  
Pose baguettes  
Soporte para palillos

art.	dim. cm.
49655-61	6x1,5



MF

**Chopsticks**

Bacchette cinesi  
Ess-Stäbchen  
Baguettes  
Palillos

art.	l. cm.	pairs/paia
49658-01	27	10



**MF**

**Chopsticks**

Bacchette cinesi  
Ess-Stäbchen  
Baguettes  
Palillos

art.	l. cm.	pairs/paia
49658-02	27	10



**B**

**Disposable chopsticks**

Bacchette monouso  
Einweg Ess-Stäbchen  
Baguettes jetables  
Palillos desechables

art.	l. cm.	pairs/paia
48300-29	21	50



**B**

**Disposable chopsticks**

Bacchette monouso  
Einweg Ess-Stäbchen  
Baguettes jetables  
Palillos desechables

art.	l. cm.	pairs/paia
49627-22	24	100



**Japanese chopsticks**

Bacchette giapponesi  
Japanische-Ess-Stäbchen  
Baguettes japonaises  
Palillos japoneses

art.	l. cm.	pairs/paia
49628-00	24	1

**Assorted colors. – Colori assortiti.**



**SS**

**Japanese chopsticks**

Bacchette giapponesi  
Japanische-Ess-Stäbchen  
Baguettes japonaises  
Palillos japoneses

art.	l. cm.	pairs/paia
49655-30	23	5



**B**

**Noshikushi skewers**

Spiedini noshikushi  
Noshikushi Spieße  
Brochettes noshikushi  
Pinchos noshikushi

art.	l. cm.	pcs/pz
48300-42	10,5	100



**B**

**Tepokushi skewers**

Spiedini tepokushi  
Tepokushi Spieße  
Brochettes tepokushi  
Pinchos tepokushi

art.	l. cm.	pcs/pz
48300-43	9	100
48300-33	15	100



**W**

**Mooncake mould flower**

Stampo mooncake flower  
Mondkuchenform Flower  
Moule à mooncake flower  
Molde mooncake flower

art.	49664-01
------	----------



**W**

**Mooncake mould fish**

Stampo mooncake fish  
Mondkuchenform Fish  
Moule à mooncake fish  
Molde mooncake fish

art.	49664-02
------	----------



**W**

**Mooncake mould long life**

Stampo mooncake long life  
Mondkuchenform Long Life  
Moule à mooncake long life  
Molde mooncake long life

art.	49664-03
------	----------



**W**

**Mooncake mould long life acacia**

Stampo mooncake long life acacia  
Mondkuchenform Long Life Acacia  
Moule à mooncake long life acacia  
Molde mooncake long life acacia

art.	49664-04
------	----------



**W**

**Mooncake mould double flower**

Stampo mooncake double flower  
Mondkuchenform Double Flower  
Moule à mooncake double flower  
Molde mooncake double flower

art.	49664-05
------	----------





B

**Sushi mat**

Stuoietta  
Sushi-Matte  
Natte à rouler les sushis  
Mantelín para sushi

art.	dim. cm.
49626-00	24x24



B

**Sushi mat**

Stuoietta  
Sushi-Matte  
Natte à rouler les sushis  
Mantelín para sushi

art.	dim. cm.
49626-02	27x27



**Sushi-maki set 3 pcs**

Kit 3 pz per sushi-maki  
Sushi-Maki-Satz 3 Stk  
Kit 3 pcs pour réaliser les sushi-maki  
Juego 3 pz para sushi-maki

art.	dim. cm.
49655-02	26x7,5x6



**Maki roll mould**

Stampo per maki  
Maki-Ausstechform  
Moule à maki  
Molde para maki

art.	dim. cm.
49655-10	20,5x4x4



**Nigiri mould**

Stampo per nigiri  
Nigiri-Ausstechform  
Moule à nigiri  
Molde para nigiri

art.	dim. cm.
49655-16	16x6x2,5



MF

**Rice spoon**

Cucchiaio riso  
Reislöffel  
Cuiller à riz  
Cuchara arroz

art.	dim. cm.
49655-03	22x7



B

**Steamer**

Cuocivapore  
Dampfgarer  
Panier vapeur  
Vaporera

art.	Ø cm.
49603-15	16
49603-20	20
49603-25	25
49603-30	30
49603-40	40
49603-50	50

2 bodies + 1 cover. – 2 ceste + 1 coperchio.



B

**Steamer**

Cuocivapore  
Dampfgarer  
Panier vapeur  
Vaporera

art.	dim. cm.
49656-15	15,2x15,2
49656-16	16,5x16,5
49656-20	20,3x20,3



**W**

**Hangiri/sushi rice tub**

Vasca riso hangiri  
Hangiri/Sushi-Reis-Wanne  
Cuve è riz sushi/hangiri  
Barril arroz sushi/hangiri

art.	Ø cm.
49655-49	45
49655-50	60



**Serving basket sticky rice**

Contentitore per riso dolce  
Klebreis-Servierkorb  
Panier de service à riz gluant  
Cesta para servir arroz pegado

art.	Ø cm.
49660-09	9,5
49660-13	13,0

**Bamboo.**



**Sticky rice lao pot**

Pentola per riso dolce  
Klebreis Laotopf  
Marmite à riz gluant  
Olla para arroz pegado

art.	Ø cm.
49661-22	22
49661-24	24

**Aluminum. – Alluminio.**



**Sticky rice lao basket**

Cesto per riso dolce  
Klebreis-Laokorb  
Panier cuisson à riz gluant  
Cesta de cocción arroz pegado

art.	Ø cm.
49662-40	40
49662-50	50

**Bamboo.**



**Sticky rice cooking set**

Set cottura riso dolce  
Klebreis Kochset  
Ensemble de cuisson riz gluant  
Set de cocina arroz pegado

art.	Ø cm.
49663-22	22
49663-24	24

**Aluminum and bamboo. – Alluminio e bamboo.**



**Wok with grid and cover, 3-ply**

Wok c/griglia e coperchio, 3-ply  
Wok mit Rost und Deckel, 3-ply  
Wok avec grille et couvercle, 3-ply  
Wok con rejilla y tapa, 3-ply

art.	Ø cm.	h.
12529-32	32	8



**Steel wok pan**

Wok, ferro  
Wok-Eisenpfanne  
Poêle chinoise, acier  
Wok, hierro

art.	Ø cm.	h.
11713-32	32	10
11713-40	40	11



**Steel wok pan**

Wok, ferro  
Wok-Eisenpfanne  
Poêle chinoise, acier  
Wok, hierro

art.	Ø cm.	h.
49604-31	30,5	9
49604-36	35,5	11
49604-41	40,5	12



**Non stick wok**

Wok antiaderente  
Wok-Pfanne, nichtaftend  
Poêle chinoise, anti-adhérente  
Wok, antiaderente

art.	Ø cm.
49612-30	30,5
49612-33	33,0



**Wok stand, chromed**

Base per wok, cromata  
Fuss für Wokpfanne, verchromt  
Base pour wok, chromée  
Base para Wok, cromada

art.	Ø cm.	h.
49600-00	20-25	5,5



SS

**Rice steamer shelf**

Supporto per cottura a vapore  
Reis-Dampfer-Fuss  
Étagère à vapeur  
Estante de cocción al vapor

art.	Ø cm.	h.
49653-10	10,0	7,5
49653-12	12,5	7,5
49653-15	15,0	7,5
49653-17	18,0	7,5
49653-20	20,0	7,5



SS

**Rice steamer shelf**

Supporto per cottura a vapore  
Reis-Dampfer-Fuss  
Étagère à vapeur  
Estante de cocción al vapor

art.	Ø cm.	h.
49652-10	10,0	2,5
49652-12	12,5	2,5
49652-15	15,0	2,5
49652-17	18,0	2,5
49652-20	20,0	2,5



**Tempura rack, chromed**

Griglia per tempura, cromata  
Tempura-Rost, verchromt  
Grille à tempura, chromée  
Rejilla para tempura, cromada

art.	Ø cm.
49613-30	30,5
49613-33	33,0
49613-35	35,5

Flat bottom. – Fondo piano.



SS

**Steam rack**

Griglia per cottura a vapore  
Dämpf-Rost  
Grille à vapeur  
Rejilla

art.	Ø cm.
49654-15	15,2
49654-20	20,3
49654-25	25,4



SS

**Dim Sum steam rack**

Griglia Dim Sum  
Dim Sum Dämpf-Rost  
Grille Dim Sum  
Rejilla Dim Sum

art.	Ø cm.
49659-24	24,0
49659-26	26,0



**Steel wok pan**

Wok, ferro  
Wok-Eisenpfanne  
Poêle chinoise, acier  
Wok, hierro

art.	Ø cm.	h.
49605-46	45,5	14,0
49605-61	61,0	18,5
49605-71	71,0	22,0



**Wok lid, aluminum**

Coperchio per wok, alluminio  
Wok-Deckel, Aluminium  
Couvercle pour poêle chinoise, alu  
Tapa para wok, aluminio

art.	Ø cm.	h.
49602-25	24,5	4,5
49602-30	29,5	6,2
49602-33	32,0	9,0
49602-35	34,5	10,3



SS

**Wok stand**

Base per wok  
Fuss für Wokpfanne  
Base pour wok  
Base para Wok

art.	Ø cm.
11953-22	22



**Agemono pot and stand**

Casseruola con supporto  
Kasserolle mit Untersetzer  
Casserole avec support  
Cacerola con soporte

art.	Ø cm.
49655-64	20



SS

SS

**Toban skillet**

Padella Toban  
Toban-Pfanne  
Poêle Toban  
Sartén Toban

art.	Ø cm.
49655-40	19



**Balti pan**

Padella balti/karahi

Balti-Pfanne

Poêle balti

Sartén balti

art. Ø cm.

49657-15 15,2

49657-20 20,3

49657-25 25,4

**Carbon steel.** – Acciaio al carbonio.



**Balti pan with wood base**

Padella balti base legno

Balti-Pfanne mit Holz-Basis

Poêle balti avec base en bois

Sartén balti base de madera

art. Ø cm.

49656-02 15,2

**Carbon steel.** – Acciaio al carbonio.



**Steel fry pan**

Padella per friggere, ferro

Frittier-Eisenpfanne

Tuille à frire, acier

Sartén freidora, hierro

art. Ø cm. h. lt.

41707-32 32 9,8 6,0

41707-36 36 11,0 8,8

41707-40 40 13,4 12,2

41707-45 45 15,0 17,3

41707-50 50 17,6 23,5



**Wire basket, tinned**

Cestello per friggere, stagnato

Frittier-Rost, verzinkt

Grille à frire, étamée

Cesta escurrefrito, estañada

art. Ø cm. h.

41708-32 32 11,0

41708-36 36 11,5

41708-40 40 12,4

41708-45 45 15,5

41708-50 50 16,5



**Japanese omelettes pan, non-stick**

Padella omelette, antiaderente

Japanische Omelette Pfanne mit

Antihaftbeschichtung

Poêle à omelettes, revêtement anti-adhésif

Sartén antiadherente para tortillas japonesas

art. dim. cm.

49655-38 22x24x3,5



**Tamagoyaki pan**

Padella Tamagoyaki

Tamagoyaki-Pfanne

Poêle à Tamagoyaki

Sartén Tamagoyaki

art. dim. cm.

49655-66 18x15x3



**Steel tawa pan**

Padella tawa, ferro

Tawa-Eisenpfanne

Poêle tawa, acier

Sartén tawa, hierro

art. Ø cm.

49614-28 28

**Used in Indian cooking, for chapattis and anything that needs quick cooking at high temperatures.** – Utilizzate nella cucina indiana, per focacce e tutto ciò che ha bisogno di cottura rapida ad alta temperatura.



**Chinese hot pot, aluminium**

Pentola cinese, alluminio

Chinese- Suppentopf, alu

Marmite chinoise, alu

Olla chino, aluminio

art. Ø cm. h.

49616-22 22 17

49616-24 24 20

49616-26 26 22





SS

**Steamer**

Cuocivapore  
Dampf-Kocher  
Cuisieur à vapeur  
Cuscusera

art.	Ø cm.	h.
49606-51	51	14
49606-00	51	14
49606-01	51	20



-01

-00

-51



**Scoop**

Porzionatore  
Portionierer  
Cuiller  
Racionador

art.
49616S01
49616B01



**Clay pot**

Casseruola terracotta  
Tontopf  
Pot d'argile  
Olla de barro

art.	Ø cm.	h.	Kg.
49632-24	23	10	1,5
49632-32	32	16	2,7



**Clay pot**

Casseruola terracotta  
Tontopf  
Pot d'argile  
Olla de barro

art.	Ø cm.	h.	Kg.
49633-22	22	10	0,75
49633-24	24	12	1,35



**Cast iron sizzler platter with wood**

Piatto ghisa con vassoio legno  
Gusseisenplatte mit Holzbrett  
Plat en fonte avec planche bois  
Fuente hierro fundido con tabla madera

art.	dim. cm.
49615-01	33,5x22



**Mortar and pestle**

Mortaio e pestello  
Mörser und Stößel  
Mortier et pilon  
Mortero y pistilo

art.	Ø cm.	h.	Kg.
49618-12	12,5	9,0	1,9
49618-15	15,0	10,0	3,2
49618-18	17,0	11,5	3,9



SS

**Wasabi grater**

Grattugia per wasabi  
Wasabi-Raffel  
Rape à wasabi  
Rallador para wasabi

art.	dim. cm.
42555-11	11x7,5

**Dishwasher safe. To mash garlic, wasabi, ginger, horseradish. To grind almonds, nutmeg.**

Lavabile in lavastoviglie. Per grattugiare aglio, wasabi, zenzero, rafano, mandorle, noce moscata.



SS

**Oil pourer**

Oliera  
Ölkanne  
Huilière  
Alcuza

art.	ml.
41780-05	500
41780-07	750
41780-09	1000



**Wonton noodle skimmer**

Schiumarola Wonton  
Wonton-Sieb  
Ecumoire à Wonton  
Colador para Wonton

art.	Ø cm.	h.
49601-14	14	13

**Stainless steel and natural wood.**  
Inox e legno naturale.



**Chinese kitchen scissors**

Forbici cucina cinesi  
Chinesische Küchenschere  
Ciseaux de cuisine chinois  
Tijeras de cocina china

art.	dim. cm.
49636-00	17x8,5

**Stainless steel and brass. – Inox e ottone.**



**Duck fur pincer**

Pinza per anatra  
Ente Fell Zange  
Pince à canard  
Pinza pato

art.	l. cm.
49637-00	15



**Fish scaler**

Squamapesce  
Fischentschupper  
Ecailleur à poisson  
Escamador

art.	l. cm.
49638-00	22



**Fry basket, coarse mesh**

Schiumarola fritto, rete grossa  
Frittierkorb  
Panier de friture  
Cesta para freír

art.	Ø cm.
49607-15	15,0
49607-20	20,0
49607-25	25,5
49607-30	30,5

**Bamboo handle, stainless steel mesh.**  
Manico bamboo, rete inox.



**Fry basket, fine mesh**

Schiumarola fritto, rete fine  
Frittierkorb  
Panier de friture  
Cesta para freír

art.	Ø cm.
49608-15	15,0
49608-20	20,0
49608-25	25,5
49608-30	30,5
49608-35	35,5

**Bamboo handle, stainless steel mesh.**  
Manico bamboo, rete inox.



**SS**

**Skimmer**

Schiumarola  
Schaumlöffel  
Ecumoire  
Espumadera

art.	Ø cm.	l. cm.
49617-23	24	45
49617-25	26	46
49617-30	30	50

**Stainless steel and natural wood.**  
Inox e legno naturale.



**Ladle**

Mestolo  
Schöpföffel  
Louche  
Cacillo

art.	Ø cm.
49609-12	11,8
49609-14	13,8

**Stainless steel and natural wood.**  
Inox e legno naturale.



**Spatula**

Paletta  
Teigschäber  
Spatule  
Espátula

art.	dim. cm.
49610-11	11x10,2
49610-14	13,3x12

**Stainless steel and natural wood.**  
Inox e legno naturale.



**B**

**Cooking chopsticks**

Bastoncini per cucinare  
Kochstäbchen  
Baguettes de cuisine  
Palillos para cocinar

art.	l. cm.
49629-45	45

**Disposable. – Monouso.**



**Wok brush**

Pennello per wok  
Wok-Pinsel  
Pinceaux à wok  
Pincel para wok

art.	l. cm.
49634-00	25,5



**Wooden handled wok brush**

Spazzola per wook  
Wok-Bürste, Holzgriff  
Brosse à wok, manche bois  
Cepillo para wok, mango madera

art.	l. cm.
49635-00	27,5



# PIZZA

ETHNIC CUISINE  
CUCINA ETNICA





SS

**Oil pourer**

Oliera  
Ölkanne  
Huilière  
Alcuza

art.	lt.
41780-05	0,50
41780-07	0,75
41780-09	1,00



**Oil pourer, copper**

Oliera, rame  
Ölkanne, Kupfer  
Huilière, cuivre  
Alcuza, cobre

art.	h. cm.	lt.
41781-05	23,0	0,50
41781-10	27,0	1,00
41781-15	31,5	1,50

**Tinned inside. – Interno stagnato.**



**Pizza peel, aluminum**

Pala pizza, alluminio  
Pizzaschaufel, Aluminum  
Pelle à pizza, aluminium  
Pala pizza, aluminio

art.	Ø cm.	l. cm.	gr.
11701-02	32	150	736
11701-06	37	150	870
11701-10	41	150	1226
11701-13	45	150	1460
11701-16	50	150	1604



**Pizza peel, aluminum**

Pala pizza, alluminio  
Pizzaschaufel, Aluminum  
Pelle à pizza, aluminium  
Pala pizza, aluminio

art.	cm.	l. cm.	gr.
11702-02	32x32	150	784
11702-06	37x37	150	894
11702-10	41x41	150	1246
11702-16	50x50	150	1694



**Perforated pizza peel, aluminum**

Pala pizza forata, alluminio  
Pizzaschaufel, gelocht, Aluminum  
Pelle à pizza perforée, aluminium  
Pala pizza perforada, aluminio

art.	cm.	l. cm.	gr.
11704-02	32x32	150	700
11704-06	37x37	150	816
11704-13	45x45	150	1250
11704-16	50x50	150	1409



SS

**Pizza peel, small**

Palettino  
Pizzaschaufel, klein  
Petite pelle à pizza  
Pala pizza, pequeña

art.	Ø cm.	l. cm.	gr.
11705-02	17	150	780
11705-06	20	150	846
11705-10	23	150	938
11705-14	26	150	984



SS

**Perforated pizza peel, small**

Palettino forato  
Pizzaschaufel, gelocht, klein  
Petite pelle à pizza perforée  
Pala pizza perforada, pequeña

art.	Ø cm.	l. cm.	gr.
11706-02	17	150	770
11706-06	20	150	830
11706-10	23	150	912
11706-14	26	150	954



**Oven pizza peel, aluminum**

Pala per infornare, alluminio  
Back-Pizzaschaufel, Aluminum  
Pelle à enfourner, aluminium  
Pala para hornear, aluminio

art.	cm.	l. cm.	gr.
41765-32	32x32	150	1200
41765-37	37x37	150	1400
41765-41	41x41	150	1500
41765-45	45x45	150	1600
41765-50	50x50	150	1700



SS

**Oven pizza peel**

Pala per infornare  
Back-Pizzaschaufel  
Pelle à enfourner  
Pala para hornear

art.	Ø cm.	l. cm.	gr.
41735-29	29	150	870

**Aluminum handle. – Manico alluminio.**





**Oven pizza peel, aluminum**  
Pala per infornare, alluminio  
Back-Pizzaschaufel, Aluminum  
Pelle à enfourner, aluminum  
Pala para hornear, aluminio

art.	cm.	l. cm.	gr.
41736-32	32x30	150	954



SS

**Perforated pizza peel, small**  
Palettino forato  
Pizzaschaufel, gelocht, klein  
Petite pelle à pizza perforée  
Pala pizza perforada, pequeña

art.	Ø cm.	l. cm.	gr.
41737-17	17	150	890
41737-20	20	150	910
41737-23	23	150	960



SS

**Pizza peel, small**  
Palettino  
Pizzaschaufel, klein  
Petite pelle à pizza  
Pala pizza, pequeña

art.	Ø cm.	l. cm.	gr.
41738-17	17	150	905
41738-20	20	150	975
41738-23	23	150	1030



**Pizza peel, small, aluminum**  
Palettino, alluminio  
Pizzaschaufel, klein, Aluminum  
Petite pelle à pizza, aluminum  
Pala pizza, pequeña, aluminio

art.	Ø cm.	l. cm.	gr.
41735-20	20	150	800



W

**Pizza peel**  
Pala pizza  
Pizzaschaufel  
Pelle à enfourner  
Pala pizza

art.	Ø cm.	l. cm.
41764-28	28	125
41764-33	33	200
41764-40	40	200



SS

**Ash shovel**  
Paleta cenere  
Asche-Schaufel  
Pelle à cendres  
Paleta recogedar cenizas

art.	cm.	l. cm.
41768-21	21x31	173



SS

**Rake**  
Rastrello  
Harke  
Râteau  
Rastrillo

art.	cm.	l. cm.
41768-22	24x10	150



**Adjustable brush**  
Spazzola orientabile  
Drehbare Bürste  
Brosse orientable  
Cepillo orientable

art.	cm.	l. cm.
41767-20	20x6,5	155

Brass bristles. – Setole ottone.



**Adjustable brush**  
Spazzola orientabile  
Drehbare Bürste  
Brosse orientable  
Cepillo orientable

art.	cm.	l. cm.
41766-27	27x7	150

Brass bristles. – Setole ottone.



**Adjustable brush**  
Spazzola orientabile  
Drehbare Bürste  
Brosse orientable  
Cepillo orientable

art.	cm.	l. cm.
41766-16	16x5	150

Brass bristles. – Setole ottone.



**Adjustable brush**  
Spazzola orientabile  
Drehbare Bürste  
Brosse orientable  
Cepillo orientable

art.	cm.	l. cm.
41766-14	14x7	150



**Adjustable brush**  
Spazzola orientabile  
Drehbare Bürste  
Brosse orientable  
Cepillo orientable

art.	cm.	l. cm.
41739-20	20x6,6	150



**Brush for grill cleaning**

Spazzola per griglia, setole in acciaio  
Grillenbürste mit Stahlborsten  
Brosser pour grille avec soies en acier  
Cepillo para parrilla con cerdas de acero

art. cm.  
41740-00 27x4x15



**Support for peels**

Poggia pala pizza  
Schaufelträger  
Support pour pelles à pizza  
Portapala para palas

art. cm. Kg.  
41769-36 41x16x39 3,0  
41769-50 53x16x39 3,5

SS



**Small pizza peel wall rack, aluminum**

Portapaleto da muro, alluminio  
Pizzaschaufel-Wandgestell, Aluminium  
Support mural petite pelle, aluminum  
Soporte mural de pala pizza, aluminio

art.  
41769-02



**Pizza peel wall rack, aluminum**

Appendi pala da muro, alluminio  
Pizzaschaufel-Wandgestell, Aluminium  
Support mural pour pelle, aluminum  
Soporte mural de pala pizza, aluminio

art.  
41769-01



**Double-sided brush**

Spazzola bi-facciale  
Bürste Deidseitig  
Brosse double face  
Cepillo doble

art. l. cm.  
41761-02 100



**Pizza peel rack**

Porta pale  
Ständer für Schaufeln  
Support pour pelles  
Soporte para pala

art. h. cm. Kg.  
41769-00 172 14

SS



**Pizza peel, marble base**

Porta pale, base marmo  
Ständer für Schaufeln  
Support pour pelles  
Soporte para pala

art. cm.  
41769G00 25x35x180



SS



**Adjustable brush**

Spazzola orientabile  
Drehbare Bürste  
Brosse orientable  
Cepillo orientable

art. cm. l. cm.  
41767G20 20x6 160



**Pizza peel, aluminum**

Pala pizza, alluminio  
Pizzaschaufel, Aluminium  
Pelle à pizza, aluminum  
Pala pizza, aluminio

art. cm. l. cm.  
41704G33 33x33 150  
41704G36 36x36 150



**Supplied WITHOUT peels. – Fornito SENZA pale.**

**Brass bristles. – Setole ottone.**



**Perforated pizza peel, small**

Palettino forato  
Pizzaschaufel, gelocht, klein  
Petite pelle à pizza perforée  
Pala pizza perforada, pequeña

art.	Ø cm.	l. cm.
41737G20	20	150
41737G23	23	150



**Pan gripper**

Pinza per teglie  
Pizzablech-Zange  
Pince à plaques  
Pinza fuente horns

art.	l. cm.
42822-00	23



**Pan gripper**

Pinza per teglie  
Pizzablech-Zange  
Pince à plaques  
Pinza fuente horns

art.	l. cm.
18323-00	23



**Pizza cutter**

Tronchetto tagliapizza  
Pizzaschneider  
Coupe-pizza  
Cortador de pizza

art.	Ø cm.	l. cm.
18324-00	13,5	19



**Divisible pizza scissors**

Forbice pizza smontabile  
Pizzaschere, teilbar  
Ciseaux à pizza, divisible  
Tijeras para pizza desmontables

art.	l. cm.
18276-00	25



**Pizza wheel**

Rotella taglia pizza  
Pizzaschneider  
Roulette à pizza  
Ruleta cortapizzas

art.	Ø cm.
18324-10	10



**Pizza knife**

Coltello per pizzaiolo  
Pizzamesser  
Couteau à pizza  
Cuchillo para pizza

art.	l. cm.
48280-45	23



**Perforated spatula**

Paletta triangolare, forata  
Palette, gelocht  
Palette perforée  
Pala triangular perforada

art.	cm.
18301-01	12x15



**Spatula**

Paletta triangolare  
Palette  
Palette  
Pala triangular

art.	cm.
18301-02	12x15



**Peel with handle, aluminum**

Pala manicata, alluminio  
Schaufel mit Griff, Aluminium  
Pelle avec manche, alu  
Pala con mango, aluminio

art.	Ø cm.
42826-32	32
42826-37	37



**Perforated peel with handle**

Pala manicata, forata  
Schaufel mit Griff, gelocht  
Pelle perforée avec manche  
Pala con mango, perforada

art.	cm.
18302-01	22x18



**Peel with handle**

Pala manicata  
Schaufel mit Griff  
Pelle avec manche  
Pala con mango

art.	cm.
18302-02	22x18





**W**

**Round platter**

Vassoio rotondo  
Buchenholzbrett, rund  
Plateau rond  
Bandeja redonda

art.	Ø cm.	h. cm.
41774-33	33	1,2

**Beech wood.** – Faggio.



**W**

**Cutting board 1 portion**

Tagliere monoporzione  
Einzelportion Tablett  
Planche mono-portion  
Tabla monoporción

art.	cm.
41775-34	34x20x1,2

**Beech wood.** – Faggio.



**MF**

**Round platter**

Vassoio rotondo  
Tablett, rund  
Plateau rond  
Bandeja redonda

art.	Ø cm.	h. mm.
44473-02	33	0,8
44473-03	43	0,8



**Pizza plate with wooden platter**

Piatto pizza con tagliere legno  
Pizzaplatte mit Holzbrett  
Plat pizza avec planche bois  
Fuente pizza con tabla madera

art.	Ø cm.
44232S16	16
44232S20	20

**Enamelled cast iron plate.**  
Piatto in ghisa smaltata.



**Pizza plate with wooden platter**

Piatto pizza con tagliere legno  
Pizzaplatte mit Holzbrett  
Plat pizza avec planche bois  
Fuente pizza con tabla madera

art.	Ø cm.
44233-20	20

**Enamelled cast iron plate. Cups not included.**  
Piatto in ghisa smaltata. Ciotoline non incluse.

**MODULAR SYSTEM BASE=LID EXTENSIBLE HEIGHT**  
**SISTEMA MODULARE BASE=COPERCHIO ALTEZZA ESTENSIBILE**



The modular system where the base and lid are the same element. Rotation system allows the steam of hot pizzas to escape.

Sistema modulare, la base e coperchio sono lo stesso elemento. Dotato di sistema rotabile, per la fuoriuscita del vapore delle pizze calde.



**PPE**

**Base and lid**

Base e coperchio  
Basis und Abdeckung  
Base et couvercle  
Base y tapa

art.	cm. ext.	int.
44975-35	41x41x7,5	35,2x35,2x4,5
44975-50	57x57x9,5	51x51x6,3



**PPE**

**Extender**

Estensore  
Aufsatz  
Réhausse  
Extensión

art.	cm. ext.	int.
44975H35	41x41x7,5	35,2x35,2x7,5
44975H50	57x57x9,5	51x51x7,5x9,5







PPE

**Insulated container**

Contentitore isotermico  
Thermobehälter  
Conteneur isotherme  
Contenedor isotérmico

art.	cm.	lt.
44961-03	42x42x34,5	36

**With steam release system. For pizza boxes max 36x36 cm.** – Con sistema di rilascio del vapore. Per cartoni pizza max 36x36 cm.



PPE

**Insulated container with handle**

Contentitore isotermico con maniglia  
Thermobehälter mit Grill  
Conteneur isotherme avec manche  
Contenedor isotérmico con asa

art.	cm.	lt.
44961M03	42x42x34,5	36

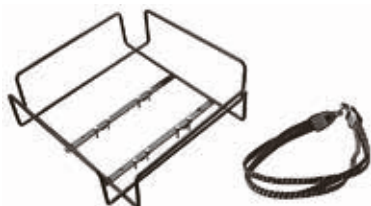

**Bike basket rack + elastic hook**

Cestello portapacco bike + gancio elastico  
Fahrradträgerkorb + elastischer Haken  
Porte-panier pour vélos + crochet élastique  
Canasta para bicicletas + gancho elástico

art.	cm.
44962-01	46x46x16

**With 8 self-locking screws. Max platform capacity 25 kg.** – Completo di 8 viti autobloccanti. Portata massima pianale 25 kg.



**Pizza delivery bag**

Borsa isotermica  
Thermo-Tasche  
Sac thermique  
Bolsa térmica

art.	cm.	cap.
44960-01	55x50x20	3xø45



**Pizza delivery bag**

Borsa isotermica  
Thermo-Tasche  
Sac thermique  
Bolsa térmica

art.	cm.	cap.
44960-04	46x44x20	4xø30



**Pizza delivery bag**

Borsa isotermica  
Thermo-Tasche  
Sac thermique  
Bolsa térmica

art.	cm.	cap.
44960-06	34x34x19,5xø33	
44960-07	42x42x19,4xø40	



**Pizza delivery bag**

Borsa isotermica  
Thermo-Tasche  
Sac thermique  
Bolsa térmica

art.	cm.	cap.
44960-02	46x46x12,2xø40	
44960-03	50x51x11,2xø45	



**Sandwich delivery bag**

Borsa isotermitica  
Thermo-Tasche  
Sac thermique  
Bolsa térmica

art. cm.  
44960-13 39x27x30



**Pizza delivery bag**

Borsa isotermitica  
Thermo-Tasche  
Sac thermique  
Bolsa térmica

art. cm.  
44960-10 51x46x41



**Pizza delivery bag**

Borsa isotermitica  
Thermo-Tasche  
Sac thermique  
Bolsa térmica

art. cm.  
44960-11 48x48x70



**Pizza delivery bag with rack**

Borsa isotermitica con rastrelliera  
Thermo-Tasche mit Gestell  
Sac thermique avec étagère  
Bolsa térmica con rack

art. cm. cap.  
44960K10 51x46x41 6xø45

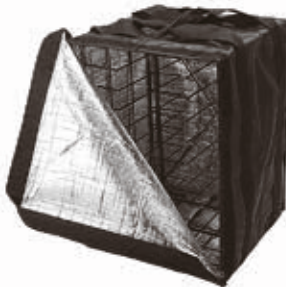

**Pizza delivery bag with rack**

Borsa isotermitica con rastrelliera  
Thermo-Tasche mit Gestell  
Sac thermique avec étagère  
Bolsa térmica con rack

art. cm. cap.  
44960K11 48x48x70 10xø45



**Pizza delivery backpack**

Zaino isotermitico  
Thermo-Rucksack  
Sac à dos thermique  
Mochila térmica

art. cm.  
44962-05 45x45x38

**Polyester and nylon. With inner PP insulaed container. For pizza boxes up to 35x35 cm. – Poliester e nylon. Interno con contenitore isotermitico in PP. Per scatole pizza fino a 35x35 cm.**





PP  
SS

**Dough scraper, flexible**

Tagliapasta flessibile  
Abstecher, flexibele  
Raclette flexible  
Cortapastas flexible

art. cm.  
18501-02 12x9,5



PP  
SS

**Dough scraper**

Tagliapasta  
Abstecher  
Raclette  
Cortapastas

art. cm.  
18501-01 12x16  
18501-03 13,5x10  
18501-04 12x9,5



PP  
SS

**Dough scraper**

Raschia  
Teigschäber  
Raclette  
Rasqueta

art. cm.  
18501-05 11x19,5



PP  
SS

**Dough scraper**

Raschia  
Teigschäber  
Raclette  
Rasqueta

art. cm.  
18502-18 18x9



PP  
SS

**Dough scraper**

Raschia  
Teigschäber  
Raclette  
Rasqueta

art. cm.  
18503-12 12x10



PP  
SS

**Dough scraper**

Raschia  
Teigschäber  
Raclette  
Rasqueta

art. cm.  
18504-15 15x7,5



PP  
SS

**Dough scraper**

Raschia  
Teigschäber  
Raclette  
Rasqueta

art. cm.  
18520-15 15x6



PA+  
plus

**Pizza ladle, flat bottom**

Mestolo pizza, fondo piatto  
Schöpföffel, flachboden  
Louche fond plat  
Cacillo fondo plano

art. Ø cm. l. cm.  
12968-10 10 27



PS

**Dough cutter**

Tagliapasta  
Teigschäber  
Raclette  
Rascador

art. cm.  
47621-11 10x24

**Shock and scratchproof material. Do not use on heat sources.** – Materiale antiurto e antigraffio. Non usare su fonti di calore.



PS

**Dough cutter**

Tagliapasta  
Teigschäber  
Raclette  
Rascador

art. cm.  
47621-12 13,5x14,5

**Shock and scratchproof material. Do not use on heat sources.** – Materiale antiurto e antigraffio. Non usare su fonti di calore.



PE

**Dough box**

Contenitore per impasti  
Behälter für Pizzateig  
Réceptier à pétrissage  
Contenedor para masa de pizza

art. cm. lt.  
41762-07 60x40x7,5 14  
41762-09 60x40x9,5 19  
41762-13 60x40x13 26



PE

**Cover for dough box**

Coperchio per contenitore  
Deckel für Pizzateig-Behälter  
Couvercle pour réceptier à pétrissage  
Tapa para contenedor

art. cm.  
41763-00 60x40



**Pizza screen, aluminum**  
Retina pizza, alluminio  
Pizzanetzscheibe, Aluminum  
Toile à pizza, aluminium  
Red para pizza, aluminio

art.	cm.
41734-60	60x40



**Pizza screen, aluminum**  
Retina pizza, alluminio  
Pizzanetzscheibe, Aluminum  
Toile à pizza, aluminium  
Red para pizza, aluminio

art.	Ø cm.
41727-28	28
41727-30	30
41727-33	33
41727-36	36
41727-40	40

**Without seam. – Senza giunzione.**



**Pizza screen, aluminum**  
Retina pizza, alluminio  
Pizzanetzscheibe, Aluminum  
Toile à pizza, aluminium  
Red para pizza, aluminio

art.	Ø cm.
41727-45	45
41727-50	50
41727-55	55
41727-60	60

**Without seam. – Senza giunzione.**



**SS**

**Pizza screen rack**  
Rastrelliera per retine  
Pizzanetzscheiben-Träger  
Etagère à toiles  
Rack para red para pizza

art.	cm.
41771-96	23x35,6

**Suitable for 96 screens.**  
Può contenere 96 retine.



**SS**

**Pizza pan rack**  
Rastelliera per teglie pizza  
Pizzableche-Träger  
Etagère pour plaques à pizza  
Rack para placas pizza

art.	cm.
41770-15	30,5x30,5x70

**Rails h.3,5 cm. for sheets up to Ø 36 cm.**  
Distanza piani cm 3,5, per teglie max ø 36 cm.



**Baking tray, alusteel**  
Teglia forno, acciaio alluminato  
Backblech mit Aluminumüberzug  
Plaque à pizza, tôle aluminée  
Placa pizza, acero aluminizado

art.	Ø cm.	h. cm.	U. Pack
11739-20	20	2,5	10
11739-24	24	2,5	10
11739-28	28	2,5	10
11739-32	32	2,5	10



**Pizza pan, heavy blue steel**  
Teglia pizza, ferro blu pesante  
Pizzablech, Blaublech, Schwerausführung  
Plaque à pizza, tôle forte bleuie  
Placa pizza, hierro pesante

art.	Ø cm.	h. cm.	U. Pack
11744-20	20	2,5	10
11744-24	24	2,5	10
11744-28	28	2,5	10
11744-32	32	2,5	10



**Pizza pan, perforated, non stick coated**  
Teglia pizza forata, antiaderente  
Pizzablech, gelocht, beschichtet  
Plaque à pizza perforée, anti-adhésive  
Placa pizza perforada, antiaderente

art.	Ø cm.	h. cm.
41729-30	29/27	1,5
41729-34	33/30	1,5



**Pizza pan double non stick-coating**  
Teglia pizza, antiaderente a 2 strati  
Pizzablech mit Doppel-Beschichtung  
Plaque à pizza, double revêtement  
Placa pizza antiaderente, 2 capas

art.	Ø cm.	h. cm.	U. Pack
11741-20	20	2,5	5
11741-24	24	2,5	5
11741-26	26	2,5	5
11741-28	28	2,5	5
11741-32	32	2,5	5

**Heat resistant up to 280°C. – Resistente a 280 °C.**





**Pizza pan, blue steel**

Teglia pizza, ferro blu  
Pizza-Blaublech  
Plaque à pizza, tôle bleuie  
Placa pizza, hierro

art.	Ø cm.	h. cm.	U. Pack
11740-14	14	2,5	5
11740-16	16	2,5	5
11740-18	18	2,5	5
11740-20	20	2,5	5
11740-22	22	2,5	5
11740-24	24	2,5	5



**Pizza pan, blue steel**

Teglia pizza, ferro blu  
Pizza-Blaublech  
Plaque à pizza, tôle bleuie  
Placa pizza, hierro

art.	Ø cm.	h. cm.	U. Pack
11740-26	26	2,5	5
11740-28	28	2,5	5
11740-30	30	2,5	5
11740-32	32	2,5	5
11740-36	36	2,5	5
11740-40	40	2,5	5



**Pizza pan, blue steel**

Teglia pizza, ferro blu  
Pizza-Blaublech  
Plaque à pizza, tôle bleuie  
Placa pizza, hierro

art.	Ø cm.	h. cm.	U. Pack
11742-16	16	3,5	10
11742-18	18	3,5	10
11742-20	20	3,5	10
11742-22	22	3,5	10
11742-24	24	3,5	10
11742-26	26	3,5	10
11742-28	28	3,5	10



**Pizza pan, blue steel**

Teglia pizza, ferro blu  
Pizza-Blaublech  
Plaque à pizza, tôle bleuie  
Placa pizza, hierro

art.	Ø cm.	h. cm.	U. Pack
11742-30	30	3,5	10
11742-32	32	3,5	5
11742-36	36	3,5	5
11742-40	40	3,5	5
11742-45	45	4,0	5
11742-50	50	4,0	5
11742-60	60	4,0	5



**Baking tray, blue steel, rectangular**

Teglia rettangolare, ferro blu  
Blaublech, rechteckig  
Plaque rectangulaire, tôle bleuie  
Placa rectangular, hierro

art.	cm.	h. cm.
41745-30	30x23	3
41745-35	35x28	3
41745-40	40x30	3
41745-50	50x35	3
41745-60	60x40	3
41745-65	65x45	3



**Baking tray, alusteel**

Teglia, alluminata  
Backblech, Aluminumüberzug  
Plaque rectangulaire, tôle aluminitée  
Placa rectangular, acero aluminizado

art.	cm.	h. cm.
41746-60	60x40	2



**Baking tray, alusteel**

Teglia, alluminata  
Backblech, Aluminiumüberzug  
Plaque rectangulaire, tôle aluminitée  
Placa rectangular, acero aluminizado

art.	cm.	h. cm.
41751-30	30x23	3
41751-35	35x28	3
41751-40	40x30	3
41751-50	50x35	3
41751-60	60x40	3
41751-65	65x45	3



**Baking tray, aluminum**

Teglia, alluminio  
Backblech, Aluminium  
Plaque à cuisson, aluminium  
Placa pastelería, aluminio

art.	cm.	GN
41744-32	53x32,5	1/1
41744-53	53x65	2/1
41744-60	60x40	-

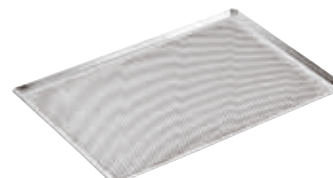

**Baking tray perforated, aluminum**

Teglia forata, alluminio  
Backblech, gelocht, Aluminium  
Plaque perforée, aluminium  
Placa perforada, aluminio

art.	cm.
41756-30*	30x40
41756-32	53x32,5
41756-53	53x65
41756-60	60x40

\* Open edges. – Angoli aperti.

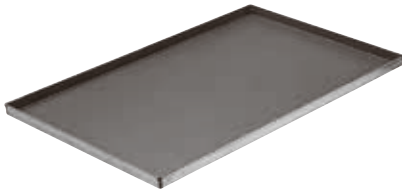

**Baking tray, non stick coated**

Teglia antiaderente  
Blech mit Antihafbeschichtung  
Plaque avec revêtement anti-adhésif  
Placa antiadherente

art.	cm.	h. cm.
41747-60	60x40	2



**Baking tray, non stick coated**

Teglia antiaderente  
Blech mit Antihafbeschichtung  
Plaque avec revêtement anti-adhésif  
Placa antiadherente

art.	Ø cm.	GN	pcs/pz
41755-11	12,5	1/1	6



**Baking tray, non stick coated**

Teglia antiaderente  
Blech mit Antihafbeschichtung  
Plaque avec revêtement anti-adhésif  
Placa antiadherente

art.	cm.	GN
41743-32	53x32,5	1/1
41743-53	53x65	2/1
41743-60	60x40	-



DEMARLE

**Baking tray, silicone coated**

Teglia siliconata  
Backblech Silikonbeschichtet  
Plaque avec revêtement silicone  
Placa siliconada

art.	cm.	GN
41743D32	53x32,5	1/1
41743D53	53x65	2/1
41743D60	60x40	-

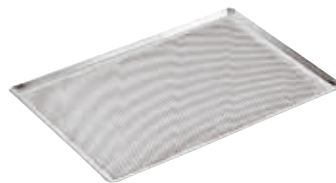

**Baking tray perforated, non stick coated**

Teglia forata, antiaderente  
Blech, gelocht mit Antihafbeschichtung  
Plaque perforée, revêtement anti-adhésif  
Placa perforada, antiadherente

art.	cm.	GN
41753-30*	30x40	-
41753-32	53x32,5	1/1
41753-53	53x65	2/1
41753-60	60x40	-

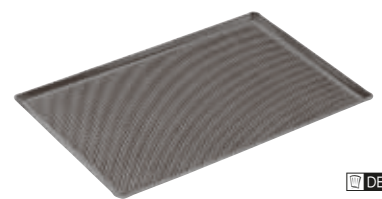

DEMARLE

**Baking tray perforated, silicone coated**

Teglia forata, siliconata  
Backblech, gelocht, Silikonbeschichtet  
Plaque perforée, revêtement silicone  
Placa perforada, siliconada

art.	cm.	GN
41753D30	30x40	-
41753D32	53x32,5	1/1
41753D53	53x65	2/1
41753D60	60x40	-

\* Open edges. – Angoli aperti.



**Baking tray, alusteel**

Teglia, alluminata  
Backblech, Aluminiumüberzug  
Plaque, tôle aluminitée  
Placa, acero aluminizado

art.	Ø cm.	cm.	pcs/pz
41752-08	14	60x40	8
41752-12	12	60x40	12
41752-24	12	60x80	24



# COFFEE SHOP CAFFETTERIA

BAR HAPPY HOUR







**Nitro Whip**  
Sifone nitro  
Nitrobereiter  
Siphon à nitro  
Sifón para Nitro

art.	lt.	des.
41452N10	1	Whip/Sifone
41452N16	-	16 chargers/ricariche

**Nitro Brew is on one of the fastest growing trends in the coffee business. Offer Nitro Coffee, Nitro Tea, and Nitro Cocktails to delight your guests table/barside. Adding Nitrogen (N2) to cold brew coffee and cocktails initiates a spectacular cascading effect, making the beverage unique, attractive, and personal. Nitrogen creates a velvety creamy texture and a long lasting foamy head for brews and cocktails.** – Infusi Nitro è una delle tendenze in rapida crescita nel settore del caffè. Offri Nitro Caffè, Nitro Te e Nitro Cocktails per deliziare i tuoi ospiti. Aggiungendo l'azoto (N2) per preparare caffè e cocktail a freddo, viene avviato uno spettacolare effetto a cascata, rendendo la bevanda unica, attraente e personale. L'azoto crea una consistenza vellutata e cremosa e una spuma di lunga durata per infusi e cocktail.



**Set of 10 stencils, plastic**  
Kit 10 mascherine, plastica  
Satz 10 Masken, kunststoff  
Set 10 pcs masques, plastique  
Juego 10 máscaras, plástico

art.	Ø cm.	h. cm.	lt.
47859-01	10	16	0,25



**Set of 10 stencils, plastic**  
Kit 10 mascherine, plastica  
Satz 10 Masken, kunststoff  
Set 10 pcs masques, plastique  
Juego 10 máscaras, plástico

art.	Ø cm.
47859-02	10



**Set of 4 stencils, plastic**  
Kit 4 mascherine, plastica  
Satz 4 Masken, kunststoff  
Set 4 pcs masques, plastique  
Juego 4 máscaras, plástico

art.	Ø cm.
47859-03	10





**Cocoa duster kit**

Kit spargicacao  
Kakaostreuer-Set  
Set glacière à cacao  
Juego dosificador cacao

art.	Ø cm.	h. cm.
42923-07	6,5	13



**Cocoa dredger**

Spargicacao  
Kakaostreuer  
Saupoudreuse à cacao  
Coctelera de cacao

art.	Ø cm.	h. cm.	ml.
41607-00	5,5	7,5	160



**Sugar pourer**

Spargizucchero  
Zuckerstreuer  
Saupoudreuse à sucre  
Dispensador de azúcar

art.	Ø cm.	Ø mm.	ml.
47023-01	7	1,5	300
47023-02	7	2,5	300
47023-03	7	5	300
47023-04	7	mesh	300



**Sugar pourer**

Spargizucchero  
Zuckerstreuer  
Saupoudreuse à sucre  
Dispensador azúcar

art.	Ø cm.	h. cm.	ml.
41525-01	8	15	250



**Sugar pourer**

Spargizucchero  
Zuckerstreuer  
Saupoudreuse à sucre  
Dispensador azúcar

art.	Ø cm.	h. cm.	ml.
42920-02	7,5	13,5	320



**Sugar pourer**

Spargizucchero  
Zuckerstreuer  
Saupoudreuse à sucre  
Dispensador azúcar

art.	Ø cm.	h. cm.	ml.
41645-00	7,5	17	320



**Honey/cream dispenser**

Dosatore miele/cremiera  
Sahne-/Honigkännchen  
Doseur pour miel/lait  
Dosificador para miel/leche

art.	Ø cm.	h. cm.	ml.
41525-00	8,5	13,5	300



**Milk frothing thermometers, 3 pcs**

Termometri latte/barista, 3 pz  
Mich-Thermometer, 3 Stk  
Thermomètres à lait, 3 pièces  
Termómetros leche, 3 pz

art.	Ø cm.	scala	range
49709-03	4,5	1°C	-10+110°C

**Red, green and blue, to easily identify different types of milk used, to avoid cross-contamination. Stem 175 mm.** – Rosso, verde e blu, per identificare facilmente i diversi tipi di latte utilizzati, per evitare la contaminazione incrociata. Stelo 175 mm.



**Milk pot with lid**

Lattiera con coperchio  
Milchgießer mit Deckel  
Pot à lait avec couvercle  
Jarra leche con tapa

art.	lt.
66303-01	0,15
66303-03	0,30
66303-06	0,60



**Cappuccino milk pot**

Lattiera cappuccino  
Capuccino-Milchkanne  
Pot à cappuccino  
Jarra cappuccino

art.	lt.
66307-06	0,6
66307-09	0,9
66307-12	1,2



**Spoon holder**

Porta cucchiaini  
Kaffeelöffelbehälter  
Porte cuillères  
Porta cucharas

art.	Ø cm.	h. cm.
66313-03	6	9



SS

**Straw holder**

Porta cannucce  
Röhrchenbehälter  
Porte chalumeaux  
Porta pajitas

art.	Ø cm.	h. cm.
66313-06	8	12



SS

**Sugar packet holder**

Portabustine zucchero  
Zuckertütenschale  
Porte-sachet de sucre  
Porta sobres de azúcar

art.	dim. cm.
66374-00	13x6x4



SS

**Sugar packet holder**

Portabustine zucchero  
Zuckertütenschale  
Porte-sachet de sucre  
Porta sobres de azúcar

art.	dim. cm.
44104-15	9x7,5x5

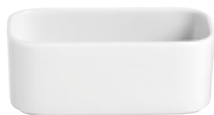

PR

**Sugar packet holder**

Portabustine zucchero  
Zuckertütenschale  
Porte-sachet de sucre  
Porta sobres de azúcar

art.	dim. cm.
67303-64	11x6x4



**Sugar packet holder**

Portabustine zucchero  
Zuckertütenschale  
Porte-sachet de sucre  
Porta sobres de azúcar

art.	dim. cm.	col.
44104-01	8,5x6,5x5	●
44104-02	8,5x6,5x5	○



AY

**Tea-box**

Scatola portabustine tè  
Teebox  
Boîte à sachets de thé  
Caja para bolsitas de tè

art.	dim. cm.
41614-22	22x17x9



W

**Tea-box**

Scatola portabustine tè  
Teebox  
Boîte à sachets de thé  
Caja para bolsitas de tè

art.	dim. cm.
41614-33	33,5x20x9
41614-35	31x28x9



W

**Tea-box**

Scatola portabustine tè  
Teebox  
Boîte à sachets de thé  
Caja para bolsitas de tè

art.	dim. cm.
41614-34	33,5x20x9
41614-36	31x28x9



PMMA

**Box With Lid**

Contentitore con coperchio  
Behälter mit Deckel  
Boîte avec couvercle  
Recipiente con tapa

art.	dim. cm.
41472-25	27,5x10,5x9,5

**Single compartment 8,5x8 cm.**  
Singolo comparto 8,5x8 cm.



PMMA

**Napkin holder**

Portatovaglioli  
Serviettenhalter  
Porte serviettes  
Servilletero

art.	dim. cm.
41472-12	18x6x10



PMMA

**Napkin holder**

Portatovaglioli  
Serviettenhalter  
Porte serviettes  
Servilletero

art.	dim. cm.
41472-13	18x6x11



SS

**Napkin holder**

Portatovaglioli  
Serviettenhalter  
Porte serviettes  
Servilletero

art.	dim. cm.
66391-00	10x3x8



SS

**Napkin holder**

Portatovaglioli  
Serviettenhalter  
Porte serviettes  
Servilletero

art. dim. cm.  
41602-00 17x3x7



SS

**Napkin holder**

Portatovaglioli  
Serviettenhalter  
Porte serviettes  
Servilletero

art. dim. cm.  
41601-17 8,5x11x12,5



**Napkin holder, chrome plated wire**

Portatovaglioli in filo cromato  
Serviettenhalter, Metall verchromt  
Porte-serviettes en fil chromé  
Servilletero en hilo cromado

art. dim. cm.  
41617-05 19x19x6,5



**Napkin holder, chrome plated wire**

Portatovaglioli in filo cromato  
Serviettenhalter, Metall verchromt  
Porte-serviettes en fil chromé  
Servilletero en hilo cromado

art. dim. cm.  
41617-15 19x19x19



**Napkin holder, chrome plated wire**

Portatovaglioli in filo cromato  
Serviettenhalter, Metall verchromt  
Porte-serviettes en fil chromé  
Servilletero en hilo cromado

art. dim. cm.  
41618-14 14x14x6,5



**Cash tray, 18 Cr s/s**

Vassoio conto, inox 18 Cr  
Rechnungstablett, Edelstahl 18 Cr  
Plateau porte-monnaie, inox 18 Cr  
Bandeja cuentas, acero 18 Cr

art. dim. cm.  
66318-19 19x14  
66318-22 22x15



SS

**Pastry stand 2-tier**

Alzata dolci, 2 piani  
Gebäckständer, 2-stufig  
Serviteur muet 2 étages  
Soporte dulces 2 niveles

art. Ø cm. h. cm.  
66339-02 12/16 20



**Serving stand, chrome plated**

Alzata cromata  
Serviergestell, Metall hartverchromt  
Présentoir chromé  
Soporte platos cromado

art. dim. cm.  
42962-26 18,5x15,5x26

For 3 plates max. Ø 17 cm, inside Ø 10,5 cm.  
Per 3 piatti max. Ø 17 cm, interno Ø 10,5 cm.



**Serving stand**

Alzata  
Serviergestell  
Présentoir  
Soporte platos

art. dim. cm.  
42962C26 18,5x15,5x26

For 3 plates max. Ø 17 cm, inside Ø 10,5 cm.  
Per 3 piatti max. Ø 17 cm, interno Ø 10,5 cm.





**W**

**Coffee set 4 pieces**

Servizio caffè 4 pezzi  
Kaffeaset 4 Stk  
Service à café 4 pièces  
Servicio de café 4 piezas

art. dim. cm.  
41206-03 25x18,7x2,5

**Acacia wood. – Acacia.**



**NEW**

**Serving stand 2-tier**

Alzata 2 piani  
Serviergestell, 2-stufig  
Présentoir 2 étages  
Soporte 2 niveles

art. dim. cm.  
41208-06 31x17x38

**Black metal frame with non-slip feet, 2 baskets 29x16x7 cm, 2 acacia wood boards 28,5x15,5x1,5 cm. – Struttura in metallo nero con piedini antiscivolo, 2 cesti cm 29x16x7, 2 assi in legno di acacia cm 28,5x15,5x1,5.**



**NEW**

**Serving stand 2-tier**

Alzata 2 piani  
Serviergestell, 2-stufig  
Présentoir 2 étages  
Soporte 2 niveles

art. Ø cm. h. cm.  
41208-02 22/26 48

**Wooden handle, metal black baskets Ø 22 H 6 cm and Ø 26 H 8 cm. – Manico legno, cesti in metallo nero Ø 22 H 6 cm e Ø 26 H 8 cm.**



**SS**

**Cake stand**

Alzata torta  
Tortenplatte  
Gueridon pâtissier  
Pedestal para tartas

art. Ø cm. h. cm.  
41538-30 30 5



**SS**

**Cake stand**

Alzata torta  
Tortenplatte  
Gueridon pâtissier  
Pedestal para tartas

art. Ø cm. h. cm.  
47099-30 30 10



**SS**

**Swivel cake stand**

Alzata torta girevole  
Tortenplatte drehbar  
Gueridon pâtissier tournante  
Pedestal giratorio para tartas

art. Ø cm. h. cm.  
47101-31 30,5 9

**Rotating plate. Fits to: 41414-31.  
Piatto rotante. Per art.: 41414-31.**



**MF**

**Cake stand**

Alzata torta  
Tortenplatte  
Gueridon pâtissier  
Pedestal para tartas

art. dim. cm.  
44874-08 31x31x8  
44874-16 31x31x16



**PS**

**Dome cover**

Cloche  
Abdeckehaube  
Cloche  
Campana

art. Ø cm. h. cm.  
41414-30 30 9,5

**Fits to/Per art.: 44845-31, 47101-31.**



**MF**

**Round dish**

Piatto tondo  
Platte, rund  
Plat rond

**Bandeja redonda**  
art. Ø cm. h. cm.  
44845-38 38 2





SAN

**Roll-top cover**

Coperchio roll-top  
Rolltophaube  
Couvercle roll-top  
Campana roll-top

art.	Ø cm.	h. cm.
41447-38	38	20

Fits to/Per art.: 44845-38.



NEW



MF

**Cake tray**

Piatto torta  
Tortenplatte  
Plat gâteau

**Bandeja pasteles**

art.	Ø cm.	h. cm.
44845-21	21,5	2,5
44845-31	31,0	3,5
44845-39	37,5	4,0

With non-slip feet. With carved edge fixing the cover. – Con piedini antiscivolo. Con bordo fissa-coperchio.



NEW



MF

**Cake stand**

Alzata torta  
Tortenplatte  
Gueridon pâtissier  
Pedestal para tartas

art.	Ø cm.	h. cm.
44873-06	21,5	9
44873-08	30,5	9
44873-10	37,5	9

With non-slip feet. With carved edge fixing the cover. – Con piedini antiscivolo. Con bordo fissa-coperchio.



NEW



MF

**Cake stand**

Alzata torta  
Tortenplatte  
Gueridon pâtissier  
Pedestal para tartas

art.	Ø cm.	h. cm.
44873-15	21,5	17
44873-16	30,5	17
44873-17	37,5	17

With non-slip feet. With carved edge fixing the cover. – Con piedini antiscivolo. Con bordo fissa-coperchio.



NEW



PC

**Dome cover**

Campana  
Haube  
Cloche  
Campana

art.	Ø cm.	h. cm.
41414-21	21	17

Fits to/Per art.: 44475-82, 44475-83, 44474-24, 44474-25.



PC

**Dome cover**

Campana  
Haube  
Cloche  
Campana

art.	Ø cm.	h. cm.
41414-31	30	22

Fits to/Per art.: 41586-33, 41587-32, 44475-79, 44845-31, 44873-08, 44873-16, 47101-31, 44474-33, 44474-34.



NEW



PC

**Dome cover**

Campana  
Haube  
Cloche  
Campana

art.	Ø cm.	h. cm.
41414-36	36	27

Fits to/Per art.: 44474-38, 44474-39, 44470-38.



**NEW**



**PC**

**Dome cover**

Campana  
Haube  
Cloche  
Campana

art.	Ø cm.	h. cm.
41413-30	30	40

**Fits to/Per art.: 44845-31, 44873-08, 44873-16, 44474-33, 44474-34.**



**NEW**

**W**



**Cake stand**

Alzata torta  
Tortenplatte  
Gueridon pâtissier  
Pedestal para tartas

art.	Ø cm.	h. cm.
44474-09	9,5	7
44474-13	13,0	9

**Acacia wood. – Legno d'acacia.**



**NEW**

**W**



**Cake stand**

Alzata torta  
Tortenplatte  
Gueridon pâtissier  
Pedestal para tartas

art.	Ø cm.	h. cm.	fits/per
44474-24	24	8	41414-21
44474-33	33	8	41414-31
44474-38	38,5	8	41414-36

**Acacia wood. – Legno d'acacia.**



**NEW**

**W**



**Cake stand**

Alzata torta  
Tortenplatte  
Gueridon pâtissier  
Pedestal para tartas

art.	Ø cm.	h. cm.	fits/per
44474-25	24	16	41414-21
44474-34	33	16	41413-30
44474-39	38,5	16	41414-36

**Acacia wood. – Legno d'acacia.**





**Cake stand**  
Alzata torta  
Tortenplatte  
Gueridon pâtissier  
Pedestal para tartas

art.	Ø cm.	h. cm.
44475-80	11,5-15	10,5
44475-82	15-21	20,0



**Cake stand**  
Alzata torta  
Tortenplatte  
Gueridon pâtissier  
Pedestal para tartas

art.	Ø cm.	h. cm.
44475-81	11,5-15	10,5
44475-83	21-15	20,0



**Tray with dome cover**  
Vassoio con campana  
Tablett mit Haube  
Plat avec cloche  
Bandeja con campana

art.	Ø cm.	h. cm.
41416-18	18,5	24,5

**Beech wood tray with glass cover Ø 16 H 22,5 cm.** – Vassoio in legno di faggio con coperchio in vetro Ø 16 H 22,5 cm.



**Display case**  
Vetrina brioches  
Vitrine für Brioches  
Vitrine brioches  
Vitrina brioches

art.	dim. cm.
41472-32	37x31x31

**1 door, 3 shelves, H 10 cm.** – 1 porta, 3 piani H 10 cm.

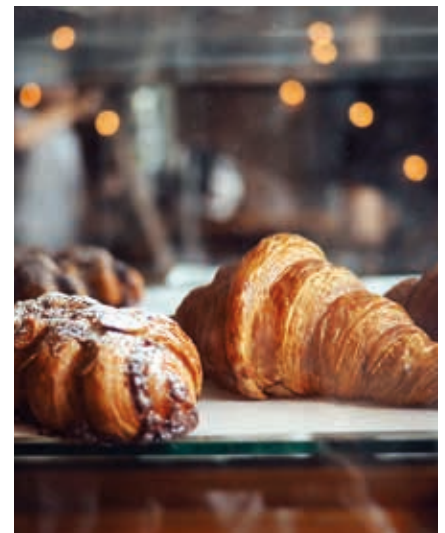

**Showcase**  
Vetrina da banco  
Vitrine für Verkaufstheke  
Vitrine à comptoir  
Vitrina

art.	dim. cm.
47091-01	44x32x20,5

**Double side opening. Incl. s/s trays 39x28 cm, 4 coolers.** – Apertura doppio fronte. Con vassoio inox 39x28 cm, 2 eutettici.



**Showcase, 2-tier**  
Vetrina da banco, 2 piani  
Vitrine für Verkaufstheke, doppeldecker  
Vitrine à comptoir, 2 étages  
Vitrina, doble

art.	dim. cm.
47091-02	44x32x44

**Double side opening. Incl. s/s tray 39x28 cm, 2 coolers.** – Apertura doppio fronte. Con vassoio inox 39x28 cm, 4 eutettici.



**Sweet box**  
Contentitore universale  
Universalbox  
Boîte à comptoir  
Exibidor

art.	dim. cm.
47090-23	23x14,5x15





**NEW**  
**AY**

**Counter showcase**

Vetrina da banco  
Thekendisplay  
Vitrine de comptoir  
Vitrina de mostrador

art.	GN	dim. cm.
41472-56	1/1	56x33x21

**With non-slip feet. Removable side panels.**  
Con piedini antiscivolo. Pannelli laterali removibili.



**NEW**  
**AY**

**Counter showcase**

Vetrina da banco  
Thekendisplay  
Vitrine de comptoir  
Vitrina de mostrador

art.	dim. cm.	h. cm.
41472-55	56x20	21

**With non-slip feet. Removable side panels.**  
Con piedini antiscivolo. Pannelli laterali removibili.



**NEW**  
**AY**

**Counter showcase**

Vetrina da banco  
Thekendisplay  
Vitrine de comptoir  
Vitrina de mostrador

art.	dim. cm.	h. cm.
41472-80	82,5x33	22,5
41472-99	102,5x33	25,5

**With non-slip feet. Removable side panels.**  
Con piedini antiscivolo. Pannelli laterali removibili.





# ICE CREAM GELATERIA

BAR HAPPY HOUR





SS

**Ice cream container**

Bacinella per gelato  
Eisbehälter  
Réceptient à glace  
Cubeta helado

art.	dim. cm.	lt.
41487-12	26x16x12	3,5
41487-15	26x16x15	4,1
41487-17	26x16x17	4,5



SS

**Ice cream container**

Bacinella per gelato  
Eisbehälter  
Réceptient à glace  
Cubeta helado

art.	dim. cm.	lt.
41471-12	36x16,5x12	5,0
41471-15	36x16,5x15	6,5
41471-17	36x16,5x17	7,5



SS

**Ice cream container**

Bacinella per gelato  
Eisbehälter  
Réceptient à glace  
Cubeta helado

art.	dim. cm.	lt.
41486-08	36x25x8	5
41486-12	36x25x12	8
41486-15	36x25x15	10



PC

**Ice cream container**

Bacinella per gelato  
Eisbehälter  
Réceptient à glace  
Cubeta helado

art.	dim. cm.	lt.
41431-12	36x16,5x12	5,4



PC

**Ice cream container**

Bacinella per gelato  
Eisbehälter  
Réceptient à glace  
Cubeta helado

art.	dim. cm.	lt.
41431-08	36x25x8	5,0



PMMA

**Lid for ice cream container**

Coperchio per bacinella gelato  
Deckel für Eisbehälter  
Couvercle pour réceptient à glace  
Tapa para cubeta helado

art.	dim. cm.
41471-00	36x16,5



PC

**Lid for ice cream container**

Coperchio per bacinella gelato  
Deckel für Eisbehälter  
Couvercle pour réceptient à glace  
Tapa para cubeta helado

art.	dim. cm.
41486-00	36x16,5
41486-01	36x25



SS

**Ice cream basin**

Carapina  
Eisbehälter  
Réceptient à glace  
Cubeta helado

art.	Ø cm.	h. cm.	lt.
41489-20	20	25	7,3



SS

**Ice cream server**

Spatola gelato carapina  
Eisspachtel  
Palette à glace  
Paleta helados

art.	col.
41475-20	○



SS

**Ice cream server**

Spatola gelato  
Eisspachtel  
Palette à glace  
Paleta helados

art.	l. cm.	col.
41475-00	27	○
41475-01	27	●
41475-03	27	●
41475-04	27	●
41475-05	27	●



**Ice-dipper**

Spatola gelato  
Eisdipper  
Cuillère à glace  
Cuchara helados

art.	Ø mm.	lt.
41468-20	55	1/20
41468-24	50	1/24

**With liquid heat conductor in the handle.**  
Con liquido conduttore nel manico.



**Ice-dipper**

Spatola gelato  
Eisdipper  
Cuillère à glace  
Cuchara helados

art.	Ø mm.	lt.
41469-20	55	1/20
41469-24	50	1/24

**With liquid heat conductor in the handle.**  
Con liquido conduttore nel manico.





SS

**Ice cream scoop**

Porzionatore  
Eisportionierer  
Cuillère à glace  
Racionador de helado

art.	Ø mm.	lt.
41476-50	50	1/24

**Non slip handle. – Manico antiscivolo.**



SS

**Ice cream scoop**

Porzionatore  
Eisportionierer  
Cuillère à glace  
Racionador de helado

art.	Ø mm.	lt.
41473-31	30	1/100
41473-39	38	1/65
41473-44	43	1/50
41473-50	50	1/24
41473-56	55	1/20
41473-62	60	1/14
41473-66	66	1/12



**Ice cream scoop**

Porzionatore  
Eisportionierer  
Cuillère à glace  
Racionador de helado

art.	Ø mm.	lt.
41488-45	45	1/40
41488-47	47	1/36
41488-50	50	1/30
41488-53	53	1/24

**Nylon, fiberglass. Stainless steel mechanism.**  
Meccanismo in acciaio inox.



SS

**Oval ice cream scoop**

Porzionatore ovale  
Eisportionierer, oval  
Cuillère à glace ovale  
Racionador de helado oval

art.	Ø mm.	lt.
41474-00	60	1/30



SS

**Triangle ice cream scoop**

Porzionatore triangolare  
Eisportionierer, dreieckig  
Cuillère à glace triangle  
Racionador de helado triangular

art.	lt.
41474-02	1/30



**Decorative scrapers 5 pcs**

Raschietti decorativi 5 pezzi  
Dekorative Schaber 5 Stk  
Raclettes décoratives 5 pcs  
Rasquetas decorativas 5 pz

art.	dim. cm.
41472-43	14,5x15

**PETG.**



**Chalkmarker**

Penna a gesso liquido  
Kreidestifte  
Stylo à craie liquide  
Marcadores de tiza líquida

art.	col.
47832-01	●
47832-03	●
47832-04	●
47832-05	●

**Writes on all non porous surfaces. Clean with water. – Scrive su tutte le superfici non porose. Pulire con acqua.**



PMMA

**Flavour marker holder 10 pcs**

Porta segnagusto 10 pezzi  
Eisschilderhalter 10 Stk  
Porte-étiquettes 10 pièces  
Porta etiquetas 10 pz

art.	mm.
41472-46	87x52

**Labels not included. – Cartellino non incluso.**



PMMA

**Flavour marker 10 pcs**

Segnagusto 10 pezzi  
Eisschilder 10 Stk  
Étiquettes 10 pièces  
Etiquetas sabores 10 pz

art.	mm.
41472-44	190x85





PMMA

**Flavour marker**

Segnagusto  
Eisschilder  
Etiquette de saveur  
Etiqueta sabor

art. mm.  
41472-45 150x70



SS

**Counter ice cream cone holder**

Porta coni da banco  
Theke-Eiswaffelständer  
Porte cornets à glace de comptoir  
Expositor para cucuruchos

art. Ø cm. h. cm.  
41472-04 16,5 14



PMMA

**Counter ice cream cone holder**

Porta coni da banco  
Theke-Eiswaffelständer  
Porte cornets à glace de comptoir  
Expositor para cucuruchos

art. Ø mm. dim. cm.  
41472-07 3,5 21x8,5x11  
41472-08 3,5 28,5x8,5x11



SS

**Counter ice cream cone holder**

Porta coni da banco  
Theke-Eiswaffelständer  
Porte cornets à glace de comptoir  
Expositor para cucuruchos

art. dim. cm.  
41472-01 20x9,5x8,5



PMMA

**Paper napkins holder**

Porta tovaglioli  
Serviettenhalter  
Porte serviettes  
Porta servilletas

art. dim. cm.  
41472-12 18x6x10



PMMA

**Paper napkins holder**

Porta tovaglioli  
Serviettenhalter  
Porte serviettes  
Porta servilletas

art. dim. cm.  
41472-13 18x6x11



PP

AY

PP

**Universal box**

Contenitore universale  
Universalbox  
Conteneur à comptoir  
Recipiente universal

art. dim. cm.  
47090-23 23x14,5x15





PMMA

**Box with lid**

Contentore con coperchio  
Behälter mit Deckel  
Boîte avec couvercle  
Recipiente con tapa

art. dim. cm.  
41472-25 27,5x10,5x9,5

**Compartments size 8,5x8 cm.**  
Dimensione scomparti 8,5x8 cm.



PMMA

**Box with lid**

Contentore con coperchio  
Behälter mit Deckel  
Boîte avec couvercle  
Recipiente con tapa

art.	Ø mm.	h. cm.
41472-26	10	15
41472-27	12	15
41472-28	15	15
41472-29	18	15



PMMA

**Waffle case**

Contentore per cialde  
Waffelbehälter  
Porte gaufres  
Dispensador waffles

art. dim. cm.  
41472-21 22x26x12



PMMA

**Spoon case**

Contentore per palette  
Eislöffelbehälter  
Porte cuillères à glace  
Dispensador cucharillas de helado

art. dim. cm.  
41472-20 19x12,5x14



PMMA

**Straws case**

Contentore per cannuccie  
Strohalmbehälter  
Porte chalumeaux  
Dispensador pajitas

art. dim. cm.  
41472-22 26x17x22



PMMA

**Cone holder, front opening**

Porta coni, apertura frontale  
Eiswaffelbehälter mit Frontöffnung  
Porte cornets à glace, ouverture frontale  
Porta cucurucho, abertura frontal

art. dim. cm.  
41472-16 11x13x50



PMMA

**Spoon and cup holder**

Porta palette e coppette  
Eislöffel und Schalenbehälter  
Porte cuillères et pots  
Porta cucharillas y copas

art. dim. cm.  
41472-17 28x25x55



PMMA

**Cone holder 6 holes with spoon drawer**

Porta coni 6 fori c/porta palette  
Eiswaffelspender, 6 Löcher mit Palettenhalter  
Porte cornets 6 trous, porte cuillères  
Porta cucurucho/cucharillas, 6 orificios

art. dim. cm.  
41472-18 25,5x18x60,5

**Upper hole Ø 3,5 cm. Lower Ø 2 cm. Distance between holes Ø 4,5 cm. Removable lower drawer.** – Foro superiore Ø 3,5 cm. Inferiore Ø 2 cm. Distanza tra i fori Ø 4,5 cm. Cassetto inferiore estraibile.



PMMA

**Cone holder 12 holes**

Porta coni 12 fori  
Eiswaffelspender, 12 Löcher  
Porte cornets 12 trous  
Porta cucurucho 12 orificios

art. dim. cm.  
41472-24 33x25x50

**Upper hole Ø 5,2 cm. Lower Ø 2 cm.**  
Foro superiore Ø 5,2 cm. Inferiore Ø 2 cm.





PMMA

**Swivel cone holder 5 sections**  
Porta coni rotante 5 sezioni  
Eiswaffelspender, drehbar, 5 Fächer  
Porte cornets rotatif, 5 comp  
Porta cucurucho giratorio 5 secciones

art. Ø cm. h. cm.  
41472-23 25 50

**Upper hole Ø 3,5 cm. Lower Ø 2 cm. Distance between holes Ø 4,5 cm.** – Foro superiore Ø 3,5 cm. Inferiore Ø 2 cm. Distanza tra i fori Ø 4,5 cm.



PMMA

**Cone holder with door**  
Porta coni con porta  
Eiswaffelspender mit Tür  
Porte cornets ouverture frontale  
Porta cucurucho, abertura frontal

art. dim. cm.  
41472-19 33x18x50



PMMA

**Horizontal cone holder with door**  
Porta coni orizzontale con porta  
Eiswaffelspender horizontal mit Tür  
Porte cornets à glace horizontal  
Porta cucurucho horizontal

art. Ø cm. dim. cm.  
41472-14 30 42x37x40,5

**With removable divider.** – Con divisorio estraibile.



PMMA

**Revolving cones dispenser**  
Porta coni girevole  
Eiswaffelspender, drehbar  
Porte-cornets pivotant  
Distributor giratorio de cucurucho

art. Ø cm. h. cm.  
41472-15 24 78



MS

**Ice cream cup**  
Coppa gelato  
Eisbecher  
Coupe à glace  
Copa helado

art. h. cm. lt. U. Pack  
44942-12 6,5 0,26 6



MS

**Ice cream cup**  
Coppa gelato  
Eisbecher  
Coupe à glace  
Copa helado

art. h. cm. lt. U. Pack  
44942-11 11 0,38 6



MS

**Ice cream cup**  
Coppa gelato  
Eisbecher  
Coupe à glace  
Copa helado

art. h. cm. lt. U. Pack  
44942-10 16 0,25 6



SMMA

**Ice cream cup**  
Coppa gelato  
Eisbecher  
Coupe à glace  
Copa helado

art. Ø cm. h. cm. U. Pack  
44942-06 10 10 6



SMMA

**Ice cream cup**  
Coppa gelato  
Eisbecher  
Coupe à glace  
Copa helado

art. Ø cm. h. cm. U. Pack  
44942-07 9 19 6



MF

**Gourmet bowl**  
Ciotolina Gourmet  
Schälchen Gourmet  
Bol Gourmet  
Bol Gourmet

art.	Ø cm.	h. cm.	ml.
44466-07	7	6	50



MF

**Gourmet tray**  
Vassoio Gourmet  
Tablett Gourmet  
Plateau Gourmet  
Bandeja Gourmet

art.	dim. cm.
44466-30	30,5x9,5x2,5

COMPOSTABLE - COMPOSTABILI



An eco-friendly version of disposable items. Suitable both for pastry shops and events. Made of PLA, a revolutionary compostable and patented biopolymer that originates from plants and produced in a natural way.

Versione ecologica che rispetta l'ambiente. Realizzati in PLA, un rivoluzionario biopolimero compostabile e brevettato, derivato da piante e prodotto in modo naturale. Adatti sia nelle pasticcerie che per eventi.



**Glass**  
Bicchierino  
Glas  
Verrine  
Vaso

art.	Ø cm.	h. cm.	ml.
48373-06	4,2	6,5	65
48373-09	5,0	6,5	90
48373-12	5,5	7,0	120
48373-17	6,0	9,0	170

Pcs/Conf. 100 pz.



NATURAL ELEGANT



A valid alternative to glass. Elegant and unbreakable ideals for HORECA pastry and ice cream sector. Made with high quality material that confers beside resistance also glossiness and perfect transparency. Bisphenol free. Thermal tolerance -18°C +70°C. 100% recyclable material. Dishwasher safe: up to 50 washes. Made in Italy.

La valida alternativa al vetro. Eleganti ed infrangibili ideali per il settore HORECA della pasticceria e gelateria. Realizzati con materiale di alta qualità che gli conferisce oltre alla resistenza anche lucidità e trasparenza. Privi di Bisfenolo. Tolleranza termica -18°C +70°C. Materiale riciclabile al 100%. Lavabili in lavastoviglie: fino a 50 lavaggi. Prodotti made in Italy.



**Bowl**  
Coppetta  
Schale  
Coupe  
Copa

art.	Ø cm.	h. cm.	ml.
48367-10	7	5,9	105

Pcs/Conf. 100 pz.



**Glass**  
Bicchierino  
Glas  
Verrine  
Vaso

art.	dim. cm.	ml.
48371-10	7,3x6,4x5,2	100
48371-11	lid/coperchio	-

Pcs/Conf. 100 pz.



**PS**

**Cup**  
Coppetta  
Schale  
Coupelle  
Bol

art.	Ø cm.	h. cm.	ml.
48365-09	9	7,5	175

**Pcs/Conf. 100 pz.**



**Glass**  
Bicchierino  
Glas  
Verrine  
Vaso

art.	Ø cm.	h. cm.	ml.
48370-10	7,8	5,7	210
48370-11	lid/coperchio	-	-

**Pcs/Conf. 100 pz.**



**PS**

**Cup**  
Coppetta  
Schale  
Coupelle  
Bol

art.	Ø cm.	h. cm.	ml.
48366-09	9	7,5	125

**Pcs/Conf. 100 pz.**



**PS**

**Glass**  
Bicchierino  
Glas  
Verrine  
Vaso

art.	Ø cm.	h. cm.	ml.
48354-01	4	8,5	70

**Pcs/Conf. 100 pz.**



**PS**

**Glass**  
Bicchierino  
Glas  
Verrine  
Vaso

art.	Ø cm.	h. cm.	ml.
48350-01	4,2	6,5	50
48350-02	5,0	6,5	80
48350-03	5,5	7,0	100
48350-04	6,0	9,0	160

**Pcs/Conf. 100 pz.**



**PS**

**Glass**  
Bicchierino  
Glas  
Verrine  
Vaso

art.	Ø cm.	h. cm.	ml.
48353-01	8,5	6,5	120

**Pcs/Conf. 100 pz.**





PS

**Glass**  
Bicchierino  
Glas  
Verrine  
Vaso

art.	dim. cm.	ml.
48351-01	4x4x5,5	50
48351-02	5x5x7	100
48351-03	5,5x5,5x8	150

**Pcs/Conf. 100 pz.**



PS

**Glass**  
Bicchierino  
Glas  
Verrine  
Vaso

art.	Ø cm.	h. cm.	ml.
48352-01	6,5	5,5	70
48352-02	7,0	6,7	120
48352-03	7,5	7,3	150

**Pcs/Conf. 100 pz.**



**Ice tube mold**  
Stampo gelato  
Eisform  
Moule à glace  
Molde helado

art.	ml.
41472-36	150

**Pcs/Conf. 100 pz.**



PMMA

**Ice cream counter display**  
Espositore per vetrina gelato  
Ständer für Eiscremetheke  
Présentoir de comptoir  
Expositor helados

art.	dim. cm.	holes/fori
41472-34	25x36x4,5	21
41472-35	16x36x4,5	15

**For mold/Per stampo: 41472-36.**



PMMA

**Holder for blast chiller**  
Supporto per abbattitore  
Ständer für Schnellabkühler  
Présentoir à cellule de refroidissement  
Soporte para abatidor

art.	dim. cm.	holes/fori
41472-33	29x39x12	28

**For mold/Per stampo: 41472-36.**



**Mini push up pops**

Stampi mini push up pops  
Mini push up pops Eisformen  
Moules à mini push up pops  
Mini push up pops moldes

art.	Ø cm.	h. cm.	ml.
41472-37	4,0	18,8	90
41472-38	3,5	19,6	50

**Pcs/Conf. 100 pz.**



**PMMA**

**Ice cream counter display**

Espositore per vetrina gelato  
Ständer für Eiscremetheke  
Présentoir de comptoir  
Expositor helados

art.	dim. cm.	holes/fori
41472-39	25x36x4	21
41472-40	16x36x4	15

**For molds/Per stampi: 41472-37 - 41472-38.**



**PMMA**

**Display for mini ice cream cones**

Espositore per mini cornetti  
Waffelhörnchen-Ständer  
Présentoir à mini cornet à glace  
Expositor mini conos helado

art.	Ø cm.	dim. cm.	holes/fori
41472-41	1,8	36x16,5	27
41472-42	1,8	36x25	45

**Suitable for all waffle minicones on the market.**  
Per tutti i miniconi in cialda in commercio.



**Ice cream mold, silicone**

Stampo gelato su stecco, silicone  
Eisform, Silikon  
Moule à glace, silicone  
Molde helado, silicona

art.	mm.	ml.	pcs/pz
41472-47	44x22x93	78	12

**Kit 2 molds of 6 pcs with white plastic tray and 50 pcs wooden sticks.** – Kit 2 stampi da 6 pz con vassoio in plastica e 50 bastoncini legno.



**PMMA**

**Ice cream counter display**

Espositore per vetrina gelato  
Ständer für Eiscremetheke  
Présentoir de comptoir  
Expositor helados

art.	dim. cm.	pcs/pz
41472-48	36x25x5	24

**For mold/Per stampo: 41472-47.**



**Tray with cover**

Vassoio con coperchio  
Tablett mit Deckel  
Plateau avec couvercle  
Bandeja con tapa Cm 59X39X8

art.	dim. cm.
41472-50	59x39x8

**Unbreakable, shock resistant even at very low temperatures.** – Infrangibile, resistente agli urti anche a bassissime temperature.



**ABS**

**Tempering unit**

Temperatrice  
Temperiergerät  
Tempereuse  
Templadora

art.	Ø cm.	h. cm.	lt.
47698-01	20,5	21,2	1,7

**Ideal for chocolate coatings of ice creams on sticks. Removable anodized aluminum tank.**  
Ideale per coperture in cioccolato di gelati e semifreddi su stecco. Vasca estraibile in alluminio anodizzato.



ABS

**Tempering unit**

Temperatrice  
Temperiergerät  
Tempereuse  
Templadora

art.	Ø cm.	h. cm.	lt.
47698-02	26	16	1,8

**Allows to process tiny chocolate quantities without any waste. Removable tank.**

Adatto per piccole produzioni senza sprechi. Pratica vasca estraibile.



KAYSER SS

**Professional cream whipper**

Sifone panna professionale  
Profi-Sahnebereiter  
Siphon à crème professionnel  
Sifón montador de nata profesional

art.	lt.
41451-05	0,5
41451-10	1,0



**Cream chargers, 10-pcs set**

Ricariche panna montata, conf. 10 pezzi  
10-Stk. Sahnekapseln-Packung  
Capsules à crème Chantilly, set 10 pièces  
Cápsulas para nata, 10 piezas

art.
41450-AA

**Contains N2O under pressure.**  
Contiene N2O sotto pressione.



SS

**GOURMET-Cream whipper**

Sifone panna  
Sahnebereiter  
Siphon à crème  
Sifón para nata montada

art.	lt.
41458-02	0,25
41458-05	0,50
41458-10	1,00

**Heat resistant silicone gasket. Keep warm in bain marie up to 75°C.**

Guarnizione in silicone resistente al calore. Tenere a bagnomaria max. a 75°C.



SS

**THERMO-Cream whipper**

Sifone termico  
Thermo-Sahnebereiter  
Siphon à crème, isotherme  
Sifón isotérmico

art.	lt.
41455T55	0,5

**Double-walled, insulated bottle: keeps creations cold for 8 hours and hot for 3 hours, dishwasher-safe. – Bottiglia termica, mantiene le preparazioni in caldo fino a 3 ore e a freddo fino a 8 ore.**



SS

**THERMO SPRESS-Cream whipper**

Sifone termico  
Thermo-Sahnebereiter  
Siphon à crème, isotherme  
Sifón isotérmico

art.	h. cm.	lt.
41459-10	35	1

**Double-walled, insulated bottle, keeps creations cold for 8 hours and hot for 3 hours. – Bottiglia termica, mantiene le preparazioni in caldo fino a 3 ore e a freddo fino a 8 ore, lavabile in lavastoviglie.**



SS

**PROFI-Cream whipper**

Sifone panna  
Sahnebereiter  
Siphon à crème  
Sifón para nata montada

art.	lt.
41460-05	0,5
41460-10	1,0

**Only for cold preparations.**  
Solo per preparazioni fredde.



**Decorating tips, 3-pcs set**

Bocchette, set 3 pezzi  
Dekorationstüllen, 3er Set  
Douilles de décoration, 3 pièces  
Boquillas de decoración, 3 piezas

art.
41455-BC



SS

**Decorating tips, 3-pcs set**

Bocchette, set 3 pezzi  
Dekorationstüllen, 3er Set  
Douilles de décoration, 3 pièces  
Boquillas de decoración, 3 piezas

art.
41458-23





**Decorating tips and adapter**

Bocchette decoro e adattatore  
Dekorationstüllen-Set u. Adapter  
Douilles de décoration et adaptateur  
Boquillas de decoración y adaptador

art. 41458-24



**Injector needles**

Iniettori/siringhe decoro  
Nadeltüllen  
Aiguilles d'injection  
Boquillas de aguja

art. 41458-21



**Heat protector, silicone**

Protezione in silicone  
Silikonhülle  
Housse en silicone  
Protección de silicona

art.	lt.
41458-50	0,5
41458-51	1,0



**Cream chargers, PROFESSIONAL**

Ricariche panna montata, PROFESSIONAL  
Sahnekapself-Packung, PROFESSIONAL  
Capsules à crème Chantilly, PROFESSIONAL  
Cápsulas para nata, PROFESSIONAL

art.	pcs/pz
41455-CA	24
41455-CB	50

**Filled with 8,4 g of N2O (E942, nitrous oxide).**  
Contenuto: 8,4 g di N2O (E942 protossido di azoto).



**Funnel and sieve**

Imbuto e colino  
Trichter und Sieb  
Entonnoir et tamis  
Embudo y tamiz

art. 41458-11



**Kit rapid infusion**

Kit di infusione rapida  
Rapid Infusion Set  
Paquet rapid infusion  
Rapid infusion set

art. 41458-25

**Enables a liquid to be infused with different flavors in the shortest possible time. First, combine aromatic solids (e.g. herbs, spices, fruit) and a liquid (e.g. alcohol, oil, water, vinegar) in the whipper then apply pressure into it using a cream charger.** – Permette di infondere un liquido con sapori diversi in tempo rapido. Unire gli aromi solidi (erbe, spezie, frutta, ecc.) con il liquido (alcol, olio, acqua, aceto, ecc.) nel sifone ed immettere una carica per panna.





# COCKTAIL BAR

BAR HAPPY HOUR



Paderno offers a wide selection of bar equipment, designed to combine easy use with efficiency and style. The tools are flanked by fascinating accessories making every moment trendy and lively. To share refined happy hours, to enjoy spectacular cocktails and long drinks, or to add style to every sort of drink.

Paderno propone un'ampia selezione di attrezzature bar, ideata per unire praticità d'utilizzo a efficienza e stile. Agli utensili si affiancano affascinanti accessori in grado di rendere trendy e vivace ogni momento. Per condividere raffinati happy hour, per gustare scenografici cocktail e long drink, oppure per aggiungere stile a ogni tipo di bevanda.





SS

**Pumpkin mug**

Coppa zucca  
Kürbis-Becher  
Gobelet citrouille  
Vaso de calabaza

art.	Ø cm.	h. cm.	ml.	col.
44944G07	10	14,5	700	●
44944C07	10	14,5	700	●



SS

**Pineapple cup**

Coppa ananas  
Ananas-Becher  
Gobelet ananas  
Vaso de piña

art.	Ø cm.	h. cm.	ml.	col.
44945G05	9,5	20,5	500	●
44945C05	9,5	20,5	500	●

With straw. – Con cannuccia.



SS

**Champagne glass**

Flute champagne  
Champagner Glas  
Verre champagne  
Copa champán

art.	Ø cm.	h. cm.	ml.	col.
41493G00	5	25,5	270	●
41493C00	5	25,5	270	●
41493B00	5	25,5	270	●



SS

**Martini cup**

Coppa martini  
Martini Cocktail Glas  
Verre à martini  
Copa martini

art.	Ø cm.	h. cm.	ml.	col.
41494G00	12	16,5	200	●
41494C00	12	16,5	200	●
41494B00	12	16,5	200	●



SS

**Margarita cup**

Coppa margarita  
Margarita Cocktail Glas  
Verre à margarita  
Copa margarita

art.	Ø cm.	h. cm.	ml.	col.
41498G00	10,5	14	220	●
41498C00	10,5	14	220	●
41498B00	10,5	14	220	●



SS

**Moscow mule mug**

Tazza moscow mule  
Moscow Mule Becher  
Gobelet moscow mule  
Taza moscow mule

art.	Ø cm.	h. cm.	ml.	col.
41463-01	8,9	9	500	●





SS

**Moscow mule mug**  
Tazza moscow mule  
Moscow Mule Becher  
Gobelet moscow mule  
Taza moscow mule

art.	Ø cm.	h. cm.	ml.	col.
41463-02	8,5	9,7	500	●

**Gold plated handle. – Manico dorato.**



SS

**Moscow mule mug, antique**  
Tazza moscow mule, antique  
Moscow Mule Becher, Antik  
Gobelet moscow mule, antique  
Taza moscow mule, antiguo

art.	Ø cm.	h. cm.	ml.	col.
41463A05	8,5	9,7	500	●

**Gold plated handle. – Manico dorato.**



SS

**Moscow mule mug**  
Tazza moscow mule  
Moscow Mule Becher  
Gobelet moscow mule  
Taza moscow mule

art.	Ø cm.	h. cm.	ml.	col.
41463G05	8,5	9,7	500	●

**Gold plated handle. – Manico dorato.**



SS

**Moscow mule mug**  
Tazza moscow mule  
Moscow Mule Becher  
Gobelet moscow mule  
Taza moscow mule

art.	Ø cm.	h. cm.	ml.	col.
41463B05	8,5	9,7	500	●

**Gold plated handle. – Manico dorato.**



SS

**Moscow mule mug**  
Tazza moscow mule  
Moscow Mule Becher  
Gobelet moscow mule  
Taza moscow mule

art.	Ø cm.	h. cm.	ml.
41463M05	8,5	10	550

**Water transfer printing. Gold plated handle.**  
Stampa a trasferimento ad acqua. Manico dorato.



SS

**Moscow mule mug**  
Tazza moscow mule  
Becher Moscow Mule  
Gobelet moscow mule  
Taza moscow mule

art.	Ø cm.	h. cm.	lt.	col.
41463C30	15,5	17,5	3	●
41463C50	18,0	20,0	5	●

**Gold plated handle. – Manico dorato.**



SS

**Moscow mule mug, antique**  
Tazza moscow mule, antique  
Becher Moscow Mule, Antik  
Gobelet moscow mule, antique  
Taza moscow mule, antiguo

art.	Ø cm.	h. cm.	lt.	col.
41463A30	15,5	17,5	3	●
41463A50	18,0	20,0	5	●

**Gold plated handle. – Manico dorato.**





SS

**Mini moscow mule mug**  
Mini moscow mule  
Moscow Mule Shotbecher  
Moscow mule à shot  
Chupito moscow mule

art.	Ø cm.	h. cm.	ml.	col.
41463C00	4,6	4,7	60	●

**Gold plated handle. Set 4 pcs. – Manico dorato. Conf. 4 pz.**



SS

**Mini moscow mule mug, antique**  
Mini moscow mule, antique  
Moscow Mule Shotbecher, Antik  
Moscow mule à shot, antique  
Chupito moscow mule, antiguo

art.	Ø cm.	h. cm.	ml.	col.
41463A00	4,6	4,7	60	●

**Gold plated handle. Set 4 pcs. – Manico dorato. Conf. 4 pz.**



SS

**Cola cup**  
Tazza Cola  
Cola-Becher  
Gobelet Cola  
Taza Cola

art.	Ø cm.	h. cm.	ml.	col.
44941G05	7,5	11	490	●
44941C05	7,5	11	490	●
44941B05	7,5	11	490	●



SS

**Mint julep cup**  
Coppa mint julep  
Becher für Mint Julep  
Tasse à cocktail mint julep  
Vaso para mint julep

art.	Ø cm.	h. cm.	ml.	col.
41497-05	8,5	10,5	380	●
41497G05	8,5	10,5	380	●
41497C05	8,5	10,5	380	●
41497B05	8,5	10,5	380	●





SS

**Julep mug**  
Tazza julep  
Becher Julep  
Gobelet julep  
Taza julep

art.	Ø cm.	h. cm.	ml.	col.
41470C03	8	12	335	●



SS

**Julep mug, antique**  
Tazza julep, antique  
Becher Julep, Antik  
Gobelet julep, antique  
Taza julep, antiguo

art.	Ø cm.	h. cm.	ml.	col.
41470A03	8	12	335	●



SS

**Mini mug**  
Mini tazza  
Shotbecher  
Verre à shot  
Vaso de chupito

art.	Ø cm.	h. cm.	ml.	col.
41470C00	4,5	5,5	60	●

Set 4 pcs. – Conf. 4 pz.



SS

**Mini mug, antique**  
Mini tazza, antique  
Shotbecher, Antik  
Verre à shot, antique  
Vaso de chupito, antiguo

art.	Ø cm.	h. cm.	ml.	col.
41470A00	4,5	5,5	60	●

Set 4 pcs. – Conf. 4 pz.



**Tiki skull glass**  
Tiki mug teschio in vetro  
Tiki-Schädelglas  
Tiki mug crâne en verre  
Vaso Tiki de vidrio

art.	Ø cm.	h. cm.	ml.
44948-07	13	10,5	700



**Tiki mug ceramic**  
Tiki mug in ceramica  
Tiki-Becher aus Keramik  
Tiki mug en céramique  
Taza Tiki en cerámica

art.	h. cm.	ml.
44949-02	22	500



**Tiki mug ceramic**

Tiki mug in ceramica  
Tiki-Becher aus Keramik  
Tiki mug en céramique  
Taza Tiki en cerámica

art.	Ø cm.	h. cm.	ml.
44949-01	9,3	11	450



**Tiki mug ceramic**

Tiki mug in ceramica  
Tiki-Becher aus Keramik  
Tiki mug en céramique  
Taza Tiki en cerámica

art.	Ø cm.	h. cm.	ml.
44949-03	7	21,5	650



**Tiki mug ceramic**

Tiki mug in ceramica  
Tiki-Becher aus Keramik  
Tiki mug en céramique  
Taza Tiki en cerámica

art.	h. cm.	ml.
44949-04	15	550



**Tiki mug ceramic**

Tiki mug in ceramica  
Tiki-Becher aus Keramik  
Tiki mug en céramique  
Taza Tiki en cerámica

art.	Ø cm.	h. cm.	ml.
44949-05	8	16,5	340



**Tiki mug ceramic**

Tiki mug in ceramica  
Tiki-Becher aus Keramik  
Tiki mug en céramique  
Taza Tiki en cerámica

art.	Ø cm.	h. cm.	ml.
44949-06	8	17	510



**PVD**

**SS**

**Straight straws**

Cannucce  
Strohhalme  
Pailles  
Pajitas

art.	Ø mm.	l. cm.	col.
41490-00	6	21,5	●
41490B00	6	21,5	●
41490G00	6	21,5	●
41490C00	6	21,5	●

**Set 12 pcs plus 1 straw brush.**

Conf. 12 pz + 1 scovolino.



**PVD**

**SS**

**Curved straws**

Cannucce curve  
Gebogene Strohhalme  
Pailles incurvées  
Pajitas curvados

art.	Ø mm.	l. cm.	col.
41490-01	6	21,5	●
41490B01	6	21,5	●
41490G01	6	21,5	●
41490C01	6	21,5	●

**Set 12 pcs plus 1 straw brush.**

Conf. 12 pz + 1 scovolino.



**SS**

**Straw brush, 5 pcs**

Scovolini, 5 pezzi  
Strohhalme-Bürste, 5 Stk.  
Brosses à pailles, 5 pièces  
Cepillos para pajitas, 5 pz

art.	l. cm.
41490-AA	21



B

**Straight straws, 24 pcs**

Cannucce, 24 pz  
Strohhalme, 24 Stk  
Pailles, 24 pièces  
Pajitas, 24 piezas

art.	Ø mm.	l.
48310-14	5-7	140
48310-20	5-7	200



B

**Straight straws, 150 pcs**

Cannucce, 150 pz  
Strohhalme, 150 Stk  
Pailles, 150 pièces  
Pajitas, 150 piezas

art.	Ø mm.	l.
48311-20	6-8	200
48311-25	6-8	250



B

**Straight straws, 110 pcs**

Cannucce, 110 pz  
Strohhalme, 110 Stk  
Pailles, 110 pièces  
Pajitas, 110 piezas

art.	Ø mm.	l.
48312-25	9-10	250



B

**Straight straws, 24 pcs**

Cannucce, 24 pz  
Strohhalme, 24 Stk  
Pailles, 24 pièces  
Pajitas, 24 piezas

art.	Ø mm.	l.
48313-14	10-12	140
48313-18	10-12	180
48313-20	10-12	200



**3 Straight straws, 3 bent, glass**

3 Cannucce diritte, 3 curve in vetro  
3 Gerade Strohhalme, 3 gebogene aus Glas  
3 Pailles droites, 3 incurvées en verre  
3 Pajitas eectas, 3 curvados de vidrio

art.	Ø mm.	l.
41495-08	8	215
41495-10	10	215

Incl. 2 straw brushes. – Incl. 2 scovolini.



SS

**Drinks stirrers flamingo, 4 pcs**

Miscelatori cocktail fenicottero, 4 pz  
Flamingo-Cocktail Rührer, 4 Stk  
Agitateurs cocktails flamant, 4 pcs  
Agitadores cócteles flamingo, 4 pz

art.	l. cm.	col.
41491G00	21,5	●
41491C00	21,5	●



SS

**Drinks stirrers skull, 4 pcs**

Miscelatori cocktail teschio, 4 pz  
Totenkopf-Cocktail Rührer, 4 Stk  
Agitateurs tête de mort, 4 pcs  
Agitadores cócteles cráneo, 4 pz

art.	l. cm.	col.
41491G01	18,5	●
41491C01	18,5	●



SS

**Drinks stirrers pineapple, 4 pcs**

Miscelatori cocktail ananas, 4 pz  
Ananas-Cocktail Rührer, 4 Stk  
Agitateurs cocktails ananas, 4 pcs  
Agitadores cócteles piña, 4 pz

art.	l. cm.	col.
41491G02	20	●
41491C02	20	●





SS

**Drinks stirrers owl, 4 pcs**

Miscelatori cocktail gufo, 4 pz  
Eule-Cocktail Rührer, 4 Stk  
Agitateurs cocktails hibou, 4 pcs  
Agitadores cócteles búho, 4 pz

art.	l. cm.	col.
41491G03	20	●
41491C03	20	●



SS

**Drinks stirrers seahorse, 4 pcs**

Miscelatori cavalluccio marino, 4 pz  
Seepferdchen-Cocktail Rührer, 4 Stk  
Agitateurs hippocampe, 4 pcs  
Agitadores caballo de mar, 4 pz

art.	l. cm.	col.
41491G04	20,5	●
41491C04	20,5	●



SS

**Drinks stirrers bow-knot, 4 pcs**

Miscelatori cocktail fiocco, 4 pz  
Bogenknoten-Cocktail Rührer, 4 Stk  
Agitateurs noeud d'arc, 4 pcs  
Agitadores nudo de proa, 4 pz

art.	l. cm.	col.
41491G05	21	●
41491C05	21	●



SS

**Drinks stirrers octopus, 4 pcs**

Miscelatori cocktail polipo, 4 pz  
Tintenfisch-Cocktail Rührer, 4 Stk  
Agitateurs cocktails poulpe, 4 pcs  
Agitadores cócteles pulpo, 4 pz

art.	l. cm.	col.
41491G06	18,5	●
41491C06	18,5	●



SS

**Tweezer**

Pinza  
Zange  
Pince  
Pinza

art.	l. cm.	col.
42902-30	30	●
42902G30	30	●



SS

**Tweezer**

Pinza  
Zange  
Pince  
Pinza

art.	l. cm.	col.
42902C30	30	●
42902B30	30	●



SS

**Tweezer**

Pinza  
Zange  
Pince  
Pinza

art.	l. cm.
42902-31	30



SS

**Cocktail spoon**

Cucchiaio miscelatore  
Cocktail-Löffel  
Cuillère à cocktail  
Cuchara cóctel

art.	l. cm.
41605-00	27



SS

**Cocktail spoon**

Cucchiaio miscelatore  
Cocktail-Löffel  
Cuillère à cocktail  
Cuchara cóctel

art.	l. cm.	col.
41605-01	28	●



SS

**Cocktail spoon**

Cucchiaio miscelatore  
Cocktail-Löffel  
Cuillère à cocktail  
Cuchara cóctel

art.	l. cm.	col.
41605G27	28	●
41605B27	28	●



SS

**Cocktail spoon/fork**

Cucchiaio/forchetta miscelatore  
Cocktail-Löffell/-Gabel  
Cuillère/fourchette à cocktail  
Cuchara/tenedor cóctel

art.	l. cm.	col.
41605-03	50	●
41605G03	50	●



SS

**Cocktail spoon/fork**

Cucchiaio/forchetta miscelatore  
Cocktail-Löffell/-Gabel  
Cuillère/fourchette à cocktail  
Cuchara/tenedor cóctel

art.	l. cm.	col.
41605C03	50	●
41605B03	50	●





SS

**Absinthe spoon**  
Cucchiaio assenzio  
Absinth-Löffel  
Cuillère d'absinthe  
Cuchara de ajenjo

art.	l. cm.	col.
41600-00	16	●
41600G00	16	●
41600C00	16	●



SS

**Magic spoon whisks**  
Cucchiaio magico  
Zauberlöffel  
Fouet plat à spirales  
Cuchara mágica

art.	l. cm.
41595-20	20



SS

**Strainer**  
Colino  
Sieb  
Passoire  
Colador

art.	Ø cm.	col.
41570-10	10	●
41570G10	10	●



SS

**Strainer**  
Colino  
Sieb  
Passoire  
Colador

art.	Ø cm.	col.
41570C10	10	●
41570B10	10	●



SS

**Cocktail strainer**  
Colino cocktail  
Cocktail-Sieb  
Passoire à cocktail  
Colador cóctel

art.	Ø cm.	col.
41603-00	9	●
41603G00	9	●



SS

**Cocktail strainer**  
Colino cocktail  
Cocktail-Sieb  
Passoire à cocktail  
Colador cóctel

art.	Ø cm.	col.
41603C00	9	●
41603B00	9	●



SS

**Julep strainer**  
Colino Julep  
Julep Barsieb  
Tamis cocktail Julep  
Colador de cóctel

art.	Ø cm.	col.
41603-07	7,5	●
41603G07	7,5	●



SS

**Julep strainer**  
Colino Julep  
Julep Barsieb  
Tamis cocktail Julep  
Colador de cóctel

art.	Ø cm.	col.
41603C07	7,5	●
41603B07	7,5	●



SS

**Cocktail measuring cup**  
Misurino cocktail  
Alkohol-Meßbecher  
Mesureur de cocktail  
Medidor de cóctel

art.	ml.
41609-75	75



SS

**Cocktail jigger**  
Misurino cocktail  
Cocktail-Doppelmaß  
Mesureur de cocktail  
Medidor de cóctel

art.	ml.	col.
41609-36	30/60	●
41609G36	30/60	●
41609C36	30/60	●
41609B36	30/60	●



SS

**Cocktail jigger**  
Misurino cocktail  
Cocktail-Doppelmaß  
Mesureur de cocktail  
Medidor de cóctel

art.	ml.	col.
41604-00	20/40	●
41604G00	20/40	●
41604C00	20/40	●
41604B00	20/40	●



**SS**

**Japanese jigger**  
Misurino cocktail Giapponese  
Japanischer Messbecher  
Mesureur de cocktail Japonais  
Medidor de cóctel Japonés

art. ml. col.

41604-01	20/40	●
41604G01	20/40	●
41604C01	20/40	●
41604B01	20/40	●



**SS**

**Long-drink shaker**  
Shaker  
Shaker  
Shaker  
Coctelera

art. Ø cm. h. cm. ml. col.

41484-05	8,8	20,5	500	●
41484G05	8,8	20,5	500	●
41484C05	8,8	20,5	500	●
41484B05	8,8	20,5	500	●



**SS**

**Long-drink shaker**  
Shaker  
Shaker  
Shaker  
Coctelera

art. ml.

41480-03	200
41480-05	500
41480-07	700



**SS**

**SAN**

**Long-drink shaker**  
Shaker  
Shaker  
Shaker  
Coctelera

art. ml. col.

41481-02	550	●
41481-03	550	●



**AY**

**Long-drink shaker**  
Shaker  
Shaker  
Shaker  
Coctelera

art. ml.

41483-04	420
41483-06	660



SS

**Long-drink shaker**

Shaker  
Shaker  
Shaker  
Coctelera

art.	Ø cm.	h. cm.	ml.	col.
41480G05	8,7	20,5	500	●
41480C05	8,7	20,5	500	●
41480B05	8,7	20,5	500	●



SS

**Shaker parisienne**

Shaker parisienne  
Shaker parisienne  
Shaker parisienne  
Coctelera parisienne

art.	Ø cm.	h. cm.	ml.	col.
41461-07	9	23	700	●
41461G07	9	23	700	●
41461C07	9	23	700	●
41461B07	9	23	700	●



SS

**Shaker calabrese**

Shaker calabrese  
Shaker Calabrese  
Shaker calabrese  
Coctelera calabrese

art.	Ø cm.	h. cm.	ml.	col.
41464-09	9,5	24,5	900	●
41464G09	9,5	24,5	900	●
41464C09	9,5	24,5	900	●
41464B09	9,5	24,5	900	●



SS

**Boston tin + half tin**

Shaker boston 2 pz  
Boston Shaker, 2 Stk  
Shaker boston, 2 pcs  
Coctelera boston, 2 pz

art.	Ø cm.	ml.	col.
41467G08	9	790/590	●
41467C08	9	790/590	●
41467B08	9	790/590	●



SS

**Boston shaker, vinyl coated**

Cono boston, rivestimento vinile  
Boston-Shaker, Vinyl Überzug  
Shaker boston, revêtement en vinyle  
Coctelera boston, revestimiento vinilo

art.	Ø cm.	h. cm.	ml.	col.
41479-11	9	18	830	●
41479-15	9	18	830	○



SS

**Boston shaker, vinyl coated**

Cono boston, rivestimento vinile  
Boston-Shaker, Vinyl Überzug  
Shaker boston, revêtement en vinyle  
Coctelera boston, revestimiento vinilo

art.	Ø cm.	h. cm.	ml.	col.
41479-12	9	18	830	●
41479-13	9	18	830	●
41479-14	9	18	830	●



SS

**Boston shaker**

Cono boston con fondello  
Boston-Shaker  
Shaker boston  
Coctelera boston

art.	Ø cm.	h. cm.	ml.
41479-05	9	17	500





**Mixing glass**

Bicchiere miscelatore  
Rührglas  
Verre mélangeur  
Vaso mezclador

art.	Ø cm.	h. cm.	ml.
41479-AA	8,5	15	500



**Mixing glass**

Bicchiere miscelatore  
Rührglas  
Verre mélangeur  
Vaso mezclador

art.	Ø cm.	h. cm.	ml.
41478-50	8,8	15	473
41478-35	8,3	13	355



**Mixing glass**

Bicchiere miscelatore  
Rührglas  
Verre mélangeur  
Vaso mezclador

art.	Ø cm.	h. cm.	ml.
41477-50	9	15	473

**With ounce markings. – Graduato in once.**



**Mixing glass with lip**

Bicchiere miscelatore con becco versatore  
Rührglas mit Lippe  
Verre mélangeur avec bec verseur  
Vaso mezclador vertedor con pico

art.	Ø cm.	h. cm.	lt.
41514-05	9	16,5	0,5



**Mixing glass with lip**

Bicchiere miscelatore con becco versatore  
Rührglas mit Lippe  
Verre mélangeur avec bec verseur  
Vaso mezclador vertedor con pico

art.	Ø cm.	h. cm.	lt.
41514-10	11,5	19	0,95



**Whiskey glass**

Bicchiere whiskey  
Whiskey Glas  
Verre à whiskey  
Vaso whiskey

art.	Ø cm.	h. cm.	ml.
44940-01	8,5	9,5	420

**U.Pack 6 pcs**

**PC**



**Juice glass**

Bicchiere succo  
Fruchtsaft-Glas  
Verre à jus  
Vaso zumo

art.	Ø cm.	h. cm.	ml.
44940-02	7,5	15,5	460

**U.Pack 6 pcs**

**PC**



**Beer glass**

Boccale birra  
Bier-Glas  
Verre à bière  
Vaso cerveza

art.	Ø cm.	h. cm.	ml.
44940-06	8	23	450

**U.Pack 6 pcs**

**PC**



**Beer glass**

Boccale birra  
Bier-Glas  
Verre à bière  
Vaso cerveza

art.	Ø cm.	h. cm.	ml.
44940-08	9	16	500

**U.Pack 6 pcs**

**SMMA**



**Margarita glass**

Bicchiere margarita  
Margarita-Glas  
Verre à margarita  
Vaso margarita

art.	Ø cm.	h. cm.	ml.
44940-10	12	18	300

**U.Pack 6 pcs**

**PC**







PC

**Martini glass**  
Bicchiere martini  
Martini-Glas  
Verre à martini  
Vaso martini

art.	Ø cm.	h. cm.	ml.
44940-11	12	17	240

U.Pack 6 pcs



PC

**Wine glass**  
Bicchiere vino  
Wein-Glas  
Verre à vin  
Vaso vino

art.	Ø cm.	h. cm.	ml.
44940-12	7	21	300

U.Pack 6 pcs



PC

**Wine glass**  
Bicchiere vino  
Wein-Glas  
Verre à vin  
Vaso vino

art.	Ø cm.	h. cm.	ml.
44940-13	7	19	200

U.Pack 6 pcs



PC

**Champagne glass**  
Bicchiere spumante  
Sekt-Glas  
Flûte  
Vaso champaña

art.	Ø cm.	h. cm.	ml.
44940-14	5	22	180

U.Pack 6 pcs



PC

**Mixing glass**  
Bicchiere  
Glas  
Verre  
Vaso

art.	Ø cm.	h. cm.	ml.
44940-16	9	16	540

U.Pack 6 pcs



PC

**Whiskey/rocks glass**  
Bicchiere whiskey/rocks  
Whiskey-/Rocks-Glas  
Verre à whiskey/rocks  
Vaso whiskey/rocks

art.	Ø cm.	h. cm.	ml.
44940-17	9	12	420

U.Pack 6 pcs



PC

**Whiskey/rocks glass**  
Bicchiere whiskey/rocks  
Whiskey-/Rocks-Glas  
Verre à whiskey/rocks  
Vaso whiskey/rocks

art.	Ø cm.	h. cm.	ml.
44940-18	8,5	11,5	420

U.Pack 6 pcs



PC

**Cooler**  
Bicchiere  
Glas  
Verre  
Vaso

art.	Ø cm.	h. cm.	ml.
44940-19	8	17	540

U.Pack 6 pcs



PC

**Tumbler**  
Bicchiere  
Trinkbecher  
Gobelet  
Vaso

art.	Ø cm.	h. cm.	ml.
44940-24	7,5	12,5	360
44940-25	8,0	13,5	480
44940-26	8,5	16,0	660

U.Pack 6 pcs





**PC**

**Tumbler**  
Bicchiere  
Trinkbecher  
Gobelet  
Vaso

art.	Ø cm.	h. cm.	ml.
44940-32	7,5	12,5	360
44940-33	8,0	13,5	480
44940-34	8,5	16,0	660

**U.Pack 6 pcs**



**SAN**

**Tumbler**  
Bicchiere  
Trinkbecher  
Gobelet  
Vaso

art.	Ø cm.	h. cm.	ml.
44990-15	5,5	9,5	150
44990-24	6,5	10,0	240
44990-29	7,0	11,0	290
44990-36	7,5	13,0	360
44990-48	8,0	15,0	480

**U.Pack 6 pcs**



**Cover with spout**  
Coperchio con beccuccio  
Deckel mit Ausguss  
Couverture avec bec  
Tapa con boquilla

art.	Ø cm.	U. Pack
44871-23	7	10

**TPE. For PC glasses 250 ml.**  
TPE. Per bicchieri in PC da 250 ml.



**PC**

**Water tumbler**  
Bicchiere acqua  
Wasserglas  
Verre à eau  
Vaso agua

art.	Ø cm.	h. cm.	ml.	U. Pack	col.
44871-20	7,0	7,0	170	50	○
44871-21	7,0	10,2	250	30	○
44871-22	7,8	11,4	350	30	○



**PC**

**Water tumbler**  
Bicchiere acqua  
Wasserglas  
Verre à eau  
Vaso agua

art.	Ø cm.	h. cm.	ml.	U. Pack	col.
44871R20	7,0	7,0	170	50	●
44871L20	7,0	7,0	170	50	●
44871G20	7,0	7,0	170	50	●
44871B20	7,0	7,0	170	50	●



**PC**

**Water tumbler**  
Bicchiere acqua  
Wasserglas  
Verre à eau  
Vaso agua

art.	Ø cm.	h. cm.	ml.	U. Pack	col.
44871R21	7,0	10,2	250	30	●
44871L21	7,0	10,2	250	30	●
44871G21	7,0	10,2	250	30	●
44871B21	7,0	10,2	250	30	●



**PC**

**Water jug**  
Caraffa  
Wasserkrug  
Crûche à eau  
Jarra agua

art.	dim. cm.	l.
44871-28	12x13,8	0,5
44871-30	17,4x17	1,0
44871-32	18,7x19,8	1,5
44871-34	21,6x18,8	2,0

**Withstands temperatures/Termoresistenti da: -30° +120°C.**



PP

Lid  
Coperchio  
Deckel  
Couvercle  
Tapa

art.	dim. cm.	fits/per	U. Pack
44871-29	9,9x1,4	l. 0,5	10
44871-31	11,2x1,9	l. 1,0	10
44871-33	14x2,4	l. 1,5	10
44871-35	15,9x2,2	l. 2,0	10

Withstands temperatures/Termoresistenti  
da: -40° +100°C.



SMMA

Cocktail glass  
Bicchiere cocktail  
Cocktail Glas  
Verre à cocktail  
Vaso cocktail

art.	Ø cm.	h. cm.	ml.
44942-01	8	21	350

U.Pack 6 pcs



SMMA

Cocktail glass  
Bicchiere cocktail  
Cocktail Glas  
Verre à cocktail  
Vaso cocktail

art.	Ø cm.	h. cm.	ml.
44942-02	11	21	460

U.Pack 6 pcs



SMMA

Martini glass  
Bicchiere martini  
Martini-Glas  
Verre à martini  
Vaso martini

art.	Ø cm.	h. cm.	ml.
44942-03	10,5	20	340

U.Pack 6 pcs



SMMA

Cocktail glass  
Bicchiere cocktail  
Cocktail Glas  
Verre à cocktail  
Vaso cocktail

art.	Ø cm.	h. cm.	ml.
44942-04	7,5	23	220

U.Pack 6 pcs



SMMA

Margarita glass  
Bicchiere margarita  
Margarita-Glas  
Verre à margarita  
Vaso margarita

art.	Ø cm.	h. cm.	ml.
44942-05	12	17,5	340

U.Pack 6 pcs



SS

Fruit basket  
Cesto agrumi  
Obstkorb  
Panier à fruits  
Cesta frutas

art.	Ø cm.	h. cm.
41611-20	21,5	20





SS

**Fruit basket, oval**  
Cesto frutta, ovale  
Obstschale, oval  
Panier à fruits, ovale  
Cesta fruta, oval

art.	dim. cm.
42956-19	19x15
42956-24	24,5x18
42956-28	28x21



NEW

**Serving stand 2-tier**  
Alzata 2 piani  
Serviergestell, 2-stufig  
Présentoir 2 étages  
Soporte 2 niveles

art.	dim. cm.
41208-06	31x17x38

**Black metal frame with non-slip feet, 2 baskets 29x16x7 cm, 2 acacia wood boards 28,5x15,5x1,5 cm.** – Struttura in metallo nero con piedini antiscivolo, 2 cesti cm 29x16x7, 2 assi in legno di acacia cm 28,5x15,5x1,5.



NEW

**Fruit basket 2-tier**  
Cesto agrumi 2 piani  
Obstkorb, 2-stufig  
Panier à fruits 2 étages  
Cesta frutas 2 niveles

art.	Ø cm.	h. cm.
41208-02	22/26	48

**Wooden handle, metal black baskets Ø 22 H 6 cm and Ø 26 H 8 cm.** – Manico legno, cesti in metallo nero Ø 22 H 6 cm e Ø 26 H 8 cm.



**Orange juicer, chromed**  
Spremiagrumi manuale, cromato  
Orangenpresse, verchromt  
Presse-agrumes, chromé  
Exprimidor de cítricos, cromado

art.	dim. cm.
41456-02	18x13x46



SS

**Lemon squeezer**  
Spremilimone  
Zitronenpresse  
Presse citron  
Exprime limones

art.	dim. cm.
41606-00	12,5x6,5



SS

**Lemon squeezer**  
Spremilimone  
Zitronenpresse  
Presse citron  
Exprime limones

art.	dim. cm.
41606-01	7x8,5



**Lemon squeezer, aluminum**  
Spremilimone, alluminio  
Zitronenpresse, aluminum  
Presse citron, alu  
Exprime limones, aluminio

art.	l. cm.
41606-02	20



**Lemon/lime squeezer, aluminum**  
Spremilimone/lime, alluminio  
Zitronen-/Limettenpresse, aluminum  
Presse citron, alu  
Exprimidor de limón/lima, aluminio

art.	dim. cm.
41606-22	22x7,5

**3 pieces, powder coated yellow and green.**  
3 pezzi, verniciati a polvere giallo e verde.







**Soda siphon**

Sifone soda  
Soda Siphon  
Siphon à eau de seltz  
Sifón agua de seltz

art.	lt.
41453-11	1



**Soda siphon**

Sifone soda  
Soda Siphon  
Siphon à eau de seltz  
Sifón agua de seltz

art.	lt.
41465-10	1



**Soda siphon**

Sifone soda  
Soda Siphon  
Siphon à eau de seltz  
Sifón agua de seltz

art.	lt.
41454-01	1



**2 Bottles Twist&Sparkle**

2 Bottiglie Twist&Sparkle  
2 Flaschen Twist&Sparkle  
2 Bouteilles Twist&Sparkle  
2 Botellas Twist&Sparkle

art.	lt.
41454-99	1



**Soda chargers, 10-pcs set**

Ricariche soda, 10 pezzi  
10-Stk. Sodakapseln-Packung  
Capsules à eau de seltz, set 10 pcs  
Cápsulas para agua de seltz, 10 pz

art.
41453-AA

**Content: 8 g of CO2. – Contenuto: 8 gr di CO2.**



**Ice pick**

Rompighiaccio  
Eisstößel  
Casse-glace  
Pico para hielo

art.	l. cm.
44105-00	23

**Wooden handle. – Manico legno.**



**Muddler, plastic**

Pestaghiaccio, plastica  
Eiszerstosser, Kunststoff  
Pic à glace, plastique  
Pico para hielo, plástico

art.	l. cm.
41503-22	22,5



SS

**Muddler**

Pestaghiaccio  
Eiszerstosser  
Pic à glace  
Pico para hielo

art.	l. cm.
41503-21	20



**Ice crusher, chromed**

Tritaghiaccio, cromato  
Eiswolf, verchromt  
Broyer à glace, chromé  
Trituradora de hielo, cromada

art.	dim. cm.
41457-00	15x12x26



SS

**Ice scoop**

Sessola per ghiaccio  
Eisschaufel  
Pelle à glace  
Librador para hielo

art.	ml.
41503-00	100



PC

**Ice scoop**

Sessola per ghiaccio  
Eisschaufel  
Pelle à glace  
Librador para hielo

art.	ml.
14958-01	100
14958-02	250



SS

**Ice spoon**

Cucchiaio ghiaccio  
Eislöffel  
Cuillère à glace  
Cuchara hielo

art.	l. cm.
12550-04	22





**Mold for ice-balls**

Stampo sfere di ghiaccio  
Eis-Kugel-Former  
Moule pour boules de glace  
Molde bolas de hielo

art. dim. cm.  
41515-03 24x8,5

**For 3 balls ø 5,5 cm, 100 ml.**  
Per 3 sfere ø 5,5 cm da 100 ml.



**Mold for ice-ball, silicone**

Stampo sfera di ghiaccio, silicone  
Eis-Kugel-Former, Silikon  
Moule à boule de glace, silicone  
Molde bola de hielo, silicona

art. dim. cm.  
41515-10 6,8x7,5

**For 1 ball ø 6 cm. – Per 1 sfera ø 6 cm.**



**Mold for ice-balls, silicone**

Stampo sfere di ghiaccio, silicone  
Eis-Kugel-Former, Silikon  
Moule à boules de glace, silicone  
Molde bolas de hielo, silicona

art. dim. cm.  
41515-08 12x12x5

**For 4 balls ø 4,5 cm. – Per 4 sfere ø 4,5 cm.**



**Mold for ice-balls, silicone**

Stampo sfere di ghiaccio, silicone  
Eis-Kugel-Former, Silikon  
Moule à boules de glace, silicone  
Molde bolas de hielo, silicona

art. dim. cm.  
41515-09 23,5x12,8x5

**For 8 balls ø 4 cm. – Per 8 sfere ø 4 cm.**



**Mold for ice-skulls, silicone**

Stampo teschi ghiaccio, silicone  
Eis-Schädel-Former, Silikon  
Moule à crânes de glace, silicone  
Molde de crâneos de hielo, silicona

art. dim. cm.  
41515-05 11x8



**Mold for ice-cubes, silicone**

Stampo cubetti ghiaccio, silicone  
Eiswürfel-Former, Silikon  
Moule à glaçons, silicone  
Molde cubitos de hielo, silicona

art. dim. cm.  
41515-20 27x14x3,5

**For 21 cubes 3 cm. – Per 21 cubetti 3 cm.**



**Mold for ice-cubes, silicone**

Stampo cubetti ghiaccio, silicone  
Eiswürfel-Former, Silikon  
Moule à glaçons, silicone  
Molde cubitos de hielo, silicona

art. dim. cm.  
41515-21 25x12x3

**For 32 cubes 2,5 cm. – Per 32 cubetti 2,5 cm.**



**Mold for ice-diamonds, silicone**

Stampo diamanti ghiaccio, silicone  
Eis-Diamant-Former, Silikon  
Moule à diamants de glace, silicone  
Molde de diamante de hielo, silicona

art. dim. cm.  
41515-07 12x12

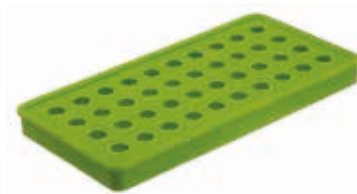

**Mold for ice-balls, silicone**

Stampo sfere di ghiaccio, silicone  
Eis-Kugel-Former, Silikon  
Moule à boules de glace, silicone  
Molde bolas de hielo, silicona

art. dim. cm.  
41515-22 24x13x2

**For 40 balls ø 1 cm. – Per 40 sfere ø 1 cm.**





SS

**Ice tongs**

Molla ghiaccio  
Eiszange  
Pinces à glace  
Pinza hielo

art.	l. cm.	col.
41518G12	16	●
41518C12	16	●
41518B12	16	●



**Ice bucket with tongs**

Secchio ghiaccio e pinza  
Eiseimer mit Eiszange  
Seau à glace avec pince  
Cubo hielo con pinza

art.	Ø mm.	h. cm.	lt.
41513-13	14	22	1,3

**Noble plastic jacket highly chrome plated with special insulated plastic insert.**

Camicia in materiale plastico, finitura cromata lucida con speciale inserto termico.



**Ice bucket, plastic**

Secchio ghiaccio, plastica  
Eiseimer, Kunststoff  
Seau à glace, plastique  
Cubo hielo, plástico

art.	Ø mm.	h. cm.	lt.
41512-15	15	15	1,5
41512-30	20	18	3,0

**Satin metal look with highly polished edge.**

**Special insulated plastic insert.**

Finitura effetto metallo satinato, bordo lucido. Speciale inserto termico.



PP

SAN

**Ice box**

Secchio ghiaccio  
Eisbox  
Seau à glace  
Cubitera

art.	dim. cm.	lt.
41512-50	27x27x15	5,4

**With drainer. – Con griglia.**



SS

**Ice bucket**

Secchio ghiaccio  
Eisbehälter  
Seau à glace  
Cubitera hielo

art.	Ø cm.	h. cm.
46116-15	12,5	13



SS

**Ice bucket**

Secchio ghiaccio  
Eisbehälter  
Seau à glace  
Cubitera hielo

art.	Ø cm.	h. cm.	lt.	col.
41513G20	15	14	2	●
41513C20	15	14	2	●
41513B20	15	14	2	●



**Bar organizer**

Porta oggetti da bar  
Bar-Behälter  
Présentoir de bar  
Dispensador bar

art.	dim. cm.
44102-24	24x14,5x11



**Flair bottle**

Flair bottle  
Flair bottle  
Flair bottle  
Flair bottle

art.	lt.	col.
44108-01	0,75	○
44108-02	0,75	●



ABS

**Smoking gun**

Affumicatore  
Räuchergerät  
Pistolet à fumer  
Ahumador aromatizador

art.	dim. cm.
49923-00	16,2x5,5x12,5

**DC6V - 3,0L/min. Ideal for flavoring and smoking liquid and solid products, such as: cocktails, vegetables, meat and fish. – Ideale per aromatizzare e affumicare prodotti liquidi e solidi, come: cocktail, verdure, carne e pesce.**



**NEW**

**Smoking chips**

Segatura aromatizzata  
Aromatisiertes Sägemehl  
Sciure aromatisée  
Serrín aromatizado

art. ml.  
49923-99 4x250

**Mesquite/Hickory/Oak/Cherry.**  
Mesquite/Hickory/Rovere/Ciliegio.



**Cocktail cover**

Cloche per affumicatore  
Cocktail Räucherglocke  
Cloche à fumée  
Campana para ahumado

art. Ø cm. h. cm.  
49923-01 12 11  
49923-02 12 16

**Glass cover, wood base ø 15 cm.**  
Cloche vetro, base legno ø 15 cm.



**NEW**

**PC**

**Cocktail cover**

Cloche per affumicatore  
Cocktail Räucherglocke  
Cloche à fumée  
Campana para ahumado

art. Ø cm. h. cm.  
49924-21 21 17  
49924-31 30 22  
49924-36 36 27



**Skull dash bottle**

Bottiglia angostura teschio  
Schädel Dash Bottle  
Dash bottle crâne  
Dash bottle cráneo

art. ml.  
41680-03 30  
41680-06 60  
41680-12 120



**Atomizer dash bottle**

Bottiglia angostura spray  
Bitter Flasche Atomizer  
Vaporisateur d'angostura  
Botella angostrura spray

art. ml.  
41681-10 100





**Atomizer dash bottle**  
Bottiglia angostura spray  
Bitter Flasche Atomizer  
Vaporisateur d'angostura  
Botella angostrura spray

art.	h. cm.	ml.
41681-11	15	50



**Atomizer dash bottle**  
Bottiglia angostura spray  
Bitter Flasche Atomizer  
Vaporisateur d'angostura  
Botella angostrura spray

art.	Ø cm.	h. cm.	ml.	col.
41681-12	7	10	100	●



**Dash bottle**  
Bottiglia angostura  
Bitter Flasche  
Dash bottle  
Botella angostrura

art.	ml.
41681-06	150



**Dash Bottle**  
Bottiglia angostura  
Bitter Flasche  
Dash Bottle  
Botella Angostrura

art.	dim. cm.	ml.
41681-01	6,5x6,5x10	100



**Dash Bottle**  
Bottiglia angostura  
Bitter Flasche  
Dash Bottle  
Botella Angostrura

art.	Ø cm.	h. cm.	ml.
41681-03	8,5	15	280



**Dash Bottle**  
Bottiglia angostura  
Bitter Flasche  
Dash Bottle  
Botella Angostrura

art.	dim. cm.	ml.
41681-02	6x5x15	200

Without pourer. – Senza dosatore.



**Dash Bottle**  
Bottiglia angostura  
Bitter Flasche  
Dash Bottle  
Botella Angostrura

art.	Ø cm.	h. cm.	ml.
41681-04	6,2	10	100

Without pourer. – Senza dosatore.



**Bottle pourer**  
Tappo versatore  
Ausgiesser  
Bouchon verseur  
Tapón vertedor

art.
41681-99



PE

**Store & pour container**  
Contentitore versatore  
Dosier-Vorratsbehälter, komplett  
Bouteille verseuse  
Recipiente vertedor

art.	Ø cm.	h. cm.	lt.	col.
44106W05	9,0	26	0,5	○
44106W10	9,0	33	1,0	○
44106W20	12,5	35	2,0	○
44106W25	12,5	39	2,5	○



PE

**Store & pour container**  
Contentitore versatore  
Dosier-Vorratsbehälter, komplett  
Bouteille verseuse  
Recipiente vertedor

art.	Ø cm.	h. cm.	lt.	col.
44106G05	9,0	26	0,5	●
44106G10	9,0	33	1,0	●
44106G20	12,5	35	2,0	●
44106G25	12,5	39	2,5	●



PE

**Store & pour container**  
Contentitore versatore  
Dosier-Vorratsbehälter, komplett  
Bouteille verseuse  
Recipiente vertedor

art.	Ø cm.	h. cm.	lt.	col.
44106Y05	9,0	26	0,5	●
44106Y10	9,0	33	1,0	●
44106Y20	12,5	35	2,0	●
44106Y25	12,5	39	2,5	●



PE

**Store & pour container**

Contentitore versatore  
Dosier-Vorratsbehälter, komplett  
Bouteille verseuse  
Recipiente vertedor

art.	Ø cm.	h. cm.	lt.	col.
44106R05	9,0	26	0,5	●
44106R10	9,0	33	1,0	●
44106R20	12,5	35	2,0	●
44106R25	12,5	39	2,5	●



PE

**Store & pour container**

Contentitore versatore  
Dosier-Vorratsbehälter, komplett  
Bouteille verseuse  
Recipiente vertedor

art.	Ø cm.	h. cm.	lt.	col.
44106O05	9,0	26	0,5	●
44106O10	9,0	33	1,0	●
44106O20	12,5	35	2,0	●
44106O25	12,5	39	2,5	●



PE

**Store & pour container**

Contentitore versatore  
Dosier-Vorratsbehälter, komplett  
Bouteille verseuse  
Recipiente vertedor

art.	Ø cm.	h. cm.	lt.	col.
44106B05	9,0	26	0,5	●
44106B10	9,0	33	1,0	●
44106B20	12,5	35	2,0	●
44106B25	12,5	39	2,5	●



PE

**Storage canister**

Contentitore di riserva  
Vorratsbehälter  
Réipient réserve  
Recipiente reserva

art.	Ø cm.	h. cm.	lt.	col.
44107W05	9,0	9,5	0,5	○
44107W10	9,0	16	1,0	○
44107W20	12,5	20	2,0	○
44107W25	12,5	23	2,5	○



PE

**Storage canister**

Contentitore di riserva  
Vorratsbehälter  
Réipient réserve  
Recipiente reserva

art.	Ø cm.	h. cm.	lt.	col.
44107G05	9,0	9,5	0,5	●
44107G10	9,0	16	1,0	●
44107G20	12,5	20	2,0	●
44107G25	12,5	23	2,5	●



PE

**Storage canister**

Contentitore di riserva  
Vorratsbehälter  
Réipient réserve  
Recipiente reserva

art.	Ø cm.	h. cm.	lt.	col.
44107Y05	9,0	9,5	0,5	●
44107Y10	9,0	16	1,0	●
44107Y20	12,5	20	2,0	●
44107Y25	12,5	23	2,5	●



PE

**Storage canister**

Contentitore di riserva  
Vorratsbehälter  
Réipient réserve  
Recipiente reserva

art.	Ø cm.	h. cm.	lt.	col.
44107R05	9,0	9,5	0,5	●
44107R10	9,0	16	1,0	●
44107R20	12,5	20	2,0	●
44107R25	12,5	23	2,5	●



PE

**Storage canister**

Contentitore di riserva  
Vorratsbehälter  
Réipient réserve  
Recipiente reserva

art.	Ø cm.	h. cm.	lt.	col.
44107O05	9,0	9,5	0,5	●
44107O10	9,0	16	1,0	●
44107O20	12,5	20	2,0	●
44107O25	12,5	23	2,5	●



PE

**Storage canister**

Contentitore di riserva  
Vorratsbehälter  
Réipient réserve  
Recipiente reserva

art.	Ø cm.	h. cm.	lt.	col.
44107B05	9,0	9,5	0,5	●
44107B10	9,0	16	1,0	●
44107B20	12,5	20	2,0	●
44107B25	12,5	23	2,5	●



PS

**Pouring container cap**

Tappo per versatore  
Dosier-Behälterstopfen  
Bouchon à bouteille verseuse  
Tapón para recipiente vertedor

art.	pcs/pz
44106-12	12



PS

PP

**Condiment holder**

Portacondimenti  
Bar-Beilagenbehälter  
Boîte à condiments  
Caja condimentos

art.	dim. cm.	comp.
44103-03	49x15x9	3
44103-04	49x15x9	4
44103-06	49x15x9	6



SS

**Condiment holder**

Portacondimenti  
Bar-Beilagenbehälter  
Boîte à condiments  
Caja condimentos

art.	dim. cm.	comp.
41782-04	32x16x10	4
41782-05	39x16x10	5
41782-06	47x16x10	6



**Glass rimmer**

Bordatore bicchieri  
Bar-Kombination Salz-/Zuckerumranden  
Système de givrage de verres  
Ribeteador de vasos

art.	Ø cm.
44101-03	15,5



PE

**Bar liner**

Tappeto sottobicchieri  
Gläsermatte  
Revêtement de bar  
Tapete para vasos

art.	dim. cm.
44099-03	60x1300

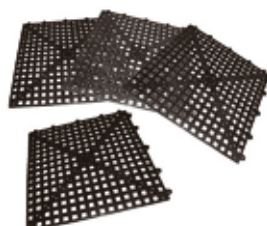

**Bar mat, non-slip**

Tappeto antiscivolo componibile  
Gläserabstellmatte, rutschfest  
Tapis antidérapant, composable  
Alfombra antiderrapante, componible

art.	dim. cm.
44100-04	30x30



**Bar runner**

Tappetino bar  
Gläserabstellmatte  
Tapis à verres  
Tapete para vasos

art.	dim. cm.
44100-01	68x8
44100-02	45x30





**Barman's set, 20 pcs**

Valigia Barman, 20 pz  
Barman-Koffer, 20 Stk.  
Mallette de barman, 20 pièces  
Alfombra, 20 piezas

art.  
14480-20

**Incl. –** Comprende: 41479-05 boston shaker, 41480-05 shaker, 41503-22 pestello/ice beater, 41595-20 cucchiaino magico/magic spoon, 41603-00 colino/strainer, 41604-00 misurino/measuring cup, 41605-00 miscelatore/mixing spoon, 41606-00 & 41606-01 spremilimone/lemon squeezer, 41606-02 spremi lime/lime squeezer, 41608-04 tappo/champagne stopper, 41699-06 cavatappi/corkscrew, 44058-10 tappo dosatore/dispenser plug 10ml, 48280-02 levacapsule/bottle opener, 48280-97 coltello barman/barman knife, 48280-92 rigalimoni/lemon striper, 48280-96 pelarance/orange peeler, 12550-04 cucchiaino ghiaccio/ice spoon, 12550-36 cucchiaino bibita/cocktail spoon, 12550-55 molla ghiaccio/ice tong.



**Barman apron**  
Grembiule barman  
Barman Schurz  
Tablier barman  
Mandil barman

art. dim. cm.  
48543-01 70x40

**65% polyester/poliestere. – 35% cotton/cotone. 195 g/mq.**



**Barman apron**  
Grembiule barman  
Barman Schurz  
Tablier barman  
Mandil barman

art. dim. cm.  
48543-02 70x40

**65% polyester/poliestere. – 35% cotton/cotone. 195 g/mq.**





SS

**Speed rack**  
Rastrelliera  
Flaschenregal  
Rack à bouteilles  
Estantería bar para botellas

art.	dim. cm.	bot.
44060-50	56x10,5x15,5	6
44060-80	81x10,5x15,5	8
44060-99	107x10,5x15,5	10



SS

**Speed rack**  
Rastrelliera  
Flaschenregal  
Rack à bouteilles  
Estantería bar para botellas

art.	dim. cm.	bot.
44060-51	56x21x15,5	2x 6



SS

**Glass shelf rack**  
Rastrelliera, fissaggio sospeso  
Gläserhalter Regalmontage  
Rack à verres fixation suspendue  
Rack de copas, fijación techo

art.	dim. cm.
44060-01	45x31,6x5,5



SS

**Glass wall rack**  
Rastrelliera, fissaggio murale  
Gläserhalter Wandmontage  
Rack à verres fixation murale  
Rack de copas, fijación mural

art.	dim. cm.
44060-02	45x31,6x5,6



SS

**Glass cleaning brush**  
Lavabicchieri  
Gläserpüler  
Brosse lave-verres  
Cepillo lavavasos

art.	dim. cm.
44135-02	38x18x29



**Glass cleaning brush, nylon**  
Spazzole lavabicchieri, nylon  
Bierglasbürstenständer, nylon  
Brosse lave-verres, nylon  
Cepillo lavavasos, nilón

art.	h. cm.
44130-02	16,5
44130-03	21,5



**Glass cleaning brush, nylon-aluminum**  
Spazzola lavabicchieri, nylon-alluminio  
Bierglasbürstenständer, Nylon-Aluminium  
Brosse lave-verres, nylon-alu  
Cepillo lavavasos, nilón-aluminio

art.	Ø cm.	h. cm.
44130-01	15	19



**Aluminum wall mounter bottle rack**  
Supporto a parete, alluminio  
Alu-Wandständer  
Support pour bouteilles en aluminium  
Soporte mural, aluminio

art.	l. cm.	bot.
44056-04	41	4
44056-06	67	6

Dispensers not included. – Dosatori non inclusi.



**Revolving bottle rack**  
Supporto rotante da banco  
Theken-Drehständer vollständig  
Support rotatif de comptoir  
Soporte giratorio

art.	h. cm.	bot.
44057-04	70	4
44057-06	70	6

Dispensers not included. – Dosatori non inclusi.





**Standard aluminum support**

Supporto bottiglia, alluminio  
Alu-Standard Ständer,  
Support en aluminium  
Soporte de botella, aluminio

art.	col.
44056-01	●
44056-11	●
44056-21	●

**Universal fitting, shelf or wall mounting.**

Fissaggio universale, a ripiano o parete.



**Chrome plated dispenser**

Dosatore cromato  
Verchromter Dosierer  
Doseur chromé  
Dosificador cromado

art.	ml.
44055-10	10
44055-50	50



**Chrome plated dispenser**

Dosatore cromato  
Verchromter Dosierer  
Doseur chromé  
Dosificador cromado

art.	ml.
44055-20	20
44055-25	25
44055-30	30
44055-35	35
44055-40	40



**Dispenser**

Dosatore  
Dosierer  
Doseur  
Dosificador

art.	ml.	col.
44055G30	30	●
44055G40	40	●
44055C30	30	●
44055C40	40	●



**Automatic dispenser plug**

Tappo dosatore automatico  
Automatischer Portionierer  
Bouchon doseur automatique  
Bola dosificadora

art.	ml.
44058-20	20
44058-25	25
44058-30	30



**Automatic dispenser plug**

Tappo dosatore automatico  
Automatischer Portionierer  
Bouchon doseur automatique  
Bola dosificadora

art.	ml.
44058-10	10
44058-40	40
44058-50	50



**Bottle pourer with stopper**

Tappo versatore con chiusura  
Ausgießer mit Kappe  
Bouchon avec clapet  
Tapón vertedor con cierre

art.	pcs/pz
44111-02	2

SS



**Free flow pourer**

Tappo versatore continuo  
Permanentausgießer  
Bouchon verseur continu  
Vertedor continuo

art.	pcs/pz	col.
44110-01	12	●
44110-02	12	●
44110-03	12	●



**Free flow pourer**

Tappo versatore continuo  
Permanentausgießer  
Bouchon verseur continu  
Vertedor continuo

art.	pcs/pz	col.
44110-04	12	●
44110-05	12	○
44110-06	12	●



**Free flow pourer**

Tappo versatore continuo  
Permanentausgiesser  
Bouchon verseur continu  
Vertedor continuo

art.	pcs/pz
44110-00	12



**Measuring pourer**

Tappo versatore dosatore  
Dosierausgiesser  
Bouchon verseur doseur  
Tapón vertedor dosificador

art.	U. Pack	col.
44119-01	6	●
44119-02	6	●
44119-03	6	●
44119-04	6	●
44119-06	6	●



**Measuring pourer**

Tappo versatore dosatore  
Dosierausgiesser  
Bouchon verseur doseur  
Tapón vertedor dosificador

art.
44114-01
44114-02
44114-03

SS



**Measured pourer**

Tappo metrico  
Portioniererausgiesser  
Bouchon doseur  
Caños dosificador

art.	ml.	U. Pack	col.
44118-10	10	6	●
44118-20	20	6	●
44118-25	25	6	●
44118-30	30	6	●



**Measured pourer**

Tappo metrico  
Portioniererausgiesser  
Bouchon doseur  
Caños dosificador

art.	ml.	U. Pack	col.
44118-35	35	6	●
44118-40	40	6	●
44118-50	50	6	○



**Whiskey pourer**

Tappo versatore  
Ausgiesser  
Bouchon verseur  
Vertedor

art.	pcs/pz	col.
44112-01	12	●
44112-02	12	○



**Champagne stopper**

Tappo spumante  
Sektflaschenstopfen  
Bouchon à champagne  
Tapón Champaña

art.
41608-20



**Champagne stopper**

Tappo spumante  
Sektflaschenstopfen  
Bouchon à champagne  
Tapón Champaña

art.
41608-04

SS



**Champagne stopper**

Tappo spumante  
Sektflaschenstopfen  
Bouchon à champagne  
Tapón Champaña

art.
41608-08

SS



**Champagne stopper**

Tappo spumante  
Sektflaschenstopfen  
Bouchon à champagne  
Tapón Champaña

art.
41608-00

SS



**Champagne stopper**

Tappo spumante  
Sektflaschenstopfen  
Bouchon à champagne  
Tapón Champaña

art.
46796-00

SS



**Wine stopper**

Tappo vino  
Weinflaschenstopfen  
Bouchon à vin  
Tapón vino

art.
41608-03

SS





SS  
ABS

**Vacuum pump wine preserver + 2 stoppers**

Pompa sottovuoto per vino + 2 tappi  
Wein-Vakuum-Pumpe + 2 Stopfen  
Pompe à vide d'air + 2 bouchons  
Bomba vacío vino + 2 tapones

art.  
41500-00



**Set 2 stoppers**

Set 2 tappi  
Satz 2 Stopfen  
Jeu 2 bouchons  
Juego 2 tapones

art.  
41500-AA



**Foil cutter**

Taglia capsula  
Folienchneider  
Coupe-capsules  
Cortacápsulas

art.  
49858-07



**Winged corkscrew**

Cavatappi a doppia leva  
Korkenzieher mit Doppelhebel  
Tire-bouchon à double levier  
Sacacorchos a doble palanca

art.  
41699-10



**Waiter's corkscrew**

Cavatappi cameriere  
Kellner Korkenzieher  
Tire-bouchon sommelier  
Sacacorchos camarero

art.  
41699-20



**Waiter's corkscrew**

Cavatappi cameriere  
Kellner Korkenzieher  
Tire-bouchon sommelier  
Sacacorchos camarero

art.  
41699-06



**Lever corkscrew**

Cavatappi a leva  
Korkenzieher  
Tire-bouchon  
Sacacorchos

art.  
49858-01



**Lever corkscrew**

Cavatappi a leva  
Korkenzieher  
Tire-bouchon  
Sacacorchos

art.  
49858-00





**Waiter's corkscrew case**

Valigetta cameriere  
Kellner Korkenzieher-Koffer  
Mallette tire-bouchon sommelier  
Maletín sacacorchos sumiller

art. 49858-06



**Bottle opener with collector box**

Levacapsule con contenitore di raccolta  
Flaschenöffner mit Sammelbehälter  
Décapsuleur avec récipient de récupération  
Abridor de botellas + caja de recuperación

art. 48223-00 dim. cm. 12x7x30



SS

**Bottle opener**

Levacapsule  
Flaschenöffner  
Décapsuleur  
Abrebotellas

art.	dim. cm.	col.
41699-18	18x4	●
41699G18	18x4	●
41699C18	18x4	●
41699B18	18x4	●



SS

**Bottle opener**

Levacapsule  
Flaschenöffner  
Décapsuleur  
Abrebotellas

art. 41699-12 dim. cm. 11x4



SS

**Bottle opener**

Levacapsule  
Flaschenöffner  
Décapsuleur  
Abrebotellas

art. 41699-04 dim. cm. 11x4



**Bar blade holster with belt clip**

Fondina per levacapsule  
Flaschenöffner-Halter  
Etui pour décapsuleur  
Funda para abrebotellas

art. 41699-13 dim. cm. 11x4



**Bottle opener, nickelplated**

Levacapsule nichelato  
Flaschenöffner, vernickelt  
Décapsuleur, nickelé  
Abrebotellas, niquelado

art. 41699-03



SS

E<sup>o</sup>dlund

**Can punch and bottle opener**

Apriscatole/levacapsule  
Dosen-/Flaschenöffner  
Ouvre-boîte/décapsuleur  
Abrelatas/botellas

art. 49860-00



B

**Tepokushi skewers**

Spiedini tepokushi  
Tepokushi Spieß  
Brochettes tepokushi  
Pinchos tepokushi

art.	l. cm.	pcs/pz
48300-43	9	100
48300-33	15	100



B

**Noshikushi skewers**

Spiedini noshikushi  
Noshikushi Spieß  
Brochettes noshikushi  
Pinchos noshikushi

art. 48300-42 l. cm. 10,5 pcs/pz 100





**W**

**Toothpicks**  
Stuzzicadenti  
Zahnstocher  
Cure-dents  
Palillos

art.	l. cm.	pcs/pz
48306-01	9	1000

**Birch, double pointed, individually wrapped.**  
Betulla, 2 punte, imbustati singolarmente.



**SS**

**Cocktail picks, 4 pcs**  
Spiedini cocktail, 4 pz  
Cocktailspiese, 4 Stk  
Brochettes, 4 pièces  
Palos, 4 piezas

art.	l. cm.	col.
41492-00	10	●
41492G00	10	●
41492C00	10	●
41492B00	10	●



**PC**

**Glass clip holder**  
Clip reggibicchiere  
Glashalter  
Clip porte-verre  
Soporte para vidrio

art.	U. Pack
44048-99	100



**PS**

**Spits, disposable**  
Spiedini, monouso  
Fleischspieße, einweg  
Brochettes, usage unique  
Palos, desechables

art.	l. cm.	pcs/pz
48364-09	9	500
48364-12	12	500



**PS**

**Forks, disposable**  
Forchettine monouso  
Gabeln, einweg  
Fourchettes, usage unique  
Tenedores, desechables

art.	l. cm.	pcs/pz
48362-01	8,5	500



**PS**

**Spoons, disposable**  
Cucchiaini monouso  
Löffel, einweg  
Cuillères, usage unique  
Cucharitas, desechables

art.	l. cm.	pcs/pz
48363-01	8,5	500



# BAR HAPPY HOUR

APPETIZERS  
AMUSE-BOUCHE



SS

**Snack holder**  
Porta snack  
Snack-Behälter  
Conteneur à snack  
Contenedor para snack

art.	Ø cm.	h. cm.	lt.
41524-09	9	8,5	0,33



SS

**Snack holder, 4 pcs**  
Porta snack, 4 pz  
Snack-Behälter, 4 Stk  
Conteneur à snack, 4 pcs  
Contenedor para snack, 4 pz

art.	Ø cm.	h. cm.	lt.
41524-04	7	6,5	0,15



SS

**Snack holder**  
Porta snack  
Snack-Behälter  
Conteneur à snack  
Contenedor para snack

art.	dim. cm.
41527-12	10x8,5x6,5
41527-13	13x10,5x9



SS

**Snack holder**  
Porta snack  
Snack-Behälter  
Conteneur à snack  
Contenedor para snack

art.	dim. cm.
41527-10	21,5x10,5x4,5
41527-11	26x13x5



SS

**Snack holder**  
Porta snack  
Snack-Behälter  
Conteneur à snack  
Contenedor para snack

art.	Ø cm.	h. cm.
41523-08	8	7,5
41523-09	9	8,5



SS

**Snack holder**  
Mini tegame  
Mini-Servierfanne  
Conteneur à snack  
Contenedor para snack

art.	dim. cm.	lt.
41522-14	14,5x9,5x4,5	0,5





SS  
PVD

**Snack holder**

Porta snack  
Snack-Behälter  
Conteneur à snack  
Contenedor para snack

art.	dim. cm.	col.
41527G10	21,5x10,5x4,5	●
41527G11	26x13x5	●



SS  
PVD

**Snack holder**

Porta snack  
Snack-Behälter  
Conteneur à snack  
Contenedor para snack

art.	dim. cm.	col.
41527G12	10x8,5x6,5	●
41527G13	13x10,5x9	●



SS  
PVD

**Snack holder**

Porta snack  
Snack-Behälter  
Conteneur à snack  
Contenedor para snack

art.	Ø cm.	h. cm.	col.
41523G08	8	7,5	●
41523G09	9	8,5	●



SS

**Snack holder**

Porta snack  
Snack-Behälter  
Conteneur à snack  
Contenedor para snack

art.	Ø cm.	h. cm.	lt.
41524-10	9,5	11,5	0,45



SS

**Snack holder**

Porta snack  
Snack-Behälter  
Conteneur à snack  
Contenedor para snack

art.	Ø cm.	h. cm.	lt.
41524-11	8,5	8,5	0,35



SS

**Snack holder**

Porta snack  
Snack-Behälter  
Conteneur à snack  
Contenedor para snack

art.	Ø cm.	h. cm.	lt.
41524-12	8,5	8,5	0,35



SS  
PVD

**Snack holder**

Porta snack  
Snack-Behälter  
Conteneur à snack  
Contenedor para snack

art.	Ø cm.	h. cm.	lt.	col.
41524C10	9,5	11,5	0,45	●



SS  
PVD

**Snack holder**

Porta snack  
Snack-Behälter  
Conteneur à snack  
Contenedor para snack

art.	Ø cm.	h. cm.	lt.	col.
41524C11	8,5	8,5	0,35	●



SS  
PVD

**Snack holder**

Porta snack  
Snack-Behälter  
Conteneur à snack  
Contenedor para snack

art.	Ø cm.	h. cm.	lt.	col.
41524C12	8,5	8,5	0,35	●



W

**5 pcs tasting/dessert set**

Set 5 pz aperitivo/degustazione  
5 Stück Verkostung/Dessert Set  
Set 5 pcs dégustation/dessert  
Juego de degustación/postre 5 pz

art.	dim. cm.	ml.
41205-07	42x9x1,8 4x68	



W

**4 pcs canning jar set**

Set 4 pz barattoli degustazione  
4 Stück Verkostung-Gläser Set  
Set 4 pcs dégustation/dessert  
Juego de degustación/postre 4 pz

art.	dim. cm.	ml.
41205-08	27,5x11x4 3x200	



W

**7 pcs canning jar set**

Set 7 pz barattoli degustazione  
5 Stück Verkostung-Gläser Set  
Set 7 pcs dégustation/dessert  
Juego de degustación/postre 5 pz

art.	dim. cm.	ml.
41205-09	43x10x3 6x100	



**BAR HAPPY HOUR  
APPETIZERS AMUSE-BOUCHE**

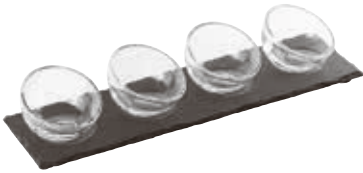

**AR**

**5 pcs tasting/dessert set**  
Set 5 pz aperitivo/degustazione  
5 Stück Verkostung/Dessert Set  
Set 5 pcs dégustation/dessert  
Juego de degustación/postre 5 pz  
.....  
art. dim. cm. ml.  
41205-01 35x10 4x43



**AR**

**5 pcs tasting/dessert set**  
Set 5 pz aperitivo/degustazione  
5 Stück Verkostung/Dessert Set  
Set 5 pcs dégustation/dessert  
Juego de degustación/postre 5 pz  
.....  
art. dim. cm. ml.  
41205-02 35x10 4x110



**W**

**5 pcs tasting/dessert set**  
Set 5 pz aperitivo/degustazione  
5 Stück Verkostung/Dessert Set  
Set 5 pcs dégustation/dessert  
Juego de degustación/postre 5 pz  
.....  
art. dim. cm. ml.  
41205-03 49x9,7x1,8 4x176



**W**

**4 pcs tasting/dessert set**  
Set 4 pz aperitivo/degustazione  
4 Stück Verkostung/Dessert Set  
Set 4 pcs dégustation/dessert  
Juego de degustación/postre 4 pz  
.....  
art. dim. cm. ml.  
41205-04 35x11x1,8 3x147



**W**

**4 pcs tasting/dessert set**  
Set 4 pz aperitivo/degustazione  
4 Stück Verkostung/Dessert Set  
Set 4 pcs dégustation/dessert  
Juego de degustación/postre 4 pz  
.....  
art. dim. cm. ml.  
41205-05 45x11x1,8 3x147



**W**

**5 pcs tasting/dessert set**  
Set 5 pz aperitivo/degustazione  
5 Stück Verkostung/Dessert Set  
Set 5 pcs dégustation/dessert  
Juego de degustación/postre 5 pz  
.....  
art. dim. cm.  
41205-06 45x9x1,8



**W**

**4 pcs tasting/dessert set**  
Set 4 pz aperitivo/degustazione  
4 Stück Verkostung/Dessert Set  
Set 4 pcs dégustation/dessert  
Juego de degustación/postre 4 pz  
.....  
art. dim. cm.  
41205-10 35x11x2



**W**

**7 pcs tasting/dessert set**  
Set 7 pz aperitivo/degustazione  
7 Stück Verkostung/Dessert Set  
Set 7 pcs dégustation/dessert  
Juego de degustación/postre 7 pz  
.....  
art. dim. cm.  
41206-04 38x12x1



**TRAYS**  
VASSOI PLANK



In reinforced polyester, suitable for food contact, dishwasher safe. Natural rough finish and elegant at the same time. They can be used as showplate and as presentation tray as well. Available in 3 colors. Non-slip foot available on request item 41323-AA.

Plance in poliestere rinforzato, idoneo al contatto alimentare, lavabile in lavastoviglie. Finitura ruvida naturale ed elegante al tempo stesso. Possono essere utilizzate come piatto presentazione e come vassoi espositivi. Disponibili in 3 colorazioni. Piedini antiscivolo in opzione art. 41323-AA.



**Tray, rectangular**  
Plancia rettangolare  
Platte, rechteckig  
Plateau rectangulaire  
Placa rectangular

art.	dim. cm.	col.
41323-11	30x20x0,5	●
41323-12	40x20x0,5	●
41323-13	40x30x0,5	●
41323-14	60x40x0,5	●



**Tray, rectangular**  
Plancia rettangolare  
Platte, rechteckig  
Plateau rectangulaire  
Placa rectangular

art.	dim. cm.	col.
41323-21	30x20x0,5	●
41323-22	40x20x0,5	●
41323-23	40x30x0,5	●
41323-24	60x40x0,5	●



**Tray, rectangular**  
Plancia rettangolare  
Platte, rechteckig  
Plateau rectangulaire  
Placa rectangular

art.	dim. cm.	col.
41323-01	30x20x0,5	●
41323-02	40x20x0,5	●
41323-03	40x30x0,5	●
41323-04	60x40x0,5	●



**HDPE**



**Tray support**  
Supporto per vassoi  
Tablett Unterstützung  
Support pour plateaux  
Soporte para bandejas

art.	dim. cm.	U. Pack
41323-99	5x5x6	24





TRAYS WOOD EFFECT  
VASSOI EFFETTO LEGNO



**Rectangular platter**  
Vassoio rettangolare  
Tablett, Rechteckig  
Plateau rectangulaire  
Bandeja rectangular

art.	dim. cm.
44473-31	53x32,5x0,8
44473-32	32,5x26,5x0,8
44473-34	26x16x0,8
44473-33	32,5x17,5x0,8



**Round platter**  
Vassoio rotondo  
Tablett, Rund  
Plateau rond  
Bandeja redonda

art.	Ø cm.	h. cm.
44473-02	33	0,8
44473-03	43	0,8



**Round platter with handle**  
Vassoio rotondo con manico  
Tablett, Rund mit Griff  
Plateau rond avec manche  
Bandeja redonda con mango

art.	Ø cm.	h. cm.
44473-05	38	1,5



**Rectangular platter with handle**  
Vassoio rettangolare con manico  
Tablett Rechteckig mit Griff  
Plateau rectangulaire avec manche  
Bandeja rectangular con mango

art.	dim. cm.
44473-07	53x20x1,5



**Rectangular platter with handle**  
Vassoio rettangolare con manico  
Tablett Rechteckig mit Griff  
Plateau rectangulaire avec manche  
Bandeja rectangular con mango

art.	dim. cm.
44473-08	61x20x1,5



**Tray, rectangular**  
Plancia rettangolare  
Platte, rechteckig  
Plateau rectangulaire  
Placa rectangular

art.	dim. cm.
44471-11	53x32,5x1,5
44471-12	32,5x26,5x1,5
44471-13	32,5x17,6x1,5
44471-14	26,5x16,2x1,5
44471-24	53x16,2x1,5



WOODEN SERVING BOARDS  
TAGLIERI IN LEGNO



Each piece is carefully handcrafted therefore size, shape and finish may vary from piece to piece. Wash by hand with warm soapy water, do not to soak.

Ogni pezzo è realizzato a mano quindi dimensioni, forma e finitura variano da pezzo a pezzo. Lavare a mano con acqua tiepida e sapone. Non mettere in ammollo.



Serving board  
Tagliere  
Servier-Brett  
Planche de service  
Tabla

art.	dim. cm.
41327-01	45,5x20

Acacia wood. – Acacia.



Bowl  
Ciotola  
Schüssel  
Bol  
Bol

art.	Ø cm.
41327-02	25,5

Acacia wood. – Acacia.



Serving board  
Tagliere  
Servier-Brett  
Planche de service  
Tabla

art.	Ø cm.
41327-03	20,0
41327-04	25,5
41327-05	30,5

Acacia wood. – Acacia.



Serving board  
Tagliere  
Servier-Brett  
Planche de service  
Tabla

art.	Ø cm.
41327-06	19,5
41327-07	24,0
41327-08	29,5

Acacia wood. – Acacia.



Serving board  
Tagliere  
Servier-Brett  
Planche de service  
Tabla

art.	Ø cm.
41327-09	24
41327-10	30

Acacia wood. – Acacia.



Serving board  
Tagliere  
Servier-Brett  
Planche de service  
Tabla

art.	dim. cm.
41320-25	25x17x1,5
41320-30	30x20,5x2
41320-35	35x24x2

Olive wood. – Ulivo.





W

**Serving board**

Tagliere  
Servier-Brett  
Planche de service  
Tabla

art.	dim. cm.	l.
41321-40	40x15x1,5	40+11
41321-44	44x20x2	44+12

Olive wood. – Ulivo.



W

**Serving board**

Tagliere  
Servier-Brett  
Planche de service  
Tabla

art.	dim. cm.	l.
41322-19	19x12,2x1,5	19+6
41322-25	25x16x1,5	25+8
41322-31	31x20x1,5	31+9

Olive wood. – Ulivo.



W

**Serving board**

Tagliere  
Servier-Brett  
Planche de service  
Tabla

art.	dim. cm.
41325-20	20x12x3

Birch wood. – Betulla.



W

**Serving board**

Tagliere  
Servier-Brett  
Planche de service  
Tabla

art.	dim. cm.
41325-30	30x20x3

Birch wood. – Betulla.



W

**Serving board**

Tagliere  
Servier-Brett  
Planche de service  
Tabla

art.	dim. cm.
41325-40	40x15x3

Birch wood. – Betulla.



W

AR

**Serving board set 4 pieces**

Tagliere set 4 pezzi  
Servier-Brett, 4-tlg  
Planche de service, set 4 pièces  
Tabla juego 4 piezas

art.	dim. cm.
41206-01	35x23x1,5

Pine wood. – Pino.



W

AR

**Serving board set 3 pieces**

Tagliere set 3 pezzi  
Servier-Brett, 3-tlg  
Planche de service, set 3 pièces  
Tabla juego 3 piezas

art.	dim. cm.
41206-02	37x17x1,8

Pine wood. – Pino.



W

**Coffee set 4 pieces**

Servizio caffè 4 pezzi  
Kaffeaset 4 Stk  
Service à café 4 pièces  
Servicio de café 4 piezas

art.	dim. cm.
41206-03	25x18,7x2,5

Acacia wood. – Acacia.



AR

W

**Serving board**

Tagliere  
Servier-Brett  
Planche de service  
Tabla

art.	dim. cm.
41326-30	30,5x13x1,5

Acacia wood. – Acacia.



AR

W

**Serving board**

Tagliere  
Servier-Brett  
Planche de service  
Tabla

art.	dim. cm.
41326-36	36,5x15x1,5

Acacia wood. – Acacia.



AR

W

**Serving board**

Tagliere  
Servier-Brett  
Planche de service  
Tabla

art.	dim. cm.
41326-42	42x18x1,5

Acacia wood. – Acacia.





W  
AR

**Serving stand 2-tier**

Alzata 2 piani  
Servierstand 2-stufig  
Support 2 niveaux  
Soporte 2 pisos

art. dim. cm.

41207-02 25x4,5x34,5

**Beech. Slate cm. 31x13 - 41x18.**  
Faggio. Ardesia cm. 31x13 - 41x18.



W  
AR

**Serving stand 3-tier**

Alzata 3 piani  
Servierstand 3-stufig  
Support 3 niveaux  
Soporte 3 pisos

art. dim. cm.

41207-03 25x4,5x54

**Beech. Slate cm. 21x8 - 31x13 - 41x18.**  
Faggio. Ardesia cm. 21x8 - 31x13 - 41x18.



W

**Serving board with cast iron surface**

Tagliere con inserto ghisa  
Servierplatte mit Gusseiseneinsatz  
Planche à servir avec insert en fonte  
Tabla con inserto de hierro fundido

art. Ø cm. Por.

44250S30 30 1-2

**Iroko wood.** – Iroko.



W

**Serving board with cast iron surface**

Tagliere con inserto ghisa  
Servierplatte mit Gusseiseneinsatz  
Planche à servir avec insert en fonte  
Tabla con inserto de hierro fundido

art. dim. cm. Por.

44248S60 60x15x2,5 4

**Iroko wood.** – Iroko.



W

**Serving board with cast iron surface**

Tagliere con inserto ghisa  
Servierplatte mit Gusseiseneinsatz  
Planche à servir avec insert en fonte  
Tabla con inserto de hierro fundido

art. Ø cm. h. cm. Por.

44254-30 31 2,5 1

**Iroko wood.** – Iroko.



W

**Wooden service platter**

Tagliere legno  
Holzbrett  
Planche à servir en bois  
Tabla madera

art. dim. cm. Por.

44258-60 60x15 4-6

**Iroko wood.** – Iroko.



W

**Wooden service platter**

Tagliere legno  
Holzbrett  
Planche à servir en bois  
Tabla madera

art. dim. cm. Por.

44264-35 25x35x1,8 1-2

**Iroko wood.** – Iroko.



W

**Wooden service platter**

Tagliere legno  
Holzbrett  
Planche à servir en bois  
Tabla madera

art. dim. cm. Por.

44265-35 25x35x1,8 1-2

**Iroko wood.** – Iroko.



W

**Twice sauce pot wooden platter**

Porta coppette doppio  
Schale-Träger doppel  
Support à bol double  
Soporte copa doble

art. Ø cm. dim. cm.

44256-02 5,5 8x20x1,8

**Beechwood.** – Faggio.



W

**Triple sauce pot wooden platter**

Porta coppette triplo  
Schale-Träger dreifach  
Support à bol triple  
Soporte copa triple

art. Ø cm. dim. cm.

44256-03 5,5 8x28x1,8

**Beechwood.** – Faggio.



W

**Quartet sauce pot wooden platter**

Porta coppette quadruplo  
Schale-Träger vierfach  
Support à bol quadruple  
Soporte copa cuatro veces

art. Ø cm. dim. cm.

44256-04 5,5 8x36x1,8

**Beechwood.** – Faggio.



MF

**Bowl**  
Ciotola  
Schale  
Bol  
Bol

art.	Ø cm.	h. cm.	lt.
44846B05	5,5	4	0,02



MF

**Bowl**  
Ciotola  
Schale  
Bol  
Bol

art.	dim. cm.	lt.
44466-11	7,5x7x4,5	0,05



MF

**Bowl**  
Ciotola  
Schale  
Bol  
Bol

art.	dim. cm.	lt.
44466-12	11,5x7,5x3	0,06



MF

**Bowl**  
Ciotola  
Schale  
Bol  
Bol

art.	dim. cm.	lt.
44466-13	11,5x6x5,5	0,04



MF

**Bowl**  
Ciotola  
Schale  
Bol  
Bol

art.	dim. cm.	lt.
44466-14	8,5x7x6	0,07



MF

**Bowl**  
Ciotola  
Schale  
Bol  
Bol

art.	dim. cm.	lt.
44466-15	8x8x4	0,1

NATURAL ELEGANT



A valid alternative to glass. Elegant and unbreakable ideal for HORECA pastry and ice cream sector. Made with high quality material that confers beside resistance also glossiness and perfect transparency. Bisphenol free. Thermal tolerance -18°C +70°C. 100% recyclable material. Dishwasher safe: up to 50 washes. Made in Italy.

La valida alternativa al vetro. Eleganti ed infrangibili ideali per il settore HORECA della pasticceria e gelateria. Realizzati con materiale di alta qualità che gli conferisce oltre alla resistenza anche lucidità e trasparenza. Privi di Bisfenolo. Tolleranza termica -18°C +70°C. Materiale riciclabile al 100%. Lavabili in lavastoviglie: fino a 50 lavaggi. Prodotti made in Italy.



PS

**Tasting glass**  
Bicchierino degustazione  
Verkostung Glas  
Verrine dégustation  
Vaso degustación

art.	dim. cm.	h. cm.	ml.
48368-05	6,4x4,6	5,3	50
48368-12	8,5x6	7,0	120
48368-20	10x7	8,2	200

Set 100 pcs. – Conf. 100 pz.



PS

**Tasting glass**  
Bicchierino degustazione  
Verkostung Glas  
Verrine dégustation  
Vaso degustación

art.	dim. cm.	h. cm.	ml.
48369-08	6,3x6,9	5,7	85
48369-14	7,3x8,1	6,7	140
48369-20	9x8,3	7,4	200

Set 100 pcs. – Conf. 100 pz.



PS

**Tasting dish**

Piattino degustazione  
Verkostung Teller  
Assiette dégustation  
Platillo degustación

art. Ø cm.  
48372-08 8

**Set 100 pcs. – Conf. 100 pz.**



PS

**Tasting bowl**

Ciotolina degustazione  
Verkostung Schale  
Bol dégustation  
Bol degustación

art. Ø cm. ml.  
48359-01 6,5 15

**Set 100 pcs. – Conf. 100 pz.**



PS

**Tasting glass**

Bicchierino degustazione  
Verkostung Glas  
Verrine dégustation  
Vaso degustación

art. Ø cm. h. cm. ml.  
48354-01 4 8,5 70

**Set 100 pcs. – Conf. 100 pz.**



PS

**Tasting bowl**

Ciotolina degustazione  
Verkostung Schale  
Bol dégustation  
Bol degustación

art. Ø cm. ml.  
48357-01 7,5 50

**Set 100 pcs. – Conf. 100 pz.**



PS

**Tasting glass**

Bicchierino degustazione  
Verkostung Glas  
Verrine dégustation  
Vaso degustación

art. Ø cm. h. cm. ml.  
48353-01 8,5 6,5 120

**Set 100 pcs. – Conf. 100 pz.**



PS

**Tasting dish**

Piattino degustazione  
Verkostung Teller  
Assiette dégustation  
Platillo degustación

art. Ø cm. h. cm. ml.  
48355-01 9 1,5 20

**Set 100 pcs. – Conf. 100 pz.**



PS

**Tasting bowl**

Ciotolina degustazione  
Verkostung Schale  
Bol dégustation  
Bol degustación

art. dim. cm. ml.  
48358-01 10,5x5x3 11

**Set 100 pcs. – Conf. 100 pz.**



PS

**Tasting bowl**

Ciotolina degustazione  
Verkostung Schale  
Bol dégustation  
Bol degustación

art. Ø cm. ml.  
48356-01 8,5 30

**Set 100 pcs. – Conf. 100 pz.**



FINGERFOOD



**Oval tweested dish**  
Ovalina goccia  
art. dim. cm.  
41200-01 9x5x3



**Eye dish**  
Ovalina occhio  
art. dim. cm.  
41200-02 8,1x5,6x3



**Egg dish**  
Tegamino 2/m  
art. dim. cm.  
41200-03 8,5x6,8x2



**Oval dish**  
Ovalina  
art. dim. cm.  
41200-04 10x5,5x2,7



**Soya sauce dish**  
Rettangolare  
art. dim. cm.  
41200-05 8x5,5x1,8



**Square dish**  
Piatino quadro  
art. dim. cm.  
41200-06 8x8x2,4



**Oriental square dish**  
Quadrato orientale  
art. dim. cm.  
41200-07 7,5x7,5x3



**Dye dish**  
Cubo  
art. dim. cm.  
41200-08 5,2x5,2x4



**Chao dish**  
Quadrato punte  
art. dim. cm.  
41200-09 8x8x5



**Tear dish**  
Foglia  
art. dim. cm.  
41200-10 8x7x3,4



**Nem dish**  
Tronchetto  
art. dim. cm.  
41200-11 5,5x4,5x6,5



**Rectangular w/lid**  
Rettangolare c/cop  
art. dim. cm.  
41200-13 10x5,5x4,5



**Square pan with lid**  
Quadra c/cop  
art. dim. cm.  
41200-14 9x3,6x4,5



**Oval pan with lid**  
Ovale c/cop  
art. dim. cm.  
41200-15 10,5x7x4,5



**Rectangular pan**  
Casseruola rett.  
art. dim. cm.  
41200-16 10x5,5x4,5



**Square pan**  
Casseruola quadra  
art. dim. cm.  
41200-17 9x3,6x4,5





**Oval pan**  
Casseruola ovale

art. dim. cm.  
41200-18 10,5x7x4,5



**Footed square dish**  
Quadrato

art. dim. cm.  
41200-32 10x10x1,2



**Fish dish**  
Piattino pesce

art. dim. cm.  
41200-33 10,5x5x1,6



**Small pan**  
Tegamino

art. dim. cm.  
41200-34 9,7x6x2,6



**Mini pasta bowl**  
Mini ciotola pasta

art. dim. cm.  
41200-36 10x2,5x1,6



**Square dish**  
Coppetta quadra

art. dim. cm.  
41200-40 7x7x3,5



**Round bowl**  
Bolo tondo

art. Ø cm. h. cm.  
41200-41 7 4,5



**Small pot**  
Mini pentola

art. dim. cm.  
41200-49 5x5x5



**Small bucket**  
Secchiello

art. dim. cm.  
41200-50 6x6x4,5



**Colander**  
Colapasta

art. dim. cm.  
41200-51 7x7x4,5



**Fruit case**  
Cassetta frutta

art. dim. cm.  
41200-52 8x5,5x2,3



**Tin with lid**  
Scatoletta c/cop

art. dim. cm.  
41200-53 13,5x5,5x5



**Tin with lid**  
Scatoletta c/cop

art. Ø cm. h. cm.  
41200-54 13,5 4



**French fries bowl**  
Vaschetta patatine

art. dim. cm.  
41200-58 13x10x4



**Rectangular w/handles**  
Rettangolare c/m

art. dim. cm.  
41200-59 14x10x3,5



**Rectangular lid**  
Coperchio rett.

art. dim. cm.  
41200-60 14x10



**Oval w/handles**  
Ovale c/m

art. dim. cm.  
41200-61 14x9,5x3,5



**Oval lid**  
Coperchio ovale

art. dim. cm.  
41200-62 14x9,5



**Round w/handles**  
Tonda c/m

art. Ø cm. h. cm.  
41200-63 13 5,5



**Round lid**  
Coperchio tondo

art. Ø cm.  
41200-64 13



**Ramequin**  
Ramequin

art. Ø cm. h. cm.  
41200-46 10 5,0  
41200-47 9 5,0  
41200-48 8 4,5



**Vintage tray**  
Vassoietto vintage

art. dim. cm.  
41200-55 15x10x1,7



**Vintage tray**  
Vassoietto vintage

art. dim. cm.  
41200-56 22,3x14x2



**Vintage tray**  
Vassoietto vintage

art. dim. cm.  
41200-57 29,5x20,5x2



# TABLE TOP TAVOLA

SERVING ITEMS  
COMPLEMENTI





TABLE MATS & RUNNERS



Material: 50% polyester - 50% Polyvinyl chloride

Materiale: 50% Poliестere - 50% Cloruro di polivinile





**Table mat - Light melange**

Tovaglietta - Melange chiaro

art.	dim. cm.	pcs/pz
42950-01	42x33	6



**Table mat - Brown**

Tovaglietta - Marrone

art.	dim. cm.	pcs/pz
42950-04	42x33	6



**Table mat - Crispy**

Tovaglietta - Croccante

art.	dim. cm.	pcs/pz
42950-07	42x33	6



**Table mat - Sandy**

Tovaglietta - Beige

art.	dim. cm.	pcs/pz
42950-02	42x33	6



**Table mat - Beige-Grey**

Tovaglietta - Beige-Grigio

art.	dim. cm.	pcs/pz
42950-05	42x33	6



**Table mat - Coral**

Tovaglietta - Corallo

art.	dim. cm.	pcs/pz
42950-08	42x33	6

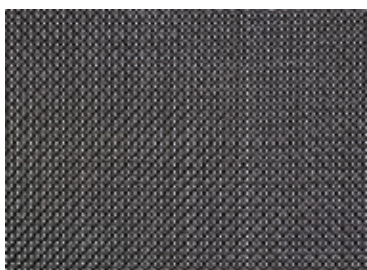

**Table mat - Black**

Tovaglietta - Nero

art.	dim. cm.	pcs/pz
42950-03	42x33	6



**Table mat - Grey**

Tovaglietta - Grigio

art.	dim. cm.	pcs/pz
42950-06	42x33	6



**Table mat - White pin-striped**

Tovaglietta - Gessato bianco

art.	dim. cm.	pcs/pz
42950-09	42x33	6



**RUNNER - Sandy  
Beige**

art.	dim. cm.
42950-92	42x180

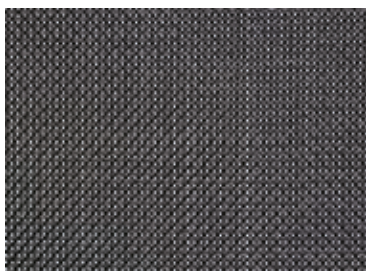

**RUNNER - Black  
Nero**

art.	dim. cm.
42950-93	42x180



**RUNNER - Brown  
Marrone**

art.	dim. cm.
42950-94	42x180

NATURAL SLATE  
ARDESIA NATURALE



Excellent coldness retention, food safe. The edges of the trays are broken to show the typical structure of the natural material. With anti-slip feet. No dishwasher proof. Material thickness: 4-7 mm.

Eccellente immagazzinamento del freddo, idonei al contatto alimentare. Gli angoli dei piani sono spezzati per evidenziare la tipica struttura del materiale. Con piedini antiscivolo. Non idonei al lavaggio in lavastoviglie. Spessore: 4-7 mm.



**Tray**  
Vassoio  
Platte  
Plateau  
Placa

art.	dim. cm.
41585-37	20x10



**Tray**  
Plancia  
Platte  
Plateau  
Placa

art.	GN	dim. cm.
41585-11	1/1	53x32,2
41585-12	1/2	32,5x26,5
41585-13	1/3	32,5x17,5
41585-24	1/4	26,5x16,5
41585-23	2/4	53x16,2



**Square tray**  
Plancia quadra  
Platte, viereckig  
Plateau carré  
Placa cuadrada

art.	dim. cm.
41585-25	25x25
41585-30	30x30





**Rectangulat tray**

Plancia rettangolare  
Platte, rechteckig  
Plateau rectangulaire  
Placa rectangular

art.	dim. cm.
41585-45	45x30



**Round tray**

Plancia tonda  
Platte, rund  
Plaque ronde  
Placa redonda

art.	Ø cm.
41586-22	22
41586-28	28
41586-33	33
41586-38	38



**Square tray, 4 pcs set**

Plancia quadra, set 4 pz  
Platte, viereckig, Satz 4 Stk  
Plateau carré, set 4 pcs  
Placa cuadrada, juego 4 pz

art.	dim. cm.
41585-10	10x10



**Tray with holes**

Vassoio con fori  
Platte mit Absätze  
Plat avec trous  
Placa con agujeros

art.	Ø cm.	dim. cm.
41585-01	6	25x12



**Tray with holes**

Vassoio con fori  
Platte mit Absätze  
Plat avec trous  
Placa con agujeros

art.	Ø cm.	dim. cm.
41585-02	6	15x8



**Tray with holes**

Vassoio con fori  
Platte mit Absätze  
Plat avec trous  
Placa con agujeros

art.	Ø cm.	dim. cm.
41585-03	6	28x10



**Tray with dome**

Piatto con campana  
Platte mit Glashaube  
Plat avec cloche  
Bandeja y campana

art.	Ø cm.	h. cm.
41585-00	10,5	8



**Tray 2-tier**

Alzata 2 piani  
Etagère 2-stufig  
Présentoir 2 niveaux  
Bandeja 2 niveles

art.	Ø cm.	h. cm.
41587-25	20-25	24



**Revolving platter**

Supporto girevole  
Servierplatt, drehbar  
Présentoir tournant  
Soporte rotatorio

art.	Ø cm.	h. cm.
41587-32	32	2,5



**Tray**

Plancia  
Platte  
Plateau  
Placa

art.	dim. cm.	fits/per
41585-51	24x15	44842-30
41585-52	47x10	44843-24
41585-53	26,5x20,5	44843-12
41585-54	32x12	44842-35

41585-52 + 44843-24



41585-54 + 44842-35



41585-53 + 44843-12



41585-51 + 44842-30



**BLACK & BROWN**  
NERO & MARRONE



The rough surface structure creates a natural appearance. The black bowls and trays with brown border stage your dishes in a very stylish way.

La struttura superficiale ruvida crea un aspetto naturale. Le ciotole e i vassoi neri con bordo marrone mettono in scena le pietanze in modo molto elegante.



**Bowl**  
Ciotola  
Schüssel  
Bol  
Bol

art.	Ø cm.	h. cm.	lt.
44480-10	14	6,0	0,3
44480-11	19	8,0	0,8
44480-12	21	8,5	1,0
44480-13	24	9,5	1,4



**Bowl**  
Ciotola  
Schüssel  
Bol  
Bol

art.	Ø cm.	h. cm.	lt.
44480-15	11	3,5	0,13
44480-16	14	4,0	0,20
44480-20	30,5	8,5	2,00



**Bowl**  
Ciotola  
Schüssel  
Bol  
Bol

art.	dim. cm.	lt.
44480-14	23,5x23,5x6,5	0,7



**Tray**  
Vassoio  
Tablett  
Plateau  
Bandeja

art.	dim. cm.
44480-03	14,5x14,5x2



**Tray**  
Vassoio  
Tablett  
Plateau  
Bandeja

art.	dim. cm.
44480-06	26,5x16,5x4



**Bowl**  
Ciotola  
Schüssel  
Bol  
Bol

art.	Ø cm.	h. cm.	lt.
44480-07	8,5	2,5	0,05



**Bowl**  
Ciotola  
Schüssel  
Bol  
Bol

art.	Ø cm.	h. cm.	lt.
44480-08	11,5	3	0,04



**Bowl**  
Ciotola  
Schüssel  
Bol  
Bol

art.	Ø cm.	h. cm.	lt.
44480-09	11	5,5	0,2



**Tray**  
Vassoio  
Tablett  
Plateau  
Bandeja

art.	dim. cm.
44480-19	32,5x23,5x4,5



**Bowl**

Ciotola  
Schüssel  
Bol

art.	dim. cm.	lt.
44480-00	25,5x14x5,5	0,4
44480-01	36x19x8	0,9

**Tray**

Vassoio  
Tablett  
Plateau

Bandeja

art.	dim. cm.
44480-04	22,5x15x3
44480-05	27,5x11x2

**Tray**

Vassoio  
Tablett  
Plateau

Bandeja

art.	dim. cm.
44480-17	19,5x9,5x2
44480-18	39x16x3

## CLAY ARGILLA



Serving and buffet items, an imitation of clay, either white with brown border or dark brown with terracotta border. The surface is inside and outside fine-matt. Feels like real clay.

Piatti da servizio e buffet, un'imitazione dell'argilla, sia bianchi con bordo marrone o moro con bordo terracotta. La superficie interna ed esterna è finemente opaca. Effetto argilla anche al tatto.

**Soup plate**

Piatto fondo  
Teller tief  
Assiette creuse  
Plato hondo

art.	Ø cm.	h. cm.	lt.	col.
44478-20	20,5	3	0,5	●

**Soup plate**

Piatto fondo  
Teller tief  
Assiette creuse  
Plato hondo

art.	Ø cm.	h. cm.	lt.	col.
44478-21	20,5	3	0,5	●

**Flat plate**

Piatto piano  
Teller flach  
Assiette plate  
Plato llano

art.	dim. cm.	col.
44478-22	14x13x2,5	●



**Flat plate**

Piatto piano  
Teller flach  
Assiette plate  
Plato llano

art.	dim. cm.	col.
44478-23	14x13x2,5	●



**Bowl**

Ciotola  
Schüssel  
Bol

art.	Ø cm.	h. cm.	lt.	col.
44478-24	12,5	6	0,37	●
44478-26	16	7	0,70	●



**Bowl**

Ciotola  
Schüssel  
Bol

art.	Ø cm.	h. cm.	lt.	col.
44478-25	12,5	6	0,37	●
44478-27	16	7	0,70	●



**Bowl**

Ciotola  
Schüssel  
Bol  
Bol

art.	Ø cm.	h. cm.	lt.	col.
44478-28	16,5	4	0,5	●



**Bowl**

Ciotola  
Schüssel  
Bol  
Bol

art.	Ø cm.	h. cm.	lt.	col.
44478-29	16,5	4	0,5	●



**Bowl**

Ciotola  
Schüssel  
Bol  
Bol

art.	Ø cm.	h. cm.	lt.	col.
44478-30	21	8	1,45	●



**Bowl**

Ciotola  
Schüssel  
Bol  
Bol

art.	Ø cm.	h. cm.	lt.	col.
44478-31	21	8	1,45	●



**Bowl**

Ciotola  
Schüssel  
Bol  
Bol

art.	dim. cm.	lt.	col.
44478-32	30,5x10x7,5	0,17	●
44478-34	42x14x9,5	0,65	●



**Bowl**

Ciotola  
Schüssel  
Bol  
Bol

art.	dim. cm.	lt.	col.
44478-33	30,5x10x7,5	0,17	●
44478-35	42x14x9,5	0,65	●



**Serving box 7 pieces**

Servizio pranzo 7 pezzi  
Servierbox 7 Stück  
Boîte repas 7 pièces  
Caja comida 7 piezas

art.	dim. cm.
44357-07	30x25x8

**For indoor & outdoor use. Perfect for room, pool and beach service. Set consisting of 1 box + 1 cover, 1 large bowl cm 23x14x6 Lt 1,4 - 1 medium bowl cm 14x11,5x6 Lt 0,6 - 2 small bowls cm 11,5x7x6 Lt 0,25 - 1 non-slip mat cm 26x21. Cover and box in wooden look, inside white.**

Per uso interno ed esterno. Perfetto per servizio in camera, piscina e spiaggia. Set composto da 1 box + 1 coperchio, 1 ciotola grande cm 23x14x6 Lt 1,4 - 1 ciotola media cm 14x11,5x6 Lt 0,6 - 2 ciotole piccole cm 11,5x7x6 Lt 0,25 - 1 tappetino antiscivolo cm 26x21. Coperchio e box effetto legno, interno bianco.

**NEW**

**MF**

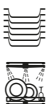



GLASS JARS  
VASETTI WECK

Perfect for the sterilization and pasteurization of any product, fruit, vegetables, but also meat, fish, foie gras or delicatessen products. They are suitable for serving jams and sauces: they also look beautiful on the table. They are perfect for cooking and serving on the table. They are 100% pure glass, so they do not release harmful substances into food, they resist very high temperatures (up to 200°C in the oven), they can be washed in the dishwasher (including seal).

Perfetti per la sterilizzazione e la pastorizzazione di qualsiasi prodotto, di frutta verdura ma anche di carne, pesce, foie gras o prodotti di salumeria. Sono indicati per servire marmellate e salse di accompagnamento: inoltre belli da vedere sulla tavola. Sono i vasetti perfetti per la vasocottura e per servire in tavola. Sono al 100% in puro vetro, quindi non rilasciano sostanze nocive nel cibo, resistono a temperature elevatissime (fino a 200°C in forno), si possono lavare in lavastoviglie (guarnizione compresa).



**Glasses with cover, 12 pcs**  
Vasetti con coperchio, 12 pz  
Gläser mit Deckel, 12er Set  
Verres avec couvercle, 12 pcs  
Vasos con tapa, 12 pz

art.	Ø cm.	h. cm.	ml.
41589-08	6	5,5	80
41589-14	6	7,0	140



**Glasses with cover, 12 pcs**  
Vasetti con coperchio, 12 pz  
Gläser mit Deckel, 12er Set  
Verres avec couvercle, 12 pcs  
Vasos con tapa, 12 pz

art.	Ø cm.	h. cm.	ml.
41589-16	6	8	160



**Glasses with cover, 12 pcs**  
Vasetti con coperchio, 12 pz  
Gläser mit Deckel, 12er Set  
Verres avec couvercle, 12 pcs  
Vasos con tapa, 12 pz

art.	Ø cm.	h. cm.	ml.
41589-20	9	6	200



**Glasses with cover, 12 pcs**  
Vasetti con coperchio, 12 pz  
Gläser mit Deckel, 12er Set  
Verres avec couvercle, 12 pcs  
Vasos con tapa, 12 pz

art.	Ø cm.	h. cm.	ml.
41589-22	7	8	220



**NEW**

**Glasses with cover, 12 pcs**  
Vasetti con coperchio, 12 pz  
Gläser mit Deckel, 12er Set  
Verres avec couvercle, 12 pcs  
Vasos con tapa, 12 pz

art.	Ø cm.	h. cm.	ml.
41589-07	5,5	6	75



**NEW**

**Glasses with cover, 12 pcs**  
Vasetti con coperchio, 12 pz  
Gläser mit Deckel, 12er Set  
Verres avec couvercle, 12 pcs  
Vasos con tapa, 12 pz

art.	Ø cm.	h. cm.	ml.
41589-15	5,5	9	145



**NEW**

**Glasses with cover, 6 pcs**  
Vasetti con coperchio, 6 pz  
Gläser mit Deckel, 6er Set  
Verres avec couvercle, 6 pcs  
Vasos con tapa, 6 pz

art.	Ø cm.	h. cm.	ml.
41589-29	9	9	290



**NEW**

**Glasses with cover, 6 pcs**  
Vasetti con coperchio, 6 pz  
Gläser mit Deckel, 6er Set  
Verres avec couvercle, 6 pcs  
Vasos con tapa, 6 pz

art.	Ø cm.	h. cm.	ml.
41589-59	11	9	580



**Glasses with cover, 2 pcs**  
Vasetti con coperchio, 2 pz  
Gläser mit Deckel, 2er Set  
Verres avec couvercle, 2 pcs  
Vasos con tapa, 2 pz

art.	Ø cm.	h. cm.	ml.
41589-58	11	11	580



**Glasses with cover, 3 pcs**  
Vasetti con coperchio, 3 pz  
Gläser mit Deckel, 3er Set  
Verres avec couvercle, 3 pcs  
Vasos con tapa, 3 pz

art.	Ø cm.	h. cm.	ml.
41589-37	11	7,5	370



**Bottles with cover, 6 pcs**  
Bottigliette con coperchio, 6 pz  
Flaschen mit Deckel, 6er Set  
Bouteilles avec couvercle, 6 pcs  
Botellas con tapa, 6 pz

art.	Ø cm.	h. cm.	ml.
41589-25	6,5	14,5	250



**Bottles with cover, 6 pcs**  
Bottigliette con coperchio, 6 pz  
Flaschen mit Deckel, 6er Set  
Bouteilles avec couvercle, 6 pcs  
Botellas con tapa, 6 pz

art.	Ø cm.	h. cm.	ml.
41589-50	6,5	19	500



**Bottles with cover, 6 pcs**  
Bottigliette con coperchio, 6 pz  
Flaschen mit Deckel, 6er Set  
Bouteilles avec couvercle, 6 pcs  
Botellas con tapa, 6 pz

art.	Ø cm.	h. cm.	ml.
41589-99	6,5	25,5	1000





**Rubber rings, 10 pcs**

Guarnizioni, 10 pz  
Gummidichtringe, 10er Set  
Joints, 10 pièces  
Juntas, 10 piezas

art.	Ø cm.	fits/per
41589-AA	6	08/14/16
41589-BB	9	20/29
41589-CC	11	37/58/59



**Airtight covers, 5 pcs**

Coperchi ermetici, 5 pz  
Frischhaltedeckel, 5er Set  
Couvercles hermétiques, 5 pz  
Tapas herméticas, 5 pz

art.	fits/per
41589-AC	08/14/16 25/50/99



**Cover clamps, 8 pcs**

Clip, 8 pezzi  
Deckel-Klammer, 8er Set  
Clips crochets, 8 pcs  
Abrazaderas, 8 pz

art.
41589-AB

SS



**Glasses (without lid), 12 pcs**

Vasetti (senza coperchi), 12 pz  
Gläser (ohne Deckel), 12er Set  
Verres (sans couvercle), 12 pcs  
Vasos (sin tapa), 12 pz

art.	Ø cm.	h. cm.	ml.
41589C08	6	5,5	80
41589C16	6	8	160



**Serving stand, chrome plated**

Supporto cromato  
Serviergestell, hartverchromt  
Présentoir, acier chromé  
Soporte, acero cromado

art.	Ø cm.	h.	fits/per
44840-28	22	33	41589-08

Without glasses. – Senza vasetti.



**Serving stand, chrome plated**

Supporto cromato  
Serviergestell, hartverchromt  
Présentoir, acier chromé  
Soporte, acero cromado

art.	Ø cm.	h.	fits/per
44840-27	22	59	41589-08/14/16

Without glasses. – Senza vasetti.



SS

**Insulated beverage server**

Caraffa termica  
Thermokanne  
Pot isotherme  
Jarra térmica

art.	lt.
41650-06	0,6
41650-10	1,0
41650-13	1,5



SS

**Insulated beverage server**

Caraffa termica  
Thermokanne  
Pot isotherme  
Jarra térmica

art.	lt.
41646-06	0,75
41646-10	1,00
41646-15	1,50
41646-20	2,00



SS

**Insulated beverage server**

Caraffa termica  
Thermokanne  
Pot isotherme  
Jarra térmica

art.	lt.
42401-10	1,0
42401-15	1,5
42401-20	2,0



SS

**Insulated beverage server**

Caraffa termica  
Thermokanne  
Pot isotherme  
Jarra térmica

art.	lt.
42405-10	1
42405-20	2



SS

PP

**Insulated beverage server**

Caraffa termica  
Thermokanne  
Pot isotherme  
Jarra térmica

art.	Ø cm.	h. cm.	lt.
42403-01	16	20	1

8 cups. – 8 tazze.



SS

PP

**Insulated beverage server**

Caraffa termica  
Thermokanne  
Pot isotherme  
Jarra térmica

art.	Ø cm.	h. cm.	lt.
42403B01	16	20	1

8 cups. – 8 tazze.



SS

**French press**

Caffettiera pressa filtro  
Kaffeebereiter  
Cafetière à piston  
Jarra para infusiones

art.	ml.	col.
42407-03	350	●
42407-06	600	●



NEW

SS

**French press**

Caffettiera pressa filtro  
Kaffeebereiter  
Cafetière à piston  
Jarra para infusiones

art.	ml.
42408-03	350
42408-06	600
42408-08	800



PC

**Water jug**

Caraffa  
Wasserkrug  
Crûche à eau  
Jarra agua

art.	Ø cm.	h. cm.	lt.
44999-09	10	15	0,9
44999-16	12	20	1,6



**Water jug**

Caraffa  
Wasserkrug  
Crûche à eau  
Jarra agua

art.	Ø cm.	h. cm.	lt.
44992-03	26	29	3



**Water jug**

Caraffa  
Wasserkrug  
Crûche à eau  
Jarra agua

art.	Ø cm.	h. cm.	lt.
44994-00	14	29	2,5



**Water jug**

Caraffa  
Wasserkrug  
Crûche à eau  
Jarra agua

art.	Ø cm.	h. cm.	lt.
44992-02	16,5	26	2



**Water jug**

Caraffa  
Wasserkrug  
Crûche à eau  
Jarra agua

art.	dim. cm.	lt.
44871-28	12x13,8	0,5
44871-30	17,4x17	1,0
44871-32	18,7x19,8	1,5
44871-34	21,6x18,8	2,0

**Withstands temperatures/Termoresistenti**  
da: **-30° +120°C.**



PP

**Lid**

Coperchio  
Deckel  
Couvercle  
Tapa

art.	dim. cm.	fits/per	U. Pack
44871-29	9,9x1,4	l. 0,5	10
44871-31	11,2x1,9	l. 1,0	10
44871-33	14x2,4	l. 1,5	10
44871-35	15,9x2,2	l. 2,0	10

**Withstands temperatures/Termoresistenti**  
da: **-40° +100°C.**



**Juice pitcher, glass**

Caraffa vetro  
Saftkanne, Glas  
Carafe à jus, verre  
Jarra zumo, vidrio

art.	Ø cm.	h. cm.	lt.
44995-15	9,5	27	1,5

**Stainless steel lid. – Coperchio inox. -10°C/+110°C**



**Juice pitcher, glass**

Caraffa vetro  
Saftkanne, Glas  
Carafe à jus, verre  
Jarra zumo, vidrio

art.	Ø cm.	h. cm.	lt.
44995-14	16	27	1,4

**Spout opens and closes automatically. Chromed foot with cooler, keep drinks chilled up to 4 hours. – Tappo apre e chiude automaticamente. Piede cromato con eutettico, mantiene le bevande refrigerate fino a 4 ore.**



**Juice pitcher, glass**

Caraffa vetro  
Saftkanne, Glas  
Carafe à jus, verre  
Jarra zumo, vidrio

art.	Ø cm.	h. cm.	lt.
44995-10	9,5	29	1

**Spout opens and closes automatically while serving. – Tappo versatore apre e chiude automaticamente.**



PC

PP

**Juice pitcher with lid**

Caraffa con coperchio  
Saftkanne mit Deckel  
Carafe à jus avec couvercle  
Jarra zumo con tapa

art.	Ø cm.	h. cm.	lt.
44993-01	11	30	1,6

**Screwed lid, aroma-tight. Coperchio avvitato, a tenuta di aroma.**



SS

**Tea strainer**  
Passathé  
Teesieb  
Passoire à thé  
Colador de tè

art. Ø cm.  
41529-05 5



SS

**Tea strainer**  
Passathé  
Teesieb  
Passoire à thé  
Colador de tè

art. Ø cm.  
41530-05 5



SS

**Tea strainer**  
Passathé  
Teesieb  
Passoire à thé  
Colador de tè

art. Ø cm.  
41530-11 5



SS

**Tea strainer**  
Passathé  
Teesieb  
Passoire à thé  
Colador de tè

art. Ø cm.  
41530-07 7,5



SS

**Tea strainer**  
Passathé  
Teesieb  
Passoire à thé  
Colador de tè

art. Ø cm.  
42617-04 4,5  
42617-05 5,0  
42617-06 6,5  
42617-07 7,5

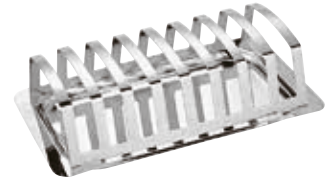

SS

**Toast rack**  
Portatoast  
Toastständer  
Support pour toast  
Porta tostadas

art. dim. cm.  
41599-08 20x11x5,7



SS

**Egg cup**  
Portauovo  
Eierbecher  
Coquetier  
Soporte huevos

art. Ø cm.  
41598-00 8,5



MF

**Egg cup, 4 pcs set**  
Portauovo, set 4 pz  
Eierbecher, 4 Stk  
Coquetier, set 4 pcs  
Soporte huevos, set 4 pz

art. Ø cm.  
41597-04 8,5



SS

PR

**Mustard cup**  
Senapiera  
Senfschale  
Moutardier  
Mostacero

art. Ø cm.  
41564-07 7



SS

PR

**Butter cup**  
Coppa burro  
Butterservierer  
Coupe à beurre  
Copa mantequilla

art. Ø cm.  
41563-07 7



SS

PR

**Butter cup**  
Coppa burro  
Butterservierer  
Coupe à beurre  
Copa mantequilla

art. Ø cm.  
41561-09 9



SS

**Insulated sauce boat**  
Salsiera termica  
Thermo-Sauciere, doppelwandig  
Saucière isotherme  
Salsera termica

art. dim. cm. lt.  
41620-04 19x12,5x13 0,4





SS

**Gravy boat with foot**

Salsiera con piede  
Saucière mit Fuss  
Saucière sur pied  
Salsera con pie

art.	lt.
41615-01	0,15
41615-03	0,25
41615-05	0,45



PR

**Soup bowl, lion-headed**

Ciotola testa di leone  
Suppentasse Löwenkopf  
Soupière tête de lion  
Tazón cabeza de león

art.	Ø cm.	lt.
44379-05	17	0,5



PC

**Salad bowl**

Insalatiera  
Salatschüssel  
Saladier  
Bol para ensalada

art.	Ø cm.	h. cm.	lt.
44950-15	15,2	5,0	0,6
44950-20	20,3	6,5	1,7
44950-25	25,4	8,0	3,0
44950-30	30,5	10,0	5,5
44950-38	38,1	12,5	10,6



PC

**Salad bowl**

Insalatiera  
Salatschüssel  
Saladier  
Bol para ensalada

art.	dim. cm.
44357-10	24x24x10
44357-15	24x24x15



PC

**Salad bowl**

Insalatiera  
Salatschüssel  
Saladier  
Bol para ensalada

art.	dim. cm.
44357B10	24x24x10
44357B15	24x24x15



SS

**Fruit basket, oval**

Cesto frutta, ovale  
Obstschale, oval  
Panier à fruits, ovale  
Cesta fruta, oval

art.	dim. cm.
42956-19	19x15
42956-24	24,5x18
42956-28	28x21



SS

**Fruit basket, round**

Cesto frutta, tondo  
Obstschale, rund  
Panier à fruits, rond  
Cesta fruta, redonda

art.	Ø cm.
41629-17	17,0
41629-20	20,0
41629-25	25,5



**Wire basket, cotton linen**

Cesto in filo, fodera cotone  
Drahtkorb, Baumwollfutter  
Panier métallique, doublure en coton  
Cesta de alambre, forro de algodón

art.	dim. cm.
42878-17	17x12,5x8
42878-25	25x15,5x12



**Wire basket, cotton linen**

Cesto in filo, fodera cotone  
Drahtkorb, Baumwollfutter  
Panier métallique, doublure en coton  
Cesta de alambre, forro de algodón

art.	dim. cm.
42877-17	17x12,5x8
42877-25	25x17x12



**Kraft paper bag, washable**

Cesto pane di carta kraft lavabile  
Kraftpapierbrottasche, waschbar  
Panier en papier kraft lavable  
Cesta pan de papel kraft lavable

art.	Ø cm.	h. cm.
42879M12	12	12
42879M15	15	10
42879M22	22	13
42879M25	25	18



**Kraft paper bag, washable**

Cesto pane di carta kraft lavabile  
Kraftpapierbrottasche, waschbar  
Panier en papier kraft lavable  
Cesta pan de papel kraft lavable

art.	Ø cm.	h. cm.
42879K12	12	12
42879K15	15	10
42879K22	22	13
42879K25	25	18



**Bread basket**

Cesto pane  
Brotkorb  
Corbeille à pain  
Cesta pan

art.	Ø cm.	h. cm.
42948-18	10	7
42948-20	20	7
42948-25	25	7



**Bread basket**

Cesto pane  
Brotkorb  
Corbeille à pain  
Cesta pan

art.	dim. cm.
42948-23	23x15x6,5



**Bread basket**

Cesto pane  
Brotkorb  
Corbeille à pain  
Cesta pan

art.	Ø cm.	h. cm.
42935-19	19	9
42935-26	26	9



**Bread basket**

Cesto pane  
Brotkorb  
Corbeille à pain  
Cesta pan

art.	Ø cm.	h. cm.
42944-23	23	7



**Bread basket**

Cesto pane  
Brotkorb  
Corbeille à pain  
Cesta pan

art.	dim. cm.
42945-27	27x20x10



**Bread basket**

Cesto pane  
Brotkorb  
Corbeille à pain  
Cesta pan

art.	dim. cm.
42945-18	18x13x6,5
42945-23	23x15x6,5



**Bread basket**

Cesto pane  
Brotkorb  
Corbeille à pain  
Cesta pan

art.	Ø cm.	h. cm.	col.
42974C13	13	10	●
42974B13	13	10	●
42974M13	13	10	●
42974N13	13	10	●



**Canvas bag, round**

Cesto cotone, rotondo  
Brottasche, rund, Baumwolle  
Panier à pain rond, coton  
Cesta pan redonda, algodón

art.	Ø cm.	h. cm.
42875-17	17	8
42875-20	20	9

**Cotton, machine-washable up to 30° C.**  
Cotone, lavabile a macchina fino a 30° C.



**Canvas bag, round**

Cesto cotone, rotondo  
Brottasche, rund, Baumwolle  
Panier à pain rond, coton  
Cesta pan redonda, algodón

art.	Ø cm.	h. cm.
42875B17	17	8
42875B20	20	9

**Cotton, machine-washable up to 30° C.**  
Cotone, lavabile a macchina fino a 30° C.



**Canvas bag, oval**

Cesto cotone, ovale  
Brottasche, oval, Baumwolle  
Panier à pain ovale, coton  
Cesta pan , algodón

art.	dim. cm.
42876-20	20x15x7
42876-25	25x18x9

**Cotton, machine-washable up to 30° C.**  
Cotone, lavabile a macchina fino a 30° C.



**Canvas bag, oval**

Cesto cotone, ovale  
Brottasche, oval, Baumwolle  
Panier à pain ovale, coton  
Cesta pan , algodón

art.	dim. cm.
42876B20	20x15x7
42876B25	25x18x9

**Cotton, machine-washable up to 30° C.**  
Cotone, lavabile a macchina fino a 30° C.



**Canvas bag, round**

Cesto cotone, rotondo  
Brottasche, rund, Baumwolle  
Panier à pain, coton  
Cesta pan, algodón

art.	Ø cm.	h. cm.	col.
42873-01	20	23,5	●

**Ceramic stone pillow included. Easy to heat up in microwave for 90 sec. at 500 Watt.**  
Cuscino con sfere ceramica incluso. Scaldare in microonde per 90 secondi a 500 Watt.



W

**Bowl, oval**  
Ciotola ovale  
Schüssel, oval  
Bassine ovale  
Bol oval

art.	dim. cm.
42931-19	19,5x17



SS

**Truffle-slicer**  
Tagliatartufi  
Trüffelschneider  
Coupe-truffes  
Corta trufa

art.	dim. cm.	des.
48237-00	21x8,5	plain
48237-01	21x8,5	serrated



SS

**Truffle-slicer**  
Tagliatartufi  
Trüffelschneider  
Coupe-truffes  
Corta trufa

art.	dim. cm.	des.
48236-00	21x8,5	plain
48236-01	21x8,5	serrated

**Rosewood handle. – Manico in palissandro.**



PC

**Truffle jar**  
Contentore tartufi  
Trüffel-Verpackung  
Récipient à truffes  
Envasado para trufa

art.	Ø cm.	h. cm.
48237-99	6	4,5

**For transport and storage, prevents weight loss.**  
Per trasporto e conservazione, previene il calo di peso.



**Truffle server**  
Servitartufi  
Trüffel-Service  
Service à truffes  
Servidor de trufas

art.	dim. cm.
48237-35	30x20x9

**Chesnut wood. – Castagno.**



NEW

**Tray with dome cover**  
Vassoio con campana  
Tablett mit Haube  
Plat avec cloche  
Bandeja con campana

art.	Ø cm.	h. cm.
41416-18	18,5	24,5

**Beech wood tray with glass cover Ø 16 H 22,5 cm.**  
– Vassoio in legno di faggio con coperchio in vetro Ø 16 H 22,5 cm.



SS

**Salt/pepper shaker set**  
Set spargisale/pepe  
Salz- und Pfefferstreuer-Set  
Set salière et poivrier  
Juego salero y pimentero

art.	Ø cm.	h. cm.
42924-02	5	6,5



SS

**Condiment set, 2 pcs**  
Set 2 pz sale e pepe  
Menage, 2-teilig  
Ménagère, 2 pièces  
Servicio de mesa, 2 piezas

art.	dim. cm.
42927-02	3x3x5



**Salt/pepper shaker, chrome top**  
Spargisale/pepe cromato  
Salz-/Pfefferstreuer, verchromt  
Salière/poivrier, chromé  
Salero/pimentero, cromado

art.	ml.
42928-00	45



SS

**Salt/pepper shaker, set 12 pcs**  
Spargisale/pepe, set 12 pz  
Salz-/Pfefferstreuer, 12 Stk  
Salière/poivrier, set 12 pcs  
Salero/pimentero, juego 12 pz

art.	Ø cm.	h. cm.
42926-12	3	9



SS

**Condiment set, 2 pcs**  
Sale e pepe, 2 pezzi  
Menage, 2-teilig  
Ménagère, 2 pièces  
Servicio de mesa, 2 piezas

art.	dim. cm.
42929-01	11,5x5,5x17

**Wood base, satin polished handle.**  
Base legno, manico satinato.



SS

**Condiment set, 2 pcs**

Servizio oliera, 2 pezzi  
Menage, 2-teilig  
Ménagère, 2 pièces  
Servicio de mesa, 2 piezas

art. dim. cm.  
42929-02 16x7,5x24,5

**Wood base, satin polished handle.**  
Base legno, manico satinato.



SS

**Condiment set, 4 pcs**

Servizio oliera, 4 pezzi  
Menage, 4-teilig  
Ménagère, 4 pièces  
Servicio de mesa, 4 piezas

art. dim. cm.  
42929-03 15,5x12x24,5

**Wood base, satin polished handle.**  
Base legno, manico satinato.



SS

**Oil and winegar stand**

Porta olio/acetato  
Essig u. Öl-Stand  
Porte huile et vinaigre  
Soporte para aceite y vinagre

art. dim. cm.  
66362-02 12,5x6x27



SS

**Oil/vinegar sprayer, 2 pcs**

Nebulizzatore olio/acetato, 2 pz  
Öl-/Essigsprühflasche, 2 Stück  
Nébuliseur huile vinaigre, 2 pièces  
Nebulizador aceite/vinagre, 2 pz

art. Ø cm. h. cm. ml.  
41635-02 4 18 110



SS

**Oil and winegar stand**

Porta olio/acetato  
Essig u. Öl-Stand  
Porte huile et vinaigre  
Soporte para aceite y vinagre

art. dim. cm.  
41636-25 13x7x30



SS

**Condiment set, 4 pcs**

Servizio oliera, 4 pezzi  
Menage, 4-teilig  
Ménagère, 4 pièces  
Servicio de mesa, 4 piezas

art. dim. cm.  
41638-04 17,5x10,5x23



SS

**Condiment set, 2 pcs**

Servizio oliera, 2 pezzi  
Menage, 2-teilig  
Ménagère, 2 pièces  
Servicio de mesa, 2 piezas

art. dim. cm.  
41638-02 14,5x8,5x23



SS

**Condiment set, 2 pcs**

Sale e pepe, 2 pezzi  
Menage, 2-teilig  
Ménagère, 2 pièces  
Servicio de mesa, 2 piezas

art. dim. cm.  
41638-12 10,5x6,5x16





SS

**Condiment set, 3 pcs**  
Set sale, pepe, stecchi  
Menage, 3-teilig  
Ménagère, 3 pièces  
Servicio de mesa, 3 piezas

art.	Ø cm.	h. cm.
41638-13	10,5	16



SS

**Cheese jar**  
Formaggiera  
Käsedose  
Fromagère  
Quesera

art.	Ø cm.	h. cm.
41638-01	10,5	7



SS

**Cheese shaker**  
Spargiformaggio  
Käsestreuer  
Poudreuse à fromage  
Colteler de queso

art.	ml.
42921-00	360



PP

**Cutlery/breadstick basket**  
Portaposate/grissini  
Besteck-/Salzstangenkorb  
Panier à couverts/gressins  
Cesta cubiertos/palitos de pan

art.	Ø cm.	h. cm.
42584-01	12	15



PP

**Cutlery dispenser**  
Portaposate  
Besteck-Ablage  
Panier à couverts  
Cesta portacubiertos

art.	dim. cm.
42584-02	27x10x4,5



PP

**Cutlery dispenser**  
Portaposate  
Besteck-Ablage  
Panier à couverts  
Cesta portacubiertos

art.	dim. cm.
42584-04	53x32,5x10



PP

**Cutlery dispenser**  
Portaposate  
Besteck-Ablage  
Panier à couverts  
Cesta portacubiertos

art.	dim. cm.
42584-05	53x32,5x9



PP

**Cutlery dispenser**  
Portaposate  
Besteck-Ablage  
Panier à couverts  
Cesta portacubiertos

art.	dim. cm.	col.
42584-06	26x18x15	●
42584-07	26x18x15	●



W

**Table caddy**  
Portacondimenti  
Tisch-Caddy  
Caddy de table  
Caddy de mesa

art.	Ø cm.	h. cm.
41639-17	17,5	8,5



W

**Cutlery dispenser**  
Portaposate  
Besteck-Ablage  
Panier à couverts  
Cesta portacubiertos

art.	Ø cm.	h. cm.
41639-11	11,5	14



W

**Table caddy 4 compartments**  
Portacondimenti 4 comparti  
Tisch-Caddy 4-Fächer  
Caddy de table 4 compartiments  
Caddy de mesa 4 compartimentos

art.	dim. cm.	col.
41639-30	17x17x10	○
41639-31	17x17x10	●
41639-32	17x17x10	●

Compartments/Scomparti 7x7 cm.



W

**Table caddy 6 compartments**

Portacondimenti 6 compart

Tisch-Caddy 6-Fächer

Caddy de table 6 compartiments

Caddy de mesa 6 compartimentos

art. dim. cm. col.

41639-40 27x17x10 ○

41639-41 27x17x10 ●

41639-42 27x17x10 ●

**Compartments/Scomparti 7,5x7,5 cm.**



SS

**Table-cloth clips, 4 pcs set**

Fermatovaglia, set 4 pz

Tischtuch Klammer, 4 Stk

Pinces à nappe, 4 pièces

Pinzas para mantel, 4 piezas

art.

42953-04

**For table/Per tavoli h 3 cm.**



SS

**Napkin holder**

Legatovagliolo

Serviettenring

Porteserviette

Servilletero

art.

42955-00



SS

**Dome cover**

Cloche

Speiseglocke

Cloche

Cubreplatos

art. Ø cm. h. cm.

41560-28 29 18



SS

ABS

**Pocket crumbler**

Raccoglibriciole tascabile

Krümelsammler taschenformat

Ramasse miettes de poche

Recogemigas de bolsillo

art. dim. cm.

42593-00 14x2,7



SS

**Table crumbler**

Raccoglibriciole a tubo

Krümelsammler

Ramasse miettes

Pala recogemigas

art. dim. cm.

41679-23 23,5



**Raclette maker, 4 pans**

Macchina per raclette, 4 padelle

Raclette Tischgerät, 4 Pfannen

Appareil à raclette, 4 poêlons

Máquina raclette

art. dim. cm. W

41318-00 51x10x12 600

**Non-stick upper plate for all cooking (vegetables, meats, etc.). – Piastra superiore antiaderente per tutte le cotture (verdure, carne, ecc.).**



**Raclette maker**

Macchina per raclette  
Raclette Tischgerät  
Appareil à raclette  
Máquina raclette

art.	dim. cm.	W
42420-06	44,5x21,5x30	850

**Foldable model with transport hook. 2 heating ramps, adjustable height. Suitable for cheese size 1/6 to 1/3 of a wheel. In stainless steel and painted steel.** – Modello pieghevole con gancio di trasporto. 2 rampe di riscaldamento, altezza regolabile. Adatto per formaggi da 1/6 a 1/3 di una forma. In acciaio inossidabile e acciaio verniciato.



**Raclette maker**

Macchina per raclette  
Raclette Tischgerät  
Appareil à raclette  
Máquina raclette

art.	dim. cm.	W
42420-08	46x26,5x40	850

**Tilttable and easily removable cheese holder. Heating block adjustable height. Ideal for 6-8 people, 1/2 shape. Cheese holder in stainless steel and epoxy painted steel structure.** – Porta formaggio inclinabile e facilmente rimovibile. Blocco riscaldante regolabile in altezza. Ideale per 6-8 persone, 1/2 forma. Porta formaggio in acciaio inossidabile e struttura in acciaio verniciato epossidico.



**Fondue set, copper**

Set fonduta, rame  
Fondue-Service, Kupfer  
Service à fondue, cuivre  
Servicio para fondues, cobre

art.	Ø cm.	h. cm.
15430-11	16	26



**Cheese fondue set**

Set fonduta formaggio  
Käsefondue-Service  
Service à fondue fromage  
Servicio para fondues queso

art.	Ø cm.	h. cm.
41311-00	20	18



**Bourguignonne fondue set**

Set fonduta bourguignonne  
Bourguignonefondue-Service  
Service à fondue bourguignonne  
Servicio para fondues bourguignonne

art.	Ø cm.	h. cm.
41312-00	20	18



**Dipping forks, 6 pcs**

Set forchette, 6 pz  
Fonduegabeln, 6 Stk  
Curettes à fondue, 6 pièces  
Tenedores para fondue, 6 pz

art.	l. cm.
15428-06	24



**Stand with grill stone**

Supporto con pietra ollare  
Träger mit Kochstein  
Pierre à cuire avec support  
Soporte con piedra

art.	dim. cm.
41315-02	17x20x12

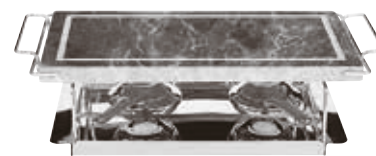

**Stand with grill stone**

Supporto con pietra ollare  
Träger mit Kochstein  
Pierre à cuire avec support  
Soporte con piedra

art.	dim. cm.
41315-04	44x20x12



SS

**Table barbecue, 1 closed side**

Barbecue da tavola, da esterno  
Tischgrill, 1 geschlossene Seite  
Barbecue de table 1 foyer fermé  
Barbacoa de mesa, 1 lado cerrado

art. dim. cm. Kg.

41313-00 33x22x20 7,3

**Also for outdoor use. Solid beech board. Can be put in the dishwasher once disassembled.**

Anche per uso all'esterno. Tagliere in faggio massiccio. Può essere lavato in lavastoviglie una volta smontato.



SS

**Table barbecue, 2 open sides**

Barbecue da tavola, da interno  
Tischgrill, 2 offene Seiten  
Barbecue de table 2 foyers ouverts  
Barbacoa de mesa, 2 lados abiertos

art. dim. cm. Kg.

41314-00 33x22x20 7,3

**2 open sides for indoor use. Solid beech board. Can be put in the dishwasher once disassembled.**

**Supplied with 1 steel pan Ø cm 18 and 1 spatula**  
2 lati aperti per uso interno. Tagliere in faggio massiccio. Può essere lavato in lavastoviglie una volta smontato. Fornito con 1 padella di ferro Ø cm 18 e 1 spatola.



SS

**Plate warmer**

Rechaud  
Speisenwärmer  
Chauffe-plats  
Calentador de platos

art. Ø cm. h. cm.

41317-20 20 11

**Burning time 2 hours with an average flame.**  
Tempo di combustione 2 ore a fiamma media.



SS

**Plate warmer**

Rechaud  
Speisenwärmer  
Chauffe-plats  
Calentador de platos

art. dim. cm.

41569-33 33x18x6,5

**Aluminum plate. – Piastra in alluminio.**



**Mussel pot, enamel cast-iron**

Cocotte per molluschi, ferro smaltato  
Muscheltopf, emaillierts Stahlblech  
Casserole coquillage, émaillée  
Cacerola para mejillones, esmaltada

art. Ø cm. h. cm. lt.

42414-05 13,5 9,0 0,8

42414-10 18,0 12,0 2,0

42414-15 20,0 13,0 3,0

42414-20 24,0 13,5 4,0



**Trivet, cork**

Sottopentola, sughero  
Korkuntersetzer  
Sous-plat, liège  
Posavasos de corcho

art. Ø cm.

42413-24 24



SS

**Stand with 4 skewers**

Supporto con 4 spiedini  
Träger mit 4 Fleischspiesen  
Support avec 4 brochettes  
Soporte con 4 brochetas

art. Ø cm. h. cm.

42417-22 22 46





SAN

**Swing table top waste bin**

Portarifiuti da tavola  
Tischeimer  
Poubelle dé table  
Papelera sobremesa, plástico

art. Ø cm. h. cm.  
42959-13 12 18



SS

**Swing table top waste bin**

Portarifiuti da tavola  
Tischeimer  
Poubelle dé table  
Papelera sobremesa

art. Ø cm. h. cm.  
42959-12 12 17



**Nut-cracker**

Schiaccianoci  
Nussknacker  
Casse-noix  
Cascanueces

art.  
48211-00



SS

**Nut-cracker**

Schiaccianoci  
Nussknacker  
Casse-noix  
Cascanueces

art. l. cm.  
48210-00 15,3



SS

**Lobster cracker**

Pinza aragosta  
Hummerzange  
Pince à homard  
Pinza bogavante

art. l. cm.  
48239-00 20



**Lobster cracker, aluminum**

Pinza aragosta, alluminio  
Hummerzange, Aluminum  
Pince à homard, alu  
Pinza bogavante, alluminio

art. dim. cm.  
48240-00 14,5x6,5



SS

**Sea urchin cutter**

Taglia ricci di mare  
Seeigel-Messer  
Coupe oursin  
Cortador de erizo de mar

art. dim. cm.  
48286-68 6x22



SS

**Lobster pick**

Stiletto aragosta  
Hummergabel  
Curette à homard  
Tenedor bogavante

art. l. cm.  
48238-00 20



SS

**Lobster forks**

Forchettine per aragosta  
Hummergäbelchen  
Curettes à homard  
Tenedores bogavante

art. dim. cm. U. Pack  
41594-18 18 5



SS

**Picks, set 12 pcs**

Spilloncini, set 12 pz  
Stocher, 12 Stk.  
Pic-bigorneaux, set 12 pcs  
Pico-caracoles, juego 12 pz

art.  
41594-12



SS

**Escargot picks, chromed, set 12 pcs**

Forchettine lumache, cromate, set 12 pz  
Schnecken-gabel, verchromed, 12 Stk.  
Pic-escargots, chromés, set 12 pcs  
Pico-caracoles, cromados, juego 12 pz

art. l. cm.  
41686-12 8



SS

**Escargot dish**

Piatto lumache  
Schneckenplatte  
Plat à escargots  
Plato caracoles

art. Ø cm. comp.  
41687-06 15,5/17,5 6  
41687-12 19/22,5 12



SS

**Caviar cooler**

Coppa caviale  
Kaviarkühler  
Rafraîchisseur à caviar  
Copa caviar

art.	Ø cm.	h. cm.
41562-18	18	5



**Caviar flatware, mother of pearl**

Posate caviale, madreperla  
Kaviar-Bestecke, Perlmuttern  
Couverts à caviar, nacre  
Cuberteria caviar, nácar

art.	dim. cm.	des.
41518-00	10	spoon
41518-01	10	knife
41518-02	10	fork



SS

**Oyster tray**

Vassoio frutti di mare  
Austernplatte  
Plat à huîtres  
Fuente de mariscos

art.	Ø cm.	h. cm.
41592-36	36	4,0
41592-45	45	5,5



SS

**Oyster tray**

Vassoio frutti di mare  
Austernplatte  
Plat à huîtres  
Fuente de mariscos

art.	Ø cm.
41591-90	45-36



**Seafood display rack, chromed**

Supporto acciaio cromato  
Unterteil für Austernplatte, verchromt  
Support en fil chromé  
Soporte cromado para fuente mariscos

art.	Ø cm.	h. cm.
41593-20	19-25	20



**Oyster tray, aluminum**

Vassoio frutti di mare, alluminio  
Austernplatte, Aluminum  
Plat à huîtres, alu  
Fuente de mariscos, aluminio

art.	Ø cm.	h. cm.
41591-32	32	6
41591-36	36	6
41591-40	40	6
41591-45	45	6



SS

**Oyster/fruit stand**

Alzata Royale  
Austern-/Obstständer  
Etagère Royale  
Expositor de mariscos/frutas

art.	Ø cm.	h. cm.
41820-03	24-33-42	50





SS

**Table bag holder**  
Gancio appendi borsa  
Handtaschentischhänger  
Crochet de table  
Colgador de bolso  
art.  
41559-04



**Wine bucket table clip, chrome**  
Supporto secchio vino tavola, cromato  
Weinkühler-Tischbefestigung, verchromt  
Porte-seau à vin, chromé  
Soporte de mesa cubo vino, cromado  
art.  
41558-00

Per/For: 41501-20, 41502-20.



SS

**Wine bucket**  
Secchiello vino  
Weinkühler  
Seau à vin  
Cubo vino  
art.      Ø cm.    h. cm.  
41502-20    20      20



**Wine bucket, aluminum**  
Secchiello vino, alluminio  
Weinkühler, Aluminium  
Seau à vin, alu  
Cubo vino, aluminio  
art.      Ø cm.    h. cm.  
41501-20    20      21



SS

**Wine cooler**  
Secchiello vino  
Weinkühler  
Seau à vin  
Cubo vino  
art.      Ø cm.    h. cm.    bot.  
46120-18    17,0    16      1/2  
46120-22    21,5    21      1  
46120-24    24,0    22      2



SS

**White wine cooler**  
Secchio vino bianco  
Weissweinkühler  
Seau à vin blanc  
Cubo vino blanco  
art.      Ø cm.    h. cm.  
46118-20    20      25



SS

**Wine cooler stand**  
Colonna portasecchiello  
Ständer für Weinkühler  
Support seau à champagne  
Soporte para cubo  
art.      Ø cm.    h. cm.  
41505-20    20      70,5



SS

**Wine cooler stand**  
Colonna portasecchiello  
Ständer für Weinkühler  
Support seau à champagne  
Soporte para cubo  
art.      Ø cm.    h. cm.  
41505-17    17,5    64  
41505-19    19,5    64



SS

**Bottle cooler**  
Glacette termica  
Flaschenkühler  
Rafraichisseur à bouteille  
Enfriador isotémico  
art.      Ø cm.    h. cm.  
41508C12    12/10    20



**Bottle cooler, concrete**  
Glacette, cemento  
Flaschenkühler, Beton  
Rafraîchisseur à bouteille, béton  
Enfriador, cemento

art. Ø cm. h. cm.  
41504-19 12/10 19



**Bottle cooler**  
Glacette termica  
Flaschenkühler  
Rafraîchisseur à bouteille  
Enfriador isotérmico

art. Ø cm. h. cm.  
41504-09 9,5 22,5



**Bottle cooler**  
Glacette termica  
Flaschenkühler  
Rafraîchisseur à bouteille  
Enfriador isotérmico

art. Ø cm. h. cm.  
41504-10 10 21



**Bottle cooler**  
Glacette termica  
Flaschenkühler  
Rafraîchisseur à bouteille  
Enfriador isotérmico

art. Ø cm. h. cm.  
41508-10 10 30



**Bottle cooler**  
Glacette termica  
Flaschenkühler  
Rafraîchisseur à bouteille  
Enfriador isotérmico

art. Ø cm. h. cm.  
41504-12 12,5/10 22



**Bottle cooler**  
Glacette termica  
Flaschenkühler  
Rafraîchisseur à bouteille  
Enfriador isotérmico

art. Ø cm. h. cm.  
41504-11 10 22



**Bottle cooler**  
Glacette termica  
Flaschenkühler  
Rafraîchisseur à bouteille  
Enfriador isotérmico

art. Ø cm. h. cm.  
41507-01 11,5/9,5 23



**Wine holder**  
Versavino a molla  
Weingestell  
Porte-Bouteille  
Soporte para botella

art. Ø cm.  
41510-08 8



**Wine holder**  
Versavino reversibile  
Weingestell  
Porte-Bouteille  
Soporte para botella

art. l. cm.  
46123-00 17





**Wine collar, chromed**

Collare salvagoccia, cromato  
Tropfenfänger, verchromt  
Collier anti-gouttes, chromé  
Anillo anti-goteo, cromado

art.

41511-00



**Wine taster with ring and cord**

Tastevin con anello e cordino  
Weinprobenschale mit Ring und Schnur  
Tastevin avec anneau et cordon  
Catador del vino con anillo y cordón

art. Ø cm.

41499-08 8,5

SS



**Cognac warmer, palladium**

Scaldacognac, palladio  
Cognacwärmer, Palladium  
Réchaud à cognac, palladium  
Calentador brandy, paladio

art. h. cm.

41678-14 14,5



**Champagne saber**

Sciabola per Sommelier  
Champagnersäbel  
Sabra à champagne  
Sable para Champán

art. l. cm.

41496-40 40



**Champagne tongs, chromed**

Pinza champagne, cromata  
Champagner-Zange, verchromed  
Pince à champagne, chromée  
Pinza Champaña, cromada

art.

41511-30



**Pourer**

Versatore  
Ausgießer  
Verseur  
Vertedor

art.

41511-20

SS



**Flower vase, nickel plated**

Vaso fiori, nichelato  
Blumenvase, vernickelt  
Vase à fleurs, nickelé  
Florero, zinc-niquel

art. Ø cm. h. cm.

42942-16 4 16,5



**Flower vase**

Vaso fiori  
Blumenvase  
Vase à fleurs  
Florero

art. h. cm.

41628-15 15

SS



**Candlestick**

Candelieri  
Kerzenleuchter  
Chandelier  
Candelabro una vela

art. Ø cm. h. cm.

32931-02 10 20,5

AG



**Candelabra 3 lights**

Candelabro 3 luci  
Kerzenleuchter, 3-flammig  
Chandelier, 3 branches  
Candelabro, 3 brazos

art. Ø cm. h. cm.

32931-03 10 22,5

AG



**Candelabra 5 lights**

Candelabro 5 luci  
Kerzenleuchter, 5-flammig  
Chandelier, 5 branches  
Candelabro, 5 brazos

art. Ø cm. h. cm.

32931-05 10 24

AG



AG

**Candlestick**

Candeliere  
Kerzenleuchter  
Chandelier

Candelabro una vela

art.	Ø cm.	h. cm.
32935-10	10	10
32935-22	10	22



**Candelabra 5 lights, nickel-plated**

Candelabro 5 luci, nichelato  
Kerzenleuchter, 5-flammig, vernickelt  
Chandelier, 5 branches, nickelé  
Candelabro, 5 brazos, niquelado

art.	Ø cm.	h. cm.
42443-06	17	56
42443-08	24	78



AG

**Candelabra 3 lights**

Candelabro 3 luci  
Kerzenleuchter, 3-flammig  
Chandelier, 3 branches  
Candelabro, 3 brazos

art.	Ø cm.	h. cm.
32935-03	11	25



AG

**Candelabra 5 lights**

Candelabro 5 luci  
Kerzenleuchter, 5-flammig  
Chandelier, 5 branches  
Candelabro, 5 brazos

art.	Ø cm.	h. cm.
32935-05	11	25



AG

**Candelabra 3 lights**

Candelabro 3 luci  
Kerzenleuchter, 3-flammig  
Chandelier, 3 branches  
Candelabro, 3 brazos

art.	Ø cm.	h. cm.
32936-03	13	39



AG

**Candelabra 5 lights**

Candelabro 5 luci  
Kerzenleuchter, 5-flammig  
Chandelier, 5 branches  
Candelabro, 5 brazos

art.	Ø cm.	h. cm.
32936-05	13	39



SS

**Candleholder satin finish, set 2 pcs**

Portacandela satinato, set 2 pz  
Windlicht, mattiert, 2er Set  
Bougeoir satin mat, set 2 pcs  
Portavela satinado, set 2 pz

art.	Ø cm.	h. cm.
42939-15	5	15



**Candleholder, chromed**

Portacandela, cromato  
Windlicht, verchromt  
Bougeoir, chromé  
Portavela, cromado

art.	Ø cm.	h. cm.
42941-22	11	22





**Set 4 tea light candles**

Set 4 candele tea light  
Kunstteelichter, 4er Set  
Set 4 bougies chauffeplat  
Set 4 velas de tè

art. Ø cm. h. cm.

42446-04 3,65 3,53

**Resin. Timer function 5 hours ON/19 OFF. Powered by one CR2450 alkaline battery (not incl.). Working time >50 hours. Flameless moving wick.** – Resina. Funzione timer 5 ore ON/19 OFF. 1 batteria alcalina CR2450 (non incl.). Durata > 50 ore. Stoppino mobile senza fiamma.



**Set 3 candele**

Set 3 candles  
Kunstkerzen, 3er Set  
Set 3 bougies  
Set 3 velas

art. Ø cm. h. cm.

42445-03 9 12,5  
9 18,0  
9 23,0

**Resin. Timer function 5 hours ON/19 OFF. Powered by 2D alkaline batteries (not incl.). Working time >800 hours. Flameless moving wick.** – Resina. Funzione timer 5 ore ON/19 OFF. 2 batterie alcaline D (non include). Durata > 800 ore. Stoppino mobile senza fiamma.



**Sign holders, chromed**

Clip flessibili, cromate  
Schildhalter, verchromt  
Porte-étiquettes, chromés  
Porta etichetas con clip, cromate

art. l. cm. pcs/pz

41394-02 12 2



**Menu stand**

Porta menù  
Speisekartenhalter  
Porte-menu  
Portamenús

art. dim. cm.

42951-08 8x7x2



**Table number stand, 4 pcs set**

Supporto numero tavola, set 4 pz  
Tischnummerständer, Satz 4 Stk  
Support numéro de table, set 4 pcs  
Soporte número de mesa, set 4 pz

art. Ø cm. h. cm.

42954-04 4 10



**Table number stand**

Supporto numero tavola  
Tischnummerständer  
Support numéro de table  
Soporte número de mesa

art. Ø cm. h. cm.

42954-18 7,5 18,5  
42954-29 7,5 29,0  
42954-46 7,5 46,0



**Card holder**

Supporto targhetta  
Kartenhalter  
Porte-cartes  
Portatarjetas

art. dim. cm.

42952-05 6x5x3



**Table sign, 2 pcs set**

Targhetta tavola, set 2 pz  
Tischaufsteller, Satz 2 Stk  
Plaque de table, set 2 pcs  
Placa de mesa, set 2 pz

art. dim. cm.

42951-57 5,5x5x3,5



**Table sign, 2 pcs set**

Targhetta tavola, set 2 pz  
Tischaufsteller, Satz 2 Stk  
Plaque de table, set 2 pcs  
Placa de mesa, set 2 pz

art. dim. cm.

42951-59 5,5x5x3,5



SS

**Reception bell**

Campanella reception  
Receptionsschell  
Sonette de réception  
Timbre recepción

art.	Ø cm.	h. cm.
41390-00	8,5	6



W

**Newspaper stick**

Portagiornale  
Zeitungshalter  
Canne à journaux  
Varilla portaperiodico

art.	l. cm.	col.
48287-18	75	○
48287-19	75	●



**Chalkmarker**

Penna a gesso liquido  
Kreidestifte  
Stylo à craie liquide  
Rotulador de tiza líquida

art.	Ø mm.	col.
47832-00	5	○
47832-01	5	●
47832-02	5	●
47832-03	5	●
47832-04	5	●
47832-05	5	●

**Clean with water. Writes on all non porous surfaces. – Pulire con acqua. Scrive su tutte le superfici non porose.**



**Chalkmarker**

Penna a gesso liquido  
Kreidestifte  
Stylo à craie liquide  
Rotulador de tiza líquida

art.	Ø mm.	col.
47832-10	15	○
47832-11	15	●
47832-12	15	●
47832-13	15	●
47832-14	15	●
47832-15	15	●



NEW

**Sandwich board**

Lavagna cavalletto bifacciale  
Gehwegtafel  
Tableau chevalet 2 faces  
Pizarra en ángulo

art.	dim. cm.	h. cm.
44185-50	50x72	85
44185-70	69x100	120

**MDF surface with wooden frame.**  
Lavagna in MDF con cornice in legno.



NEW

**Wall board**

Lavagna da muro  
Wandtafel  
Tableau mural  
Pizarra murale

art.	dim. cm.
44187-40	40x60
44187-60	60x80

**MDF surface. – Lavagna in MDF.**







**Ashtray**  
Posacenere  
Aschenbecher  
Cendrier  
Cenicero

art.	Ø cm.
48247-10	10



**Ashtray**  
Posacenere  
Aschenbecher  
Cendrier  
Cenicero

art.	Ø cm.	h. cm.
48250-10	10	4,5
48250-12	12	4,5



**Ashtray**  
Posacenere  
Aschenbecher  
Cendrier  
Cenicero

art.	Ø cm.
44366-10	10



**Ashtray, chrome plated**  
Posacenere, cromato  
Aschenbecher, Metall hartverchromt  
Cendrier, chromé  
Cenicero, cromado

art.	Ø cm.	h. cm.
48249-13	13	10,5



**Ashtray, 3 pcs set**  
Posacenere, set 3 pz  
Aschenbecher, 3 Stk  
Cendrier, set 3 pièces  
Cenicero, 3 pz

art.	Ø cm.	h. cm.	col.
48251-03	8	3	●



**Ashtray**  
Posacenere  
Aschenbecher  
Cendrier  
Cenicero

art.	Ø cm.	h. cm.	col.
48253B09	9,5	4,5	●



**Ashtray**  
Posacenere  
Aschenbecher  
Cendrier  
Cenicero

art.	Ø cm.	h. cm.	col.
48253-09	9,5	4,5	○



**Ashtray**  
Posacenere  
Aschenbecher  
Cendrier  
Cenicero

art.	Ø cm.	h. cm.	col.
48252-10	10	4,0	○
48252-12	12	4,5	○



**Ashtray**  
Posacenere  
Aschenbecher  
Cendrier  
Cenicero

art.	Ø cm.	h. cm.	col.
48252B10	10	4,0	●
48252B12	12	4,5	●



**Table cigar cutter**  
Tagliasigari da tavola  
Zigarrenschneider  
Coupe-cigares  
Guillotina para puros

art.	dim. cm.
48244-07	9x4



**Table cigar cutter**  
Tagliasigari da tavola  
Zigarrenschneider  
Coupe-cigares  
Guillotina para puros

art.	dim. cm.
48244-04	4x4



**Table cigar cutter**  
Tagliasigari da tavola  
Zigarrenschneider  
Coupe-cigares  
Guillotina para puros

art.	dim. cm.
48242-09	9x4

Double blad. Assorted models. – Doppia lama.  
Modelli assortiti.



SS

**Cigar scissors**

Forbice sigari  
Zigarrenscher  
Ciseaux à cigares  
Cortador para puros

art.	dim. cm.
48245-10	10x5



PAMMA

W

**Cigar humidor**

Vetrina sigari  
Zigarren-Vitrine  
Vitrine à cigares  
Vitrina para puros

art.	dim. cm.
48245-75	30x24x13

**With an incorporated hygrometre a small humidifier and liquid. Plexiglass window, cedar wood interior with two removable dividers. Can contain between 50 and 70 cigars according to the cigar ring. – Dotato di igrometro incorporato e un piccolo umidificatore oltre al liquido. Finestra in plexiglass interno di cedro con due divisori removibili. Capienza da 50 a 75 sigari in relazione al ring del sigaro.**



SS

**Cigar ashtray**

Portasigaro con piattino  
Aschenbecher mit Zigarrenhalter  
Cendrier à cigares  
Cenicero para puros

art.	Ø cm.
48241-14	14,5



# PEUGEOT MILLS MACINE



TABLE TOP  
TAVOLA





MECHANISMS  
MECCANISMI



PEPPER



SALT



WET SEA SALT



LONG PEPPER



CHILI PEPPER



NUTMEG



CINNAMON



FLAX SEED

**PEPPER**

Made of case-hardened steel for higher, more consistent output with fewer turns. Equipped with a helix-shaped double row of teeth that guide and hold the peppercorns for a perfect grind. The grind is essential for unlocking the full flavour of your pepper. To get the best out of your pepper grinding mechanism, we recommend to use peppercorns with a diameter of 6 mm or less. Black, white and dry green peppercorns can be ground in Peugeot pepper mills. The pink berries can be ground only if in a blend (max 15% pink) with one of these peppercorns. Dried coriander is also suitable for the pepper mechanism.

**DRY SALT**

The Peugeot salt mechanism is designed to grind cooking salt (rock salt). It is made of a special stainless steel that resists corrosion. Its shape is specifically adapted to transform dry salt crystals to a fine powder. To get the best out of your Peugeot salt grinding mechanism, you should use salt with a size of 4 mm max.

**WET SEA SALT**

For wet sea salt, a specially designed mechanism has been created because the natural consistency and moisture content do not allow the use of an ordinary salt mill. An innovative patented system enables a high-performance grind without blockage even with very humid or compressed salt. This specific mechanism is composed of 3 fins ensuring both resistance and constant output, and of an spiral that mixes the salt and guides it, ensuring a constant flow. Exclusive ceramic mechanism.

**NUTMEG**

The Peugeot nutmeg mill is equipped with a double stainless steel blade/grater and a strong claw which enables the nutmeg to be very finely ground.

**CHILI PEPPER**

The chili pepper mechanism is a Peugeot exclusive product. This patented model has a pre-cutting system and a mechanism that grinds dry chili pepper. Like the pepper grinder it has a patented treatment that protects the steel from corrosion while maintaining its sharpness and wear resistance.

**PEPE**

Realizzato in acciaio, beneficia di un trattamento che lo protegge dalla corrosione, conserva il potere tranciante e lo rende resistente all'usura. Dotato di una doppia fila di denti elicoidali che guidano i grani di pepe verso il basso. Trancia e non schiaccia i grani, per sprigionarne sottilmente sapore e profumo. Consigliamo di utilizzare grani di pepe con un diametro di 6 mm o meno. I grani di pepe neri, bianchi e verdi secchi possono essere macinati nei macinapepe Peugeot. Le bacche rosa possono essere macinate solo se in miscela (max 15% rosa). Il meccanismo del pepe è adatto anche al coriandolo essiccato.

**SALE SECCO**

Il meccanismo del sale è progettato per macinare il sale da cucina (sale grosso). È fatto di un speciale acciaio inossidabile resistente alla corrosione. La sua forma è specificamente adattata per trasformare cristalli di sale secco in una polvere fine. Per un risultato ottimale si consiglia di usare sale con una dimensione di 4 mm max.

**SALE MARINO UMIDO**

Per il sale marino umido, è stato creato un meccanismo apposito. Un innovativo sistema brevettato consente una macinatura ad alte prestazioni senza ostruzioni anche con sale molto umido o compresso. Il meccanismo è composto da 3 alette che ne garantiscono sia la resistenza sia un rendimento costante, e di una spirale che mescola il sale e lo guida assicurandone un flusso costante. Meccanismo esclusivo in ceramica.

**NOCE MOSCATA**

La macina è dotata di una doppia lama per grattugiare in acciaio inox e di un robusto dischetto uncinato che permette di grattugiare l'intera noce molto finemente.

**PEPERONCINO**

Questo meccanismo è un prodotto esclusivo Peugeot. Il modello brevettato ha un sistema di pre-taglio e un meccanismo che permettono di macinare il peperoncino essiccato. Come il macinapepe, il meccanismo subisce un trattamento brevettato che protegge l'acciaio dalla corrosione pur mantenendo la sua affilatura e resistenza all'usura.

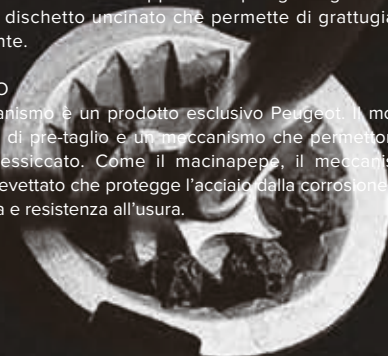





**ADJUSTABLE GRINDING SYSTEM**

For electric or manual mills.

Patented precision system that enables precise grind adjustment settings. 6 pre-defined levels of grind for pepper and 6 for salt. Rotate the ring at the base of the mill and select one of the positions, each corresponding to a specific grain.

**REGOLAZIONE DELLA MACINA**

Per macine manuali ed elettriche.

Sistema brevettato che permette una regolazione predefinita della macinatura. 6 Livelli per il pepe e 6 Livelli per il sale. Ruotare l'anello alla base della macina e selezionare una delle posizioni, ognuna corrisponde ad una determinata grana.



**CLASSIC ADJUSTABLE SYSTEM**

Thumbwheel grind adjustment on electric grinders is found below the grinding mechanism. Grind adjustment nut on manual mills, turn the nut. Clockwise to obtain a finer grind, counter-clockwise to obtain a coarser grind.

**REGOLAZIONE CLASSICA**

Negli apparecchi elettrici la rotella di regolazione si trova sotto il meccanismo di macinatura. Negli apparecchi manuali la regolazione si effettua ruotando il dado/pomolino. Ruotare in senso orario per ottenere una macinatura più fine, in senso antiorario per ottenere una macinatura più grossa.



PEPPER

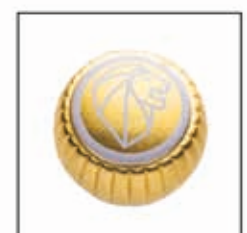

SALT





W

SS

SELECT  
MOUTURE SUR MESURE

**PARIS ICÔNE Pepper/salt mill**

Macina pepe/sale  
Pfeffer-/Salzmühle  
Moulin à poivre/sel  
Molinillo pimienta/sal

art.-P	art.-S	h. cm.
42687P18	42687S18	18
42687P22	42687S22	22

**Walnut. – Noce**



W

SS

SELECT  
MOUTURE SUR MESURE

**PARIS ICÔNE Pepper/salt mill**

Macina pepe/sale  
Pfeffer-/Salzmühle  
Moulin à poivre/sel  
Molinillo pimienta/sal

art.-P	art.-S	h. cm.
42688P18	42688S18	18
42688P22	42688S22	22
42688P30	42688S30	30

**Laquered black. – Laccato nero.**



W

**PARIS ANTIQUE Pepper/salt mill**

Macina pepe/sale  
Pfeffer-/Salzmühle  
Moulin à poivre/sel  
Molinillo pimienta/sal

art.-P	art.-S	h. cm.
42749P18	42749S18	18
42749P22	42749S22	22

**Beech wood antique. – Faggio anticato.**



W

SELECT  
MOUTURE SUR MESURE

**PARIS Pepper/salt mill**

Macina pepe/sale  
Pfeffer-/Salzmühle  
Moulin à poivre/sel  
Molinillo pimienta/sal

art.-P	art.-S	h. cm.
42665P12	42665S12	12
42665P18	42665S18	18
42665P22	42665S22	22
42665P30	42665S30	30
42665P40	42665S40	40

**Beech wood, natural. – Faggio naturale.**





W

**PARIS Pepper/salt mill**  
Macina pepe/sale  
Pfeffer-/Salzmühle  
Moulin à poivre/sel  
Molinillo pimienta/sal

art.-P	art.-S	h. cm.
42746P12	-	12
42746P18	42746S18	18
42746P22	42746S22	22
42746P30	42746S30	30

**Beech wood, chocolate.** – Faggio cioccolato.



W

**PARIS Pepper/salt mill**  
Macina pepe/sale  
Pfeffer-/Salzmühle  
Moulin à poivre/sel  
Molinillo pimienta/sal

art.-P	art.-S	h. cm.
42746P40	-	40
42746P50	-	50
42746P80	-	80

**Beech wood, chocolate.** – Faggio cioccolato.



W

**PARIS Pepper/salt mill**  
Macina pepe/sale  
Pfeffer-/Salzmühle  
Moulin à poivre/sel  
Molinillo pimienta/sal

art.-P	art.-S	h. cm.
42747P12	42747S12	12
42747P18	42747S18	18

**Beech wood, black lacquered.**  
Faggio laccato nero.





NEW  
W

**PARIS OLIVE Pepper/salt mill**

Macina pepe/sale  
Pfeffer-/Salzmühle  
Moulin à poivre/sel  
Molinillo pimienta/sal

art.-P	art.-S	h. cm.
42718P18	42718S18	18
42718P22	42718S22	22

Olive wood. – Ulivo.



W  
SELECT  
MOUTURE SUR MESURE

**PARIS Pepper/salt mill**

Macina pepe/sale  
Pfeffer-/Salzmühle  
Moulin à poivre/sel  
Molinillo pimienta/sal

art.-P	art.-S	h. cm.
42666P12	42666S12	12
42666P18	42666S18	18
42666P22	42666S22	22
42666P27	42666S27	27
42666P30	42666S30	30
42666P40	42666S40	40

Beech wood, chocolate. – Faggio cioccolato.



W  
SELECT  
MOUTURE SUR MESURE

**PARIS Pepper/salt mill**

Macina pepe/sale  
Pfeffer-/Salzmühle  
Moulin à poivre/sel  
Molinillo pimienta/sal

art.-P	art.-S	h. cm.
42668P12	42668S12	12
42668P18	42668S18	18
42668P22	42668S22	22
42668P30	42668S30	30
42668P40	-	40

Beech wood, red lacquered.  
Faggio laccato rosso.





**PARIS GRAPHITE Pepper/salt mill**

Macina pepe/sale  
Pfeffer-/Salzmühle  
Moulin à poivre/sel  
Molinillo pimienta/sal

art.-P	art.-S	h. cm.
42721P18	42721S18	18
42721P22	42721S22	22
42721P30	42721S30	30

**Beech wood graphite.** – Faggio grafite.



**PARIS Pepper/salt mill**

Macina pepe/sale  
Pfeffer-/Salzmühle  
Moulin à poivre/sel  
Molinillo pimienta/sal

art.-P	art.-S	h. cm.
42667P12	42667S12	12
42667P18	42667S18	18
42667P22	42667S22	22
42667P30	42667S30	30

**Beech wood, black lacquered.**  
Faggio laccato nero.



**PARIS Pepper/salt mill**

Macina pepe/sale  
Pfeffer-/Salzmühle  
Moulin à poivre/sel  
Molinillo pimienta/sal

art.-P	art.-S	h. cm.
42664P12	42664S12	12
42664P18	42664S18	18
42664P22	42664S22	22
42664P30	42664S30	30
42664P40	-	40

**Beech wood, white lacquered.**  
Faggio laccato bianco.



**PARIS CHEF Pepper/salt mill**

Macina pepe/sale  
Pfeffer-/Salzmühle  
Moulin à poivre/sel  
Molinillo pimienta/sal

art.-P	art.-S	h. cm.
42674P18	42674S18	18
42674P22	42674S22	22
42674P30	42674S30	30



**BISTRO CHEF Pepper/salt mill**

Macina pepe/sale  
Pfeffer-/Salzmühle  
Moulin à poivre/sel  
Molinillo pimienta/sal

art.-P	art.-S	h. cm.
42624P10	42624S10	10



**BISTRO Pepper/salt mill**

Macina pepe/sale  
Pfeffer-/Salzmühle  
Moulin à poivre/sel  
Molinillo pimienta/sal

art.-P	art.-S	h. cm.
42701-10	42703-10	10

**Beech wood, natural.** – Faggio naturale.



**BISTRO Pepper/salt mill**

Macina pepe/sale  
Pfeffer-/Salzmühle  
Moulin à poivre/sel  
Molinillo pimienta/sal

art.-P	art.-S	h. cm.
42701P10	42703S10	10

**Beech wood, white matt.** – Faggio bianco opaco.





W

**BISTRO Pepper/salt mill**

Macina pepe/sale  
Pfeffer-/Salzmühle  
Moulin à poivre/sel  
Molinillo pimienta/sal

art.-P art.-S h. cm.  
42702-10 42704-10 10

**Beech wood, chocolate.** – Faggio cioccolato.



W

**BISTRO Pepper/salt mill**

Macina pepe/sale  
Pfeffer-/Salzmühle  
Moulin à poivre/sel  
Molinillo pimienta/sal

art.-P art.-S h. cm.  
42702P10 42704S10 10

**Beech wood, black matt.** – Faggio nero opaco.



W

**BISTRO ANTIQUE Pepper/salt mill**

Macina pepe/sale  
Pfeffer-/Salzmühle  
Moulin à poivre/sel  
Molinillo pimienta/sal

art.-P art.-S h. cm.  
42705P10 42705S10 10

**Beech wood antique.** – Faggio anticato.



NEW

W

**BISTRO GRAPHITE Pepper/salt mill**

Macina pepe/sale  
Pfeffer-/Salzmühle  
Moulin à poivre/sel  
Molinillo pimienta/sal

art.-P art.-S h. cm.  
42713P10 42713S10 10

**Beech wood graphite.** – Faggio grafite.



NEW

W

**BISTRO OLIVE Pepper/salt mill**

Macina pepe/sale  
Pfeffer-/Salzmühle  
Moulin à poivre/sel  
Molinillo pimienta/sal

art.-P art.-S h. cm.  
42714P10 42714S10 10

**Olive wood.** – Ulivo.



W

**CHÂTEL Pepper/salt mill**

Macina pepe/sale  
Pfeffer-/Salzmühle  
Moulin à poivre/sel  
Molinillo pimienta/sal

art.-P art.-S h. cm.  
42707P21 42707S21 21

**Walnut.** – Noce.



W

**HOSTELLERIE Pepper mill**

Macina pepe  
Pfeffermühle  
Moulin à poivre  
Molinillo pimienta

art. h. cm. col.  
42741-22 22 ●  
42742-22 22 ●

**Natural & chocolate.** – Naturale & cioccolato.



W

SS

**ISEN Pepper mill/salt mill**

Macina pepe/sale  
Pfeffer-/Salzmühle  
Moulin à poivre/sel  
Molinillo pimienta/sal

art.-P art.-S h. cm.  
42682P18 42682S18 18

**Beech wood, black matt.** – Faggio nero opaco.



W  
SS

**ISEN Pepper mill/salt mill**

Macina pepe/sale  
Pfeffer-/Salzmühle  
Moulin à poivre/sel  
Molinillo pimienta/sal

art.-P art.-S h. cm.  
42683P18 42683S18 18

**Beech wood, natural.** – Faggio naturale.



W  
SS

**ROYAN Pepper/salt mill**

Macina pepe/sale  
Pfeffer-/Salzmühle  
Moulin à poivre/sel  
Molinillo pimienta/sal

art.-P art.-S h. cm.  
42677P14 42677S14 14

**Beech wood. Metallic finish that reveals the wood's grains.** – Faggio. Finitura metallica che rivela le venature del legno.



W

**MERIBEL Pepper mill**

Macina pepe  
Pfeffermühle  
Moulin à poivre  
Molinillo pimienta

art.-P art.-S h. cm.  
42685P14 42685S14 14

**Walnut. Cap highly matt finish, body brilliant finish in an acrylic envelope protecting the wood against humidity.** – Noce. Testa finitura opaca, corpo finitura brillante racchiuso in acrilico che protegge il legno dall'umidità.



NEW  
W  
SS

**FIDJI GRAPHITE Pepper/salt mill**

Macina pepe/sale  
Pfeffer-/Salzmühle  
Moulin à poivre/sel  
Molinillo pimienta/sal

art.-P art.-S h. cm.  
42655P15 42655S15 15

**Beech wood graphite.** – Faggio grafite.



W  
SS

**FIDJI OLIVE Pepper/salt mill**

Macina pepe/sale  
Pfeffer-/Salzmühle  
Moulin à poivre/sel  
Molinillo pimienta/sal

art.-P art.-S h. cm.  
42676P15 42676S15 15  
42676P20 42676S20 20

**Olive wood.** – Ulivo.



W  
SS

**FIDJI Pepper/salt mill**

Macina pepe/sale  
Pfeffer-/Salzmühle  
Moulin à poivre/sel  
Molinillo pimienta/sal

art.-P art.-S h. cm.  
42676P12 42676S12 12  
42676P15 42676S15 15  
42676P20 42676S20 20

**Beech wood, black matt.** – Faggio nero opaco.







**BALI FONTE Pepper mill**

Macina pepe  
Pfeffermühle  
Moulin à poivre  
Molinillo pimienta

art.	h. cm.	col.
42620P03	8	●
42620P01	8	●
42620P02	8	●

Cast iron. – Ghisa.



W

**BAYA Pepper/salt mill**

Macina pepe/sale  
Pfeffer-/Salzmühle  
Moulin à poivre/sel  
Molinillo pimienta/sal

art.-P	art.-S	h. cm.
42684P08	42684S08	8

Chocolate & natural. – Cioccolato & naturale.



ABS  
AY

**BALI Pepper mill**

Macina pepe  
Pfeffermühle  
Moulin à poivre  
Molinillo pimienta

art.	h. cm.	col.
42661-02	8	●
42661-03	8	●



ABS  
AY

**BALI Salt mill**

Macina sale  
Salzmühle  
Moulin à sel  
Molinillo sal

art.	h. cm.	col.
42661-06	8	○



ABS  
AY

**BRASSERIE Duo, pepper/salt mill**

Duo, macinapepe/sale  
Duo, Pfeffer-/Salzmühle  
Duo, moulin à poivre/sel  
Duo, molinillo pimienta/sal

art.	h. cm.
42710-11	11

Chromed. – Cromato.



AY  
SS

**DAMANI Pepper/salt mill**

Macina pepe/sale  
Pfeffer-/Salzmühle  
Moulin à poivre/sel  
Molinillo pimienta/sal

art.-P	art.-S	h. cm.
42764P16	42764S16	16
42764P21	42764S21	21

SELECT  
MOUTURE SUR MESURE





**MADRAS Pepper/salt mill**

Macina pepe/sale  
Pfeffer-/Salzmühle  
Moulin à poivre/sel  
Molinillo pimienta/sal

art.-P art.-S h. cm.  
42705P16 42705S16 16  
42705P21 42705S21 21

**Beech wood chocolate.** – Faggio cioccolato.



**MADRAS GRAPHITE Pepper/salt mill**

Macina pepe/sale  
Pfeffer-/Salzmühle  
Moulin à poivre/sel  
Molinillo pimienta/sal

art.-P art.-S h. cm.  
42717P16 42717S16 16

**Beech wood graphite.** – Faggio grafite.



**CHAUMONT Pepper/salt mill**

Macina pepe/sale  
Pfeffer-/Salzmühle  
Moulin à poivre/sel  
Molinillo pimienta/sal

art.-P art.-S h. cm.  
42798P11 42798S11 11



**VITTEL Pepper/salt mill**

Macina pepe/sale  
Pfeffer-/Salzmühle  
Moulin à poivre/sel  
Molinillo pimienta/sal

art.-P art.-S h. cm.  
42796P16 42796S16 16  
42796P23 42796S23 23



**NANCY Wet sea salt mill**

Macina per sale umido  
Mühle für Feuchtes Meersalz  
Moulin à sel humide  
Molinillo sal húmeda

art. h. cm.  
42728S18 18



**NANCY Pepper/salt mill**

Macina pepe/sale  
Pfeffer-/Salzmühle  
Moulin à poivre/sel  
Molinillo pimienta/sal

art.-P art.-S h. cm.  
42727-09 42728-09 9  
42727-12 42728-12 12  
42727-18 42728-18 18



**NANCY Pepper/salt mill**

Macina pepe/sale  
Pfeffer-/Salzmühle  
Moulin à poivre/sel  
Molinillo pimienta/sal

art.-P art.-S h. cm.  
42727-22 42728-22 22  
42727-30 42728-30 30  
42727-38 42728-38 38





AY  
W

**OLERON Wet sea salt mill**  
Macina per sale umido  
Mühle für Feuchtes Meersalz  
Moulin à sel humide  
Molinillo sal húmeda

art. h. cm.  
42670N14 14

**Beech wood.** – Faggio.



AY  
W

**OLERON Wet sea salt mill**  
Macina per sale umido  
Mühle für Feuchtes Meersalz  
Moulin à sel humide  
Molinillo sal húmeda

art. h. cm.  
42670B14 14

**Beech wood.** – Faggio.



AY

**MOLENE Wet sea salt mill**  
Macina per sale umido  
Mühle für Feuchtes Meersalz  
Moulin à sel humide  
Molinillo sal húmeda

art. h. cm.  
42670W14 14

**White.** – Bianco.



AY  
SS

**OSLO Wet sea salt mill**  
Macina per sale umido  
Mühle für Feuchtes Meersalz  
Moulin à sel humide  
Molinillo sal húmeda

art. h. cm.  
42678W14 14



AY  
SS

**OSLO Pepper/salt mill**  
Macina pepe/sale  
Pfeffer-/Salzmühle  
Moulin à poivre/sel  
Molinillo pimienta/sal

art.-P art.-S h. cm.  
42678P14 42678S14 14



NEW

AY  
W

**OSLO GRAPHITE Pepper/salt mill**  
Macina pepe/sale  
Pfeffer-/Salzmühle  
Moulin à poivre/sel  
Molinillo pimienta/sal

art.-P art.-S h. cm.  
42679P12 42679S12 12

**Beech wood graphite.** – Faggio grafite.





AY  
W

**OLERON Pepper/salt mill**

Macina pepe/sale  
Pfeffer-/Salzmühle  
Moulin à poivre/sel  
Molinillo pimienta/sal

art.-P art.-S h. cm.  
42662P14 42662S14 14

**Beech wood.** – Faggio.



AY  
W

**OLERON Herbs/chili mill**

Macina erbe/peperoncino  
Kräuter-/Paprikamühle  
Moulin à herbes/piment  
Molinillo hierbas/chile

art. h. cm.  
42662C14 14

**Beech wood.** – Faggio.



AY  
SS

**OUESSANT Pepper/salt mill**

Macina pepe/sale  
Pfeffer-/Salzmühle  
Moulin à poivre/sel  
Molinillo pimienta/sal

art.-P art.-S h. cm.  
42669P14 42669S14 14



AY  
SS

**OUESSANT Herbs/chili mill**

Macina erbe/peperoncino  
Kräuter-/Paprikamühle  
Moulin à herbes/piment  
Molinillo hierbas/chile

art. h. cm.  
42669C14 14



AY  
W

**OLERON Pepper/salt mill**

Macina pepe/sale  
Pfeffer-/Salzmühle  
Moulin à poivre/sel  
Molinillo pimienta/sal

art.-P art.-S h. cm.  
42663P14 42663S14 14

**Beech wood.** – Faggio.



AY  
W

**OLERON Herbs/chili mill**

Macina erbe/peperoncino  
Kräuter-/Paprikamühle  
Moulin à herbes/piment  
Molinillo hierbas/chile

art. h. cm.  
42663C14 14

**Beech wood.** – Faggio.



NEW  
W

**ISEN Nutmeg mill**

Macina noce moscata  
Muskatmühle  
Moulin à mouscade  
Molinillo nuez moscada

art. h. cm. col.  
42689-15 15 ●  
42690-15 15 ●

**Natural & black matt.** – Naturale & nero opaco.





SS  
AY

**DAMAN Nutmeg mill**  
Macina noce moscata  
Muskatmühle  
Moulin à mouscade  
Molinillo nuez moscada

art. h. cm.  
42764M15 15

**Magnetic stopper. Compartment for 3 nutmegs.**  
Tappo magnetico. Scompartimento per 3 noci.



W  
AY

**MADRAS Nutmeg mill**  
Macina noce moscata  
Muskatmühle  
Moulin à mouscade  
Molinillo nuez moscada

art. h. cm.  
42705M15 15

**Beech wood chocolate. Magnetic stopper. Compartment for 3 nutmegs.** – Faggio cioccolato. Tappo magnetico. Scompartimento per 3 noci.



AY  
ABS

**TERNATE Nutmeg mill**  
Macina noce moscata  
Muskatmühle  
Moulin à mouscade  
Molinillo nuez moscada

art. h. cm.  
42720-01 11

**Chromed. Compartment for 7/8 nutmegs.**  
Cromata. Serbatoio per 7/8 noci.



AG  
W

**PALACE Pepper/salt mill**  
Macina pepe/sale  
Pfeffer-/Salzmühle  
Moulin à poivre/sel  
Molinillo pimienta/sal

art.-P art.-S h. cm.  
42725P10 42725S10 10



AG

**MIGNONNETTE Pepper/salt mill**  
Macina pepe/sale  
Pfeffer-/Salzmühle  
Moulin à poivre/sel  
Molinillo pimienta/sal

art.-P art.-S h. cm.  
42723P10 42723S10 10



AY  
PC  
  

**ALASKA Duo, electric pepper/salt mill**  
Duo, macina pepe/sale, elettrici  
Duo, Pfeffer-/Salzmühle  
Duo, moulin à poivre/sel  
Duo, molinillo pimienta/sal

art. h. cm.  
42660-02 17



ABS  
  

**ZELI Pepper/salt mill**  
Macina pepe/sale  
Pfeffer-/Salzmühle  
Moulin à poivre/sel  
Molinillo pimienta/sal

art.-P art.-S h. cm.  
42801P14 42801S14 14

**Stainless steel look.** – Imitazione inox.



SS  
  
  

**ELIS SENSE Pepper/salt mill**  
Macina pepe/sale  
Pfeffer-/Salzmühle  
Moulin à poivre/sel  
Molinillo pimienta/sal

art.-P art.-S h. cm.  
42785S20 42786S20 20

**With small dish and spice vial with funnel.**  
Con vassoietto e fiala dosatrice con imbuto.





SS

**LANKA Cinnamon shaker/mill**

Macina & spargi cannella  
Zimt Shaker-/Mühle  
Shaker et moulin à cannelle  
Especiero y molinillo de canela

art. h. cm.

42685-22 22-7

**To grind cinnamon sticks (6 cm max). Shaker and mill function.** – Per macinare bastoncini di cannella (max 6 cm). Funzione shaker e macina.



W  
SS

**ISEN Flax seeds mill**

Macina semi lino/sesamo  
Leinsamen-Mühle  
Moulin à graines de lin  
Molino de semillas de lino

art. h. cm.

42680-13 13

**Supplied with spoon of 5 g. and brush.**  
Fornito con un cucchiaino da 5 g. e scovolino.



W  
SS

**ISEN Long pepper mill**

Macina pepe lungo  
Langer Pfeffermühle  
Moulin à poivres longs  
Molinillo de pimienta larga

art. h. cm.

42681-16 16

**To grind long pepper and very large peppercorns. Adjustable grinding. Comes with cleaning brush. Also works for cardamom, star anise, tonka beans, cloves, coriander.** – Per macinare pepe lungo e grani di pepe molto grandi. Regolabile. Fornito con scovolino. Funziona anche con cardamomo, anice stellato, fave tonka, chiodi di garofano, coriandolo.



# PEUGEOT APPOLIA



TABLE TOP  
TAVOLA

NEW





## ENAMELLED STONEWARE GRES SMALTATO



FACILE DA PULIRE

With the range of Appolia vitrified enamel ceramics, Peugeot demonstrates its know-how and expertise in the field of oven dishes.



COLORE E BRILLANTEZZA  
DI LUNGA DURATA

It is in France, in the heart of Brittany, in its ceramic factory founded more than 80 years ago, that Peugeot produces Appolia products. The workshop has awarded the EPV label "Entreprise du Patrimoine Vivant" - a sign of recognition by the State that distinguishes French companies with excellent craftsmanship and industrial know-how.



SUPERFICIE ULTRA  
LISCIA ANTIABRASIONE

A noble material, Peugeot ceramic guarantees regular and homogeneous cooking for a healthy and tasty cuisine. A well-kept secret, the recipe for ceramic paste, a mix of clay, kaolin and feldspar, gives the product a remarkable resistance to mechanical shocks.

Simple and contemporary lines, Appolia has been designed to offer practicality and express flavors.

Con la gamma di ceramiche smaltate Appolia, Peugeot dimostra il suo know-how e la sua competenza nel campo delle pirofile da forno.

È in Francia, nel cuore della Bretagna, nella sua manifattura di ceramica fondata da più di 80 anni, che Peugeot produce i prodotti Appolia. L'officina è stata premiata con l'etichetta EPV "Entreprise du Patrimoine Vivant" - un segno di riconoscimento da parte dello Stato che distingue le aziende francesi con un'eccellente know-how artigianale e industriale.

Un materiale nobile, la ceramica Peugeot garantisce una cottura regolare e omogenea per una cucina sana e gustosa. Un segreto ben custodito, la ricetta della pasta ceramica, un mix di argilla, caolino e feldspato, conferisce al prodotto una notevole resistenza agli urti meccanici.

Linee pulite e contemporanee, Appolia è stata progettata per offrire praticità ed esprimere i sapori.



Appolia dishes are suitable for use in the oven (250°C), microwave, freezer (-20°C). Dishwasher safe. Produced with 100% natural ingredients (mixture of clays, kaolin, silica, feldspar), 100% recyclable. They guarantee a delicate and tasty, healthy and homogeneous cooking. They have exceptional thermal inertia: they retain heat for up to 30 minutes - they help keep food hot or cold. The material is not porous, does not absorb odors, greases or liquids. The hardness of the final product gives the oven dishes a high mechanical resistance to shocks, scratches and acids. The resistance of Peugeot vitrified enamel has been tested by an independent laboratory. Easy to clean with a simple sponge. Long-lasting color and shine. Comfortable and easy to use, wide and striped handles for a secure grip; rounded corners, facilitate service and cleaning; deep, they offer more volume; allow the retention of cooking juices in order to preserve all the flavors, they are stackable one inside the other to save space. A collection for every day, beautiful, durable and versatile for the table. Available in 6 colors: red, ecru, blue - timeless and essential shades; slate, eggplant, terracotta - contemporary and chic shades

Le pirofile Appolia sono idonee all'uso in forno (250°C), microonde, congelatore (-20°C). Lavabili in lavastoviglie. Prodotte con ingredienti naturali al 100% (miscela di argille, caolino, silice, feldspato), 100% riciclabili. Garantiscono una cottura delicata e gustosa, sana e omogenea. Hanno eccezionale inerzia termica: trattengono il calore fino a 30 minuti - aiutano a mantenere il cibo caldo o freddo. Il materiale non è poroso, non assorbe odori, grassi o liquidi. La durezza del prodotto finale conferisce alle pirofile un'elevata resistenza meccanica agli urti, graffi e acidi. La resistenza dello smalto vetrificato di Peugeot è stata testata da un laboratorio indipendente. Facile da pulire con una semplice spugna. Colore e brillantezza di lunga durata. Comode e facili da usare, maniglie larghe e striate per una presa sicura; angoli arrotondati, facilitano il servizio e la pulizia; profonde, offrono più volume; consentono la ritenzione dei succhi di cottura in modo da preservare tutti i sapori, sono impilabili l'una nell'altra per un risparmio di spazio. Una collezione per tutti i giorni, bella, durevole e versatile dalla cucina alla tavola. Disponibile in 6 colori: rosso, ecru, blu - tonalità senza tempo ed essenziali; ardesia, melanzana, terracotta - tonalità contemporanee e chic.



**Rectangular baker**

Pirofila Rettangolare  
Rechteckige Ofenschale  
Plat four rectangulaire  
Plato horno rectangular

art.	cm. int.	cm. est.	lt.	Kg.
44701B25	20x15,5x5,5	25x16,8x6,2	1,4	0,9
44701B32	26x20x6,5	32x21,7x7,2	2,7	1,7
44701B40	33x25,7x7,5	40x27,2x8,3	5,2	2,8



**Rectangular baker**

Pirofila Rettangolare  
Rechteckige Ofenschale  
Plat four rectangulaire  
Plato horno rectangular

art.	cm. int.	cm. est.	lt.	Kg.
44701C25	20x15,5x5,5	25x16,8x6,2	1,4	0,9
44701C32	26x20x6,5	32x21,7x7,2	2,7	1,7
44701C40	33x25,7x7,5	40x27,2x8,3	5,2	2,8



**Rectangular baker**

Pirofila Rettangolare  
Rechteckige Ofenschale  
Plat four rectangulaire  
Plato horno rectangular

art.	cm. int.	cm. est.	lt.	Kg.
44701M25	20x15,5x5,5	25x16,8x6,2	1,4	0,9
44701M32	26x20x6,5	32x21,7x7,2	2,7	1,7
44701M40	33x25,7x7,5	40x27,2x8,3	5,2	2,8



**Rectangular baker**

Pirofila Rettangolare  
Rechteckige Ofenschale  
Plat four rectangulaire  
Plato horno rectangular

art.	cm. int.	cm. est.	lt.	Kg.
44701R25	20x15,5x5,5	25x16,8x6,2	1,4	0,9
44701R32	26x20x6,5	32x21,7x7,2	2,7	1,7
44701R40	33x25,7x7,5	40x27,2x8,3	5,2	2,8







**Rectangular baker**

Pirofila Rettangolare  
Rechteckige Ofenschale  
Plat four rectangulaire  
Plato horno rectangular

art.	cm. int.	cm. est.	lt.	Kg.
44701S25	20x15,5x5,5	25x16,8x6,2	1,4	0,9
44701S32	26x20x6,5	32x21,7x7,2	2,7	1,7
44701S40	33x25,7x7,5	40x27,2x8,3	5,2	2,8

**Rectangular baker**

Pirofila Rettangolare  
Rechteckige Ofenschale  
Plat four rectangulaire  
Plato horno rectangular

art.	cm. int.	cm. est.	lt.	Kg.
44701T25	20x15,5x5,5	25x16,8x6,2	1,4	0,9
44701T32	26x20x6,5	32x21,7x7,2	2,7	1,7
44701T40	33x25,7x7,5	40x27,2x8,3	5,2	2,8



**Square baker**

Pirofila Quadra  
Quadratische Ofenschale  
Plat four carré  
Plato horno cuadrado

art.	cm. int.	cm. est.	lt.	Kg.
44702B21	16,3x16,3x5,4	21x17,5x6	1,1	0,8
44702B28	22,5x22,5x6,5	28x23,7x7,2	2,7	1,6
44702B36	29,5x29,5x7,5	36x31x8,2	5,4	2,8

**Square baker**

Pirofila Quadra  
Quadratische Ofenschale  
Plat four carré  
Plato horno cuadrado

art.	cm. int.	cm. est.	lt.	Kg.
44702C21	16,3x16,3x5,4	21x17,5x6	1,1	0,8
44702C28	22,5x22,5x6,5	28x23,7x7,2	2,7	1,6
44702C36	29,5x29,5x7,5	36x31x8,2	5,4	2,8



**Square baker**  
Pirofila Quadra  
Quadratische Ofenschale  
Plat four carré  
Plato horno cuadrado

art.	cm. int.	cm. est.	lt.	Kg.
44702M21	16,3x16,3x5,4	21x17,5x6	1,1	0,8
44702M28	22,5x22,5x6,5	28x23,7x7,2	2,7	1,6
44702M36	29,5x29,5x7,5	36x31x8,2	5,4	2,8

**Square baker**  
Pirofila Quadra  
Quadratische Ofenschale  
Plat four carré  
Plato horno cuadrado

art.	cm. int.	cm. est.	lt.	Kg.
44702R21	16,3x16,3x5,4	21x17,5x6	1,1	0,8
44702R28	22,5x22,5x6,5	28x23,7x7,2	2,7	1,6
44702R36	29,5x29,5x7,5	36x31x8,2	5,4	2,8



**Square baker**  
Pirofila Quadra  
Quadratische Ofenschale  
Plat four carré  
Plato horno cuadrado

art.	cm. int.	cm. est.	lt.	Kg.
44702S21	16,3x16,3x5,4	21x17,5x6	1,1	0,8
44702S28	22,5x22,5x6,5	28x23,7x7,2	2,7	1,6
44702S36	29,5x29,5x7,5	36x31x8,2	5,4	2,8

**Square baker**  
Pirofila Quadra  
Quadratische Ofenschale  
Plat four carré  
Plato horno cuadrado

art.	cm. int.	cm. est.	lt.	Kg.
44702T21	16,3x16,3x5,4	21x17,5x6	1,1	0,8
44702T28	22,5x22,5x6,5	28x23,7x7,2	2,7	1,6
44702T36	29,5x29,5x7,5	36x31x8,2	5,4	2,8





**Round baker**  
Pirofila Tonda  
Runde Ofenschale  
Plat four rond  
Plato horno redondo

art.	Ø cm.	h. cm.	cm. est.	lt.	Kg.
44703B27	23	6	27x23,4x6,7	2,1	1,15
44703B34	30	7	34x29,5x7,7	3,8	2,1

**Round baker**  
Pirofila Tonda  
Runde Ofenschale  
Plat four rond  
Plato horno redondo

art.	Ø cm.	h. cm.	cm. est.	lt.	Kg.
44703C27	23	6	27x23,4x6,7	2,1	1,15
44703C34	30	7	34x29,5x7,7	3,8	2,1





**Round baker**

Pirofila Tonda  
Runde Ofenschale  
Plat four rond  
Plato horno redondo

art.	Ø cm.	h. cm.	cm. est.	lt.	Kg.
44703R27	23	6	27x23,4x6,7	2,1	1,15
44703R34	30	7	34x29,5x7,7	3,8	2,1



**Round baker**

Pirofila Tonda  
Runde Ofenschale  
Plat four rond  
Plato horno redondo

art.	Ø cm.	h. cm.	cm. est.	lt.	Kg.
44703S27	23	6	27x23,4x6,7	2,1	1,15
44703S34	30	7	34x29,5x7,7	3,8	2,1



**Bread pan with lid**

Stampo Pane Con Coperchio  
Brotform Mit Deckel  
Plaque multipains avec couvercle  
Plato panadero con tapa

art.	cm. int.	cm. est.	Kg.
44705C37	31,5x21	37,5x22,7x7,5	3



**Oval baker**

Pirofila Ovale  
Ovale Ofenschale  
Plat four ovale  
Plato horno ovalado

art.	cm. int.	cm. est.	lt.	Kg.
44706B31	27x20x6	31x21,5x7	2,2	1,4
44706B40	34,5x25,5x7,5	40x27,2x8,2	4,5	2,4



**Oval baker**

Pirofila Ovale  
Ovale Ofenschale  
Plat four ovale  
Plato horno ovalado

art.	cm. int.	cm. est.	lt.	Kg.
44706C31	27x20x6	31x21,5x7	2,2	1,4
44706C40	34,5x25,5x7,5	40x27,2x8,2	4,5	2,4







**Oval baker**

Pirofila Ovale  
Ovale Ofenschale  
Plat four ovale  
Plato horno ovalado

art.	cm. int.	cm. est.	lt.	Kg.
44706R31	27x20x6	31x21,5x7	2,2	1,4
44706R40	34,5x25,5x7,5	40x27,2x8,2	4,5	2,4



**Oval baker**

Pirofila Ovale  
Ovale Ofenschale  
Plat four ovale  
Plato horno ovalado

art.	cm. int.	cm. est.	lt.	Kg.
44706S31	27x20x6	31x21,5x7	2,2	1,4
44706S40	34,5x25,5x7,5	40x27,2x8,2	4,5	2,4



**Meat pie dish**

Pirofila Tonda  
Fleischpastete Ofenschale  
Plat four rond  
Plato horno redondo

art.	Ø cm.	h. cm.	cm. est.	lt.	Kg.
44708B28	28	4,5	33x28,3x5,4	2,2	1,5



**Meat pie dish**

Pirofila Tonda  
Fleischpastete Ofenschale  
Plat four rond  
Plato horno redondo

art.	Ø cm.	h. cm.	cm. est.	lt.	Kg.
44708C28	28	4,5	33x28,3x5,4	2,2	1,5



**Meat pie dish**

Pirofila Tonda  
Fleischpastete Ofenschale  
Plat four rond  
Plato horno redondo

art.	Ø cm.	h. cm.	cm. est.	lt.	Kg.
44708R28	28	4,5	33x28,3x5,4	2,2	1,5

**Meat pie dish**

Pirofila Tonda  
Fleischpastete Ofenschale  
Plat four rond  
Plato horno redondo

art.	Ø cm.	h. cm.	cm. est.	lt.	Kg.
44708S28	28	4,5	33x28,3x5,4	2,2	1,5

## PACKAGING IMBALLO



All dishes are packed with a cardboard tie that highlights the design, color and shine of the product. Protects when nested and allows for creative in-store merchandising. A tasty mood picture to inspire the final customer and a precise diagram of inner and outer dimensions, icons of use and safety and a reminder of the entire Appolia range.

Tutte le pirofile sono confezionate con una cravatta di cartone che lascia in evidenza il design, il colore e la lucentezza del prodotto. Proteggere quando impilate e consente un merchandising creativo in negozio. Riporta un'immagine ambientata per ispirare il cliente finale, un diagramma preciso delle dimensioni interne ed esterne per assistere il cliente nella scelta, icone di utilizzo e sicurezza e un promemoria dell'intera gamma Appolia.



# SERIES LIVING

TABLE TOP  
TAVOLA



A complete stainless steel line, that is able to join assortment, beauty, strenght and functionality. Quality items that can be used in order to set the most charming tables and buffets, but also in order to have a well-equipped kitchen. The easiest way to serve with charm any kind of dishes: from spaghetti to meat, fish, bread, vegetables, cheese and fruit. It is also indicated for tiny preparations such as sweets, olives and pickles. Nothing will unintentionally escape!

Una linea completa capace di coniugare assortimento, bellezza, robustezza e funzionalità, realizzata in acciaio inox. Oggetti di qualità per apparecchiare le tavole ed i buffet più raffinati, ma anche per disporre quotidianamente di una cucina super-attrezzata. Il modo più pratico per servire con eleganza e facilità ogni tipo di pietanza dagli spaghetti alla carne, pesce, pane, verdure, formaggi e frutta ma anche piccoli alimenti come dolci, olive e sottaceti. Niente potrà sfuggire inavvertitamente!





**Vegetables serving plier**

Forbice per verdure  
Salad-/Gemüsezange  
Pince à légumes  
Pinza verduras

art.	dim. cm.
12550-81	24



**Serving plier**

Forbice tutto servire  
Servierzange  
Pince à servir  
Pinza servir

art.	dim. cm.
12550-83	21,0
12550-84	26,5
12550-85	24,0



**Pie plier**

Forbice per torta  
Kuchenzange  
Pince à tarte  
Pinza pasteles

art.	dim. cm.
12550-80	28



**Hors-d'oeuvres and pastry plier**

Forbice per antipasti e dolci  
Vorspeisen-/Pâtisseriezange  
Pince à hors-d'oeuvres et pâtisserie  
Pinza entremeses y pasteles

art.	dim. cm.
12550-87	15
12550-89	20



**Pastry plier**

Forbice per dolci  
Gebäckzange  
Pince à pâtisserie  
Pinza pasteles

art.	dim. cm.
12550-88	18



**Fruit tongs**

Molla per frutta  
Fruchtzange  
Pince à fruits  
Pinza frutas

art.	dim. cm.
12550-50	23,5



**Spaghetti tongs**

Molla per spaghetti  
Spaghettizange  
Pince à spaghetti  
Pinza espagueti

art.	dim. cm.
12550-73	21
12550-74	30



**Toast and pastry tongs**

Molla per toast e dolci  
Toast-/Gebäckzange  
Pince à toast et tarte  
Pinza pasteles y tostadas

art.	dim. cm.
12550-77	21
12550-78	24



**Multipurpose tongs**

Molla universale  
Universalzange  
Pince universelle  
Pinza universal

art.	dim. cm.
12550-58	30



**Serving tongs**

Molla tutto servire  
Servierzange  
Pince à servir  
Pinza asados y verduras

art.	dim. cm.
12550-68	21
12550-69	26
12550-70	30



**Bread and pastry tongs**

Molla per pane e pasticceria  
Brot-/Gebäckzange  
Pince à pain et pâtisserie  
Pinza pan y pasteles

art.	dim. cm.
12550-62	18
12550-63	23
12550-64	26





**Snail tongs**

Molla per lumache  
Schneckenzange  
Pince à escargots  
Pinza caracoles

art. dim. cm.  
12550-60 17



**Asparagus tongs**

Molla per asparagi  
Spargelzange  
Pince à asperges  
Pinza espárragos

art. dim. cm.  
12550-66 23



**Ice tongs**

Molla per ghiaccio  
Eiszange  
Pince à glace  
Pinza hielo

art. dim. cm.  
12550-56 17,5



**Sugar tongs**

Molla per zucchero  
Zuckerzange  
Pince à sucre  
Pinza azúcar

art. dim. cm.  
12550-53 12



**Sugar tongs**

Molla per zucchero  
Zuckerzange  
Pince à sucre  
Pinza azúcar

art. dim. cm.  
12550-54 12,5



**Ice tongs**

Molla per ghiaccio  
Eiszange  
Pince à glace  
Pinza hielo

art. dim. cm.  
12550-55 18,5



**Panettone knife**

Coltello panettone  
Tortenmesser  
Couteau à gâteau  
Cuchillo tarta

art. dim. cm.  
12550-34 32



**Cake server**

Pala torta  
Tortenheber  
Pelle à gâteau  
Pala tarta

art. dim. cm.  
12550-02 30



**Serving fork**

Forchetta a servire  
Serviergabel  
Fourchette à servir  
Tenedor servir

art. dim. cm.  
12550-11 29,5  
12550-12 26,0



**Serving spoon**

Cucchiaio a servire  
Servierlöffel  
Cuiller à servir  
Cuchara servir

art. dim. cm.  
12550-13 30,0  
12550-14 25,5  
12550-22 39,0





**Serving spoon perforated**

Cucchiaio a servire forato  
Servierlöffel, perforiert  
Cuiller à servir perforée  
Cuchara servir, perforada

art.	dim. cm.
12550-25	25,5
12550-26	30,0



**Ladle**

Mestolo  
Schöpfer  
Louche  
Cazo

art.	dim. cm.
12550-01	25,5



**Sauce ladle**

Coppino salsa  
Dressingschöpfer  
Louche à sauce  
Cazillo salsas

art.	dim. cm.
12550-20	16



**Perforated sauce ladle**

Coppino forato  
Dressingschöpfer, gelocht  
Louche à sauce percée  
Cazillo, perforado

art.	dim. cm.
12550-21	16,5



**Spaghetti serving fork**

Forchettone spaghetti  
Spaghettivorlegegabel  
Fourchette à servir spaghetti  
Tenedor servir espagueti

art.	dim. cm.
12550-15	28,5



**Rice ladle**

Cucchiaio risotto  
Reislöffel  
Cuiller à risotto  
Cuchara arroz

art.	dim. cm.
12550-16	28



**Meat fork**

Forchettone  
Tranchiergabel  
Fourchette  
Tenedor

art.	dim. cm.
12550-30	32



**Roast beef knife**

Coltello arrosto  
Tranchiermesser  
Couteau à rôtis  
Cuchillo roastbeef

art.	dim. cm.
12550-33	32



**Salt spoon**

Cucchiaino sale  
Salzlöffel  
Cuiller à sel  
Cucharita para sal

art.	dim. cm.	U. Pack
12550-17	6,5	6



**Ice tea spoon**

Cucchiaio bibita  
Limonadenlöffel  
Cuillère à soda  
Cuchara refresco

art.	dim. cm.	U. Pack
12550-36	19,5	6



**Oyster fork**

Forchettina ostriche  
Austerngabel  
Fourchette à huîtres  
Tenedor ostras

art.	dim. cm.	U. Pack
12550-43	14	6





**Escargot fork**

Forchetta per lumache  
Schneckengabel  
Fourchette à escargots  
Tenedor caracoles

art.	dim. cm.	U. Pack
12550-19	14	6



**Ice spoon**

Cucchiaio ghiaccio  
Eislöffel  
Cuillère à glace  
Cuchara hielo

art.	dim. cm.
12550-04	22



**Dressing spoon**

Cucchiaio salsa  
Saucenlöffel  
Cuillère à sauce  
Cuchara salsa

art.	dim. cm.
12550-06	22



**Monoportion spoon**

Cucchiaio monoporzione  
Monoporzion-Löffel  
Cuillère monoportion  
Cuchara monoporción

art.	dim. cm.	U. Pack
12550-03	9,5	6
12550-07	12,0	6



**Monoportion fork**

Forchetta monoporzione  
Monoporzion-Gabel  
Fourchette monoportion  
Tenedor monoporción

art.	dim. cm.	U. Pack
12550-05	9,5	6



**Monoportion fork**

Forchetta monoporzione  
Monoporzion-Gabel  
Fourchette monoportion  
Tenedor monoporción

art.	dim. cm.	U. Pack
12550-09	12	6





# DISPLAY & PRESENTATION

BUFFET





**Serving stand, chrome plated**  
Supporto cromato  
Serviergestell, hartverchromt  
Présentoir, acier chromé  
Soporte platos pastre, acero cromado  
art. dim. cm.  
44840-01 29x17x41

**For 3 plates cm. 18x18 or 21x21.**  
Per 3 piatti cm. 18x18 oppure 21x21.



**Serving stand, chrome plated**  
Supporto cromato  
Serviergestell, hartverchromt  
Présentoir, acier chromé  
Soporte platos pastre, acero cromado  
art. dim. cm.  
44840-02 33x21x44

**For 3 plates cm. 21x21 or 26,5x26,5.**  
Per 3 piatti cm. 21x21 oppure 26,5x26,5.



**Serving stand, chrome plated**  
Supporto cromato  
Serviergestell, hartverchromt  
Présentoir, acier chromé  
Soporte platos pastre, acero cromado  
art. dim. cm.  
44840-03 37x21x44

**For 3 plates cm. 30x21. – Per 3 piatti cm. 30x21.**



**Serving stand, chrome plated**  
Supporto cromato  
Serviergestell, hartverchromt  
Présentoir, acier chromé  
Soporte platos pastre, acero cromado  
art. dim. cm.  
44840-04 63x27x44,5

**For 2 plates cm. 53x32,5 or 4 plates cm. 53x16,2.**  
Per 2 piatti cm. 53x32,5 oppure 4 piatti cm. 53x16,2.



**Serving stand, chrome plated**  
Supporto cromato  
Serviergestell, hartverchromt  
Présentoir, acier chromé  
Soporte platos pastre, acero cromado  
art. dim. cm.  
44840-05 37,5x37,5x50

**For plates in 3 different sizes: cm. 21x21-26,5x26,5-37x37. – Per piatti di 3 diverse misure: cm. 21x21-26,5x26,5-37x37.**



**Serving stand, chrome plated**  
Supporto cromato  
Serviergestell, hartverchromt  
Présentoir, acier chromé  
Soporte, acero cromado  
art. Ø cm. h. cm.  
44840-27 22 59

**Suitable glasses/Vasetti idonei: 41589C08, 41589C16, 41589-08, 41589-14, 41589-16.**



**Serving stand, chrome plated**  
Supporto cromato  
Serviergestell, hartverchromt  
Présentoir, acier chromé  
Soporte, acero cromado  
art. Ø cm. h. cm.  
44840-28 22 33

**Suitable glasses/Vasetti idonei: 41589C08, 41589C16, 41589-08, 41589-14, 41589-16.**



**Square bowl**  
Ciotola quadra  
Schüssel, quadratisch  
Bol carré  
Bol cuadrado  
art. dim. cm.  
44847B09 9x9x4  
44847B13 12,5x12,5x6,5  
44847B20 19x19x9

**MF**



MF

**Square bowl**  
Ciotola quadra  
Schüssel, quadratisch  
Bol carré  
Bol cuadrado

art.	dim. cm.
44847-09	9x9x4
44847-13	12,5x12,5x6,5
44847-20	19x19x9



MF

**Round bowl**  
Ciotola tonda  
Schüssel, rund  
Bol ronde  
Bol redondo

art.	Ø cm.	h. cm.
44846B05	5,5	4,0
44846B09	9,0	4,5
44846B13	13,0	6,5
44846B15	15,0	7,5



MF

**Round bowl**  
Ciotola tonda  
Schüssel, rund  
Bol ronde  
Bol redondo

art.	Ø cm.	h. cm.
44846-05	5,5	4,0
44846-09	9,0	4,5
44846-13	13,0	6,5
44846-15	15,0	7,5



MF

**Party plate**  
Piattino fingerfood  
Fingerfood-Teller  
Petit assiette  
Platillo

art.	dim. cm.	col.
44844-01	9,5x9,5x1,5	○
44844B01	9,5x9,5x1,5	●



GN

MF

**Tray**  
Vassoio  
Tablett  
Plateau  
Bandeja

art.	dim. cm.	GN
44844-11	53x32,5x2,5	1/1



MF

**Tray, square**  
Vassoio quadro  
Tablett, quadratisch  
Plateau carré  
Bandeja, cuadrada

art.	dim. cm.
44841-18	18x18
44841-21	21x21
44841-26	26,5x26,5
44841-37	37x37
44841-51	51x51



MF

**Tray, square**  
Vassoio quadro  
Tablett, quadratisch  
Plateau carré  
Bandeja, cuadrada

art.	dim. cm.
44841B51	51x51







**MF**

**Sushi tray**

Vassoio sushi  
Sushiplatte  
Plateau sushi  
Bandeja sushi

art.	dim. cm.
44842B31	31x10,5
44842B53	53x18



**MF**

**Sushi tray**

Vassoio sushi  
Sushiplatte  
Plateau sushi  
Bandeja sushi

art.	dim. cm.
44842-31	31x10,5
44842-35	35,5x18
44842-30	30x21
44842-53	53x18



GN

**MF**

**Tray**

Vassoio  
Tablett  
Plateau  
Bandeja

art.	dim. cm.	GN
44843-11	53x32,5	1/1
44843-12	32,5x26,5	1/2
44843-24	53x16,2	2/4
44843-13	32,5x17,5	1/3
44843-14	26,5x16,2	1/4



GN

**MF**

**Tray**

Vassoio  
Tablett  
Plateau  
Bandeja

art.	dim. cm.	GN
44843B11	53x32,5	1/1
44843B12	32,5x26,5	1/2
44843B24	53x16,2	2/4
44843B13	32,5x17,5	1/3
44843B14	26,5x16,2	1/4



**MF**

**Round dish**

Piatto tondo  
Platte, rund  
Plat rond  
Bandeja redonda

art.	Ø cm.
44845-51	51
44845-30	30
44845-41	41



**MF**

**Bowl**

Ciotola  
Schale  
Bol  
Bol

art.	Ø cm.	h. cm.	ml.
44466-07	7	6	50



**MF**

**Bowl**

Ciotola  
Schale  
Bol  
Bol

art.	dim. cm.	lt.
44466-11	7,5x7x4,5	0,05



**MF**

**Bowl**

Ciotola  
Schale  
Bol  
Bol

art.	dim. cm.	lt.
44466-12	11,5x7,5x3	0,06



**MF**

**Bowl**

Ciotola  
Schale  
Bol  
Bol

art.	dim. cm.	lt.
44466-13	11,5x6x5,5	0,04



**MF**

**Bowl**

Ciotola  
Schale  
Bol  
Bol

art.	dim. cm.	lt.
44466-14	8,5x7x6	0,07



**MF**

**Bowl**

Ciotola  
Schale  
Bol  
Bol

art.	dim. cm.	lt.
44466-15	8x8x4	0,1



**MF**

**Bowl**

Ciotola  
Schale  
Bol  
Bol

art.	dim. cm.	lt.
44466-16	35x4,5x3	0,2





MF

**Party spoon**

Cucchiaio finger-food  
Finger-food-Löffel  
Cuiller  
Cucharita

art.	dim. cm.	col.
44850-11	11x4,3	○
44850B11	10x4,5	●



MF

**Party spoon**

Cucchiaio finger-food  
Finger-food-Löffel  
Cuiller  
Cucharita

art.	dim. cm.	col.
44850-13	13,5x4,5	○
44850B13	13,5x4,5	●



MF

**Party spoon**

Cucchiaio finger-food  
Finger-food-Löffel  
Cuiller  
Cucharita

art.	dim. cm.	col.
44850-12	10x4,5x1	○
44850B12	10x4,5x1	●
44850G12	10x4,5x1	●



MF

**Party spoon**

Cucchiaio finger-food  
Finger-food-Löffel  
Cuiller  
Cucharita

art.	dim. cm.
44851-01	14,5x4,5



MF

**Party spoon**

Cucchiaio finger-food  
Finger-food-Löffel  
Cuiller  
Cucharita

art.	dim. cm.	col.
44851-02	14,5x4,5	○
44851-03	14,5x4,5	●



MF

**Spoon, set 6 pcs**

Cucchiaio, set 6 pz  
Löffel, 6er Set  
Cuiller, set 6 pcs  
Cuchara, set 6 pz

art.	dim. cm.	col.
44850-00	6x23	○



PVD

SS

**Party spoon**

Cucchiaio gourmet  
Gourmet-Löffel  
Cuiller gourmet  
Cuchara gourmet

art.	l. cm.	col.
42988-99	13,5	●
42988C99	12,0	●
42988G99	12,0	●



MF

**Bowl oval**

Pirofila ovale  
Schale, oval  
Plat oval  
Fuente ovale

art.	dim. cm.	lt.
44849-27	27x17x4	0,8
44849-34	34x21x4,5	1,3
44849-47	47x29x5	3,2





MF

**Bowl**  
Insalatiera  
Schüssel  
Saladier  
Bol

art.	Ø cm.	h. cm.
44836-30	30	10



MF

**Bowl**  
Insalatiera  
Schüssel  
Saladier  
Bol

art.	dim. cm.
44834-03	40x18,5x10



MF

**Plate**  
Piatto  
Platte  
Plaque  
Plato

art.	dim. cm.
44835-36	36x16x3
44835-45	45x24x3
44835-53	53x29x3,5



MF

**Plate**  
Piatto  
Platte  
Plaque  
Plato

art.	dim. cm.
44834-00	34,5x8x2,5



MF

**Plate**  
Piatto  
Platte  
Plaque  
Plato

art.	dim. cm.
44834-01	40x18,5x3,5
44834-02	52x25x4



MF

**Bowl**  
Insalatiera  
Schüssel  
Saladier  
Bol

art.	dim. cm.
44834G03	40x18,5x10



MF

**Bowl**  
Insalatiera  
Schüssel  
Saladier  
Bol

art.	Ø cm.	h. cm.
44836G30	30	10



MF

**Plate**  
Piatto  
Platte  
Plaque  
Plato

art.	dim. cm.
44835G36	36x16x3
44835G45	45x24x3
44835G53	53x29x3,5



MF

**Plate**  
Piatto  
Platte  
Plaque  
Plato

art.	dim. cm.
44834G00	34,5x8x2,5



MF

**Plate**  
Piatto  
Platte  
Plaque  
Plato

art.	dim. cm.
44834G01	40x18,5x3,5
44834G02	52x25x4

TAO MELAMINE



Mirror shiny inside, outside matt.

Interno lucido, esterno satinato.



**Bowl**  
Ciotola  
Schale  
Bol  
Bol

art.	dim. cm.	lt.	col.
44449-32	32,5x17,5x10	1,8	○
44449B32	32,5x17,5x10	1,8	●



**Bowl**  
Ciotola  
Schale  
Bol  
Bol

art.	dim. cm.	lt.	col.
44449-30	30,5x30,5x10	3,3	○
44449B30	30,5x30,5x10	3,3	●



**Bowl**  
Ciotola  
Schale  
Bol  
Bol

art.	dim. cm.	col.
44446-10	10,5x10x6,5	○
44446-14	13,5x12,5x8,5	○
44446-18	17x16x10,5	○



**Bowl**  
Ciotola  
Schale  
Bol  
Bol

art.	dim. cm.	col.
44446B10	10,5x10x6,5	●
44446B14	13,5x12,5x8,5	●
44446B18	17x16x10,5	●



**Tray**  
Vassoio  
Tablett  
Plateau  
Bandeja

art.	dim. cm.	col.
44842-31	31x10,5x2	○
44842B31	31x10,5x2	●







Withstands temperatures from -20°C to +70°C.

Termoresistenti da -20°C a +70°C.



**Serving board**

Tagliere  
Servier-Brett  
Planche

**Tabla**

art.	Ø cm.	h. cm.
44470-30	30	1
44470-40	40	1



**Platter**

Plancia  
Tablett  
Plateau  
Bandeja

art.	dim. cm.	GN
44470-11	53,0x32,5x1	1/1
44470-24	53,0x16,2x1	2/4
44470-12	32,5x26,5x1	1/2
44470-13	32,5x17,5x1	1/3
44470-14	26,5x16,5x1	1/4



**Platter**

Plancia  
Tablett  
Plateau  
Bandeja

art.	dim. cm.
44470-73	20x10x2
44470-74	30x10x2
44470-75	30x15x2



**Bowl**

Ciotola  
Schüssel  
Bol  
Bol Ensalada

art.	dim. cm.	lt.
44470-03	19x19x9	1,5
44470-04	25x25x12	3,8





NEW

**Cake/cheese tray**  
Piatto torta/formaggi  
Kuchen/Käseplatte  
Plat gâteau/fromage  
Bandeja pasteles/queso

art.	Ø cm.	h. cm.
44470-22	21,5	2,5
44470-31	30,5	3,5
44470-38	37,5	4,0

**With non-slip feet. With carved edge fixing the cover.** – Con piedini antiscivolo. Con bordo fissa-coperchio.



NEW

PC

**Dome cover**  
Campana  
Haube  
Cloche  
Campana

art.	dim. cm.	fits/per
41414-21	21x17	44470-22
41414-31	30x22	44470-31
41414-36	36x27	44470-38

GLOBAL MELAMINE



**Bowl**  
Ciotola  
Schale  
Bol  
Bol

art.	dim. cm.
44889-32	32,5x32,5x12
44889-35	35x35x12,5
44889-40	40x40x14



**Bowl**  
Ciotola  
Schale  
Bol  
Bol

art.	Ø cm.	h. cm.
44888-32	32	16,5
44888-35	35	17,0
44888-40	40	17,5



**Bowl**  
Ciotola  
Schale  
Bol  
Bol

art.	dim. cm.	lt.
44882-35	35,5x31,5x14	2,5
44882-46	46x40x18,5	5,5



**BUFFET**



**Plate**  
Piatto  
Teller  
Assiette  
Plato

art.	Ø cm.	h. cm.
44477-24	11,0	2
44477-25	16,0	2
44477-26	19,5	2
44477-27	24,0	2
44477-28	28,0	2



**Bowl**  
Ciotola  
Schüssel  
Bol  
Bol

art.	Ø cm.	h. cm.	lt.
44477-40	7,5	3,0	0,04
44477-41	7,5	6,5	0,13
44477-44	23,0	3,0	0,40

**Picture/Foto: 44477-24 + 44477-41.**



**Bowl**  
Ciotola  
Schüssel  
Bol  
Bol

art.	dim. cm.	lt.
44477-52	7,5x7,5x3	0,05
44477-53	7,5x7,5x6,5	0,16
44477-54	15,5x15,5x3	0,19
44477-55	15,5x15,5x6,5	0,85



**Bowl**  
Ciotola  
Schüssel  
Bol  
Bol

art.	dim. cm.	lt.
44477-64	15,5x7,5x3	0,10
44477-65	15,5x7,5x6,5	0,40
44477-66	15,5x9,5x3	0,15
44477-67	15,5x9,5x6,5	0,50
44477-68	25x15,5x3	0,30
44477-69	25x15,5x6,5	1,40



**GN**

**Tray**  
Vassoio  
Tablett  
Plateau  
Bandeja

art.	dim. cm.	GN
44477-76	53x32,5x3	1/1
44477-77	32,5x26,5x3	1/2
44477-78	32,5x17,6x3	1/3
44477-79	26,5x16,2x3	1/4
44477-80	35,4x32,5x3	2/3
44477-81	53x16,2x3	2/4

**Picture/Foto: 44477-52, -53, -66, -77.**



**Bowl**  
Ciotola  
Schüssel  
Bol  
Bol

art.	Ø cm.	h. cm.	lt.
41446-18	18	9,5	1,0
41446-23	23	12,5	2,2

**Concrete. – Cemento.**





**Bowl**

Ciotola  
Schüssel  
Bol  
Bol

art.	Ø cm.	h. cm.	lt.
41445-22	22,0	10,5	1,1
41445-26	26,0	13,0	1,7
41445-30	29,5	14,5	2,5

**Concrete. – Cemento.**



**Stand chromed**

Alzata cromata  
Ständer, verchromt  
Support chromé  
Soporte cromado

art.	dim. cm.
44840-50	53x32,5-53x16,5
44840-51	32,5x26,5-26,5x16,2
44840-52	32,5x17,5-35,4x32,5



**Stand**

Alzata  
Ständer  
Support  
Soporte

art.	dim. cm.
44840-55	53x32,5-53x16,5
44840-56	32,5x26,5-26,5x16,2
44840-57	32,5x17,5-35,4x32,5

**Black coating. – Rivestimento nero.**



**Cutting board**

Tagliere  
Schneidebrett  
Planche à découper  
Table de corte

art.	dim. cm.
44840-54	35,4x32,5x3,5

**Walnut/Noce. Fits stands/Per supporti 44840-52 & 44840-57.**



**Drawer with black handle**

Cassetto con pomolo nero  
Schublade, schwarzer Griff  
Tiroir poignée noire  
Cajón con pomo negro

art.	dim. cm.
44840-58	34x32x17,5

**Fits stand 44840-57. – Per supporto 44840-57.**



**Drawer with chrome handle**

Cassetto con pomolo cromato  
Schublade, Chromgriff  
Tiroir poignée chromée  
Cajón con pomo cromado

art.	dim. cm.
44840-53	34x32x17,5

**Fits stand 44840-52. – Per supporto 44840-52.**



**Stand chromed**

Alzata cromata  
Ständer, verchromt  
Support chromé  
Soporte cromado

art.	Ø cm.	h. cm.
44478-77	38,0	16,5
44478-79	48,5	16,5



**Stand chromed**

Alzata cromata  
Ständer, verchromt  
Support chromé  
Soporte cromado

art.	Ø cm.	h. cm.
44478-78	38,0	27
44478-80	48,5	27





**BUFFET**



**Tray**  
Vassoio  
Tablett  
Plateau  
Bandeja

art.	Ø cm.	h. cm.
44478-70	30,0	3
44478-71	38,0	3
44478-72	48,5	3



**Tray**  
Vassoio  
Tablett  
Plateau  
Bandeja

art.	Ø cm.	h. cm.
44478-73	38,0	2,5
44478-74	48,5	2,5



**Intermediate tray**  
Vassoio intermedio  
Zwischenplatte  
Plateau intermédiaire  
Bandeja intermedia

art.	Ø cm.	h. cm.
44478-75	38,0	2,5
44478-76	48,5	2,5



**Stand**  
Alzata  
Ständer  
Support  
Soporte

art.	h. cm.
44840-30	8
44840-31	12
44840-32	18

**Black anti-slip coating.**  
Rivestimento antiscivolo nero.



**Stand**  
Alzata  
Ständer  
Support  
Soporte

art.	Ø cm.	h. cm.
44840-40	15,5-18	8
44840-41	15,5-18	10
44840-42	15,5-18	18

**Black anti-slip coating.**  
Rivestimento antiscivolo nero.





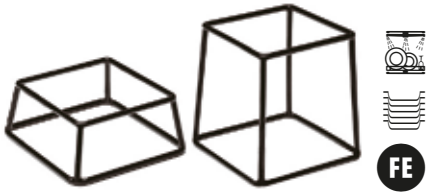

**Stand**  
Alzata  
Ständer  
Support  
Soporte

art.	dim. cm.
44840-08	18x18x8
44840-10	18x18x10
44840-18	18x18x18

**Black anti-slide coating.**  
Rivestimento antiscivolo nero.



**Basket**  
Cesto  
Korb  
Panier  
Cesta

art.	Ø cm.	h. cm.
44476-20	21-16,5	21



**Stand/basket**  
Alzata/cesto  
Ständer/Korb  
Support/panier  
Soporte/cesta

art.	Ø cm.	h. cm.
44476-26	21	10,5
44476-28	21	20,0



**Stand/basket**  
Alzata/cesto  
Ständer/Korb  
Support/panier  
Soporte/cesta

art.	Ø cm.	h. cm.	col.
44476-27	21	10,5	●
44476-29	21	20,0	●



**Stand/basket**  
Alzata/cesto  
Ständer/Korb  
Support/panier  
Soporte/cesta

art.	Ø cm.	h. cm.	col.
44476-51	10,5-8	8	●



**Stand/basket**  
Alzata/cesto  
Ständer/Korb  
Support/panier  
Soporte/cesta

art.	Ø cm.	h. cm.	col.
44476-52	10,5-8	8	●



**Stand/basket**  
Alzata/cesto  
Ständer/Korb  
Support/panier  
Soporte/cesta

art.	Ø cm.	h. cm.	col.
44476-53	10,5-8	8	●



**Stand/basket chromed**  
Alzata/cesto cromato  
Ständer/Korb, verchromt  
Support/panier, chromé  
Soporte/cesta cromado

art.	Ø cm.	h. cm.
44476-30	15	10,5
44476-31	21	20,0



**Stand/basket**  
Alzata/cesto  
Ständer/Korb  
Support/panier  
Soporte/cesta

art.	Ø cm.	h. cm.	col.
44476-32	15	10,5	●
44476-33	21	20,0	●



**Buffet display, 3 pcs set**  
Display per buffet, set 3 pz  
Buffetgestell, 3er Set  
Etagère à buffet, set 3 pcs  
Expositor para buffet, set 3 pz

art.	dim. cm.
41919-03	40x18x4
41919-03	40x20x8
41919-03	40x22x12





**Buffet diplay**

Display per buffet  
Büffetgestell  
Etagère à buffet  
Expositor para buffet

art. dim. cm.  
41870-01 54x47x63

**Shelves/Ripiani: 47x34 - 37x25 - 27x17 - 23x13 cm.**



**Buffet diplay**

Display per buffet  
Büffetgestell  
Etagère à buffet  
Expositor para buffet

art. Ø cm. h. cm.  
41870-03 28 29

**Shelves/Ripiani: 38x30x21 - 38x30x13 - 38x30x5 cm.**



**Buffet diplay**

Display per buffet  
Büffetgestell  
Etagère à buffet  
Expositor para buffet

art. dim. cm.  
41870-02 40x40x53

**Shelves/Ripiani: 40x40 - 30x30 - 22x22 - 27x17 - 23x13 cm.**



**Buffet diplay**

Display per buffet  
Büffetgestell  
Etagère à buffet  
Expositor para buffet

art. dim. cm.  
41870-04 40x27x29

**Shelves/Ripiani: 40x27x21 - 40x27x13 - 40x27x5 cm.**





SS

**Fruit stand, 3 tiers**

Alzata frutta, 3 piani  
Obstständer, 3-stöckig  
Etagère à fruits, 3 étages  
Frutero 3 pisos

art.	Ø cm.	h. cm.
42940-03	32-38-48	50



**Wedding cake stand, aluminum**

Alzata per torte, alluminio  
Hochzeitstortenständer, Aluminium  
Support pour tourte de mariage, alu  
Pedestal para tartas, aluminio

art.	Ø cm.
47100-03	20-26-32
47100-04	20-26-32-40
47100-05	20-26-32-40-45

**Distance between tiers 16,5 cm.**  
Distanziali h. 16,5 cm.



**Wedding cake stand, aluminum**

Alzata per torte, alluminio  
Hochzeitstortenständer, Aluminium  
Support pour tourte de mariage, alu  
Pedestal para tartas, aluminio

art.	Ø cm.
47100-06	20-26-32-40-45-50
47100-07	16-20-26-32-40-45-50
47100-08	16-20-26-32-40-45-50-55

**Distance between tiers 16,5 cm.**  
Distanziali h. 16,5 cm.



SS

**Lightning column**

Colonna luminosa  
Lichtsäule  
Socle lumineux  
Columna luminosa

art.	Ø cm.	h. cm.
42979-00	30	21

**Stainless steel base plate ø30 cm., PMMA column, LED-light box and remote control.**  
Base inox ø cm 30, colonna PMMA, scatola luci-LED con telecomando.



SS

**Oyster plate**

Piatto frutti di mare  
Austernplatte  
Plat à huîtres  
Fuente de mariscos

art.	Ø cm.	h. cm.
42979-36	36	4,5

**The plate has a centering element which keeps it anchored to the column.**



SS

**Oyster plate**

Piatto frutti di mare  
Austernplatte  
Plat à huîtres  
Fuente de mariscos

art.	Ø cm.	h. cm.
42979-45	45	5,5

**Sotto il piatto è fissato un elemento di centraggio che lo mantiene ancorato alla colonna luminosa.**



SS

**Chocolate fountain**

Fontana cioccolato  
Schokoladenbrunnen  
Fontaine à chocolat  
Fuente para chocolate

art.	Ø cm.	h. cm.	lt.	W
42982-08	38	80	3,5	370

**230V-50Hz-Amps 1,6A. Minimum quantity of chocolate necessary for operation is about 3.5 kg, the maximum is 8 kg. –** Quantità minima di cioccolato richiesta per funzionare è di circa 3,5 kg e può contenerne fino a 8 kg.



SS

**Cocktail fountain**

Fontana cocktails  
Cocktails-Laufbrunnen  
Fontaine à cocktails  
Fuente cocktail

art.	Ø cm.	h. cm.	lt.
42981-73	42	56	15

**10W 220V. NOT recommend for use with fizzy drinks or champagne. –** Prodotto NON consigliato per liquidi gasati o champagne.







**Champagne Waterfall**

Cascata champagne  
Sekt Wasserfall  
Cascade à champagne  
Cascada champán

art.	Ø cm.	h. cm.
42980-01	45	64

**LED lighting multicolor cycle. For 42 champagne cups.** – Illuminazione led a ciclo multicolore. Per 42 coppe champagne.



**Champagne Waterfall**

Cascata champagne  
Sekt Wasserfall  
Cascade à champagne  
Cascada champán

art.	Ø cm.	h. cm.
42980-02	45	107

**LED lighting multicolor cycle. For 73 champagne cups.** – Illuminazione led a ciclo multicolore. Per 73 coppe champagne.



**Punch bowl**

Coppa punch  
Punchbowle  
Rafraîchisseur  
Cubitera para champán

art.	Ø cm.	lt.
41541-44	44	15

**Stainless steel bottom ring.** – Piede inox.



**Punch bowl**

Coppa punch  
Punchbowle  
Rafraîchisseur  
Cubitera para champán

art.	Ø cm.	lt.
11956-37	36	9,5
11956-42	42	15,0



**Big party tub**

Secchio portabottiglie  
Flaschenkühler-Bowle  
Rafraîchisseur à bouteilles  
Cubitera enfriador de botellas

art.	dim. cm.
44946-04	40x28x23



**Big party tub**

Secchio portabottiglie  
Flaschenkühler-Bowle  
Rafraîchisseur à bouteilles  
Cubitera enfriador de botellas

art.	dim. cm.
44946B05	35x35x20





ACRYLIC MIRRORS  
SPECCHI ACRILICI PMMA



**Mirror, square**

Specchio quadrato  
Spiegel, quadratisch  
Miroir carré  
Espejo cuadrado

art.	dim. cm.
41885-30	30x30
41885-40	40x40
41885-45	45x45
41885-50	50x50
41885-60	60x60



**Mirror, oval**

Specchio ovale  
Spiegel, oval  
Miroir ovale  
Espejo oval

art.	dim. cm.
41877-45	45x30
41877-61	61x45,5
41877-81	81x61
41877-99	100x70



**Mirror, rectangular**

Specchio rettangolare  
Spiegel, rechteckig  
Miroir rectangulaire  
Espejo rectangular

art.	dim. cm.
41878-45	45x30
41878-61	61x46
41878-81	81x58,5
41878-99	100x70



**Mirror, octagon**

Specchio ottagonale  
Spiegel, achteckig  
Miroir octogonal  
Espejo octogonal

art.	Ø cm.
41879-30	30
41879-40	40
41879-50	50
41879-61	61



**Mirror, hexagon**

Specchio esagono  
Spiegel, Sechseck  
Miroir hexagon  
Espejo hexágono

art.	Ø cm.
41880-38	38
41880-61	61



**Mirror, comma**

Specchio virgola  
Spiegel, Komma  
Miroir virgule  
Espejo vírgula

art.	Ø cm.
41875-40	40,6
41875-61	61,0



**Mirror, segment**

Specchio spicchio  
Spiegel, Segment  
Miroir quartier  
Espejo segmento

art.	Ø cm.
41881-30	30,5
41881-40	40,5



**Mirror, circle**

Specchio cerchio  
Spiegel, Kreis  
Miroir cercle  
Espejo aro

art.	Ø cm.
41876-30	30,5
41876-38	38,0
41876-45	45,0
41876-58	58,0



**Mirror, cube**

Specchio cubo  
Spiegel, Würfel  
Miroir cube  
Espejo cubo

art.	dim. cm.
41882-15	15x15x15
41882-20	20x20x20
41882-25	25x25x25
41882-30	30x30x30





**W**  
**FE**

**Set 2 lanterns**

Set 2 lanternne  
Set 2 laternen  
Set 2 lanternes  
Set 2 linternas

art.	dim. cm.
42440-30	22x20x52 30x26x71



**W**  
**FE**

**Set 2 lanterns**

Set 2 lanternne  
Set 2 laternen  
Set 2 lanternes  
Set 2 linternas

art.	dim. cm.
42441-25	17x17x44 25x25x62



**W**  
**FE**

**Set 2 lanterns**

Set 2 lanternne  
Set 2 laternen  
Set 2 lanternes  
Set 2 linternas

art.	dim. cm.
42442-24	17x17x45 24x24x67



**Set 3 candles**

Set 3 candele  
Kunstkerzen, 3er Set  
Set 3 bougies  
Set 3 velas

art.	Ø cm.	h. cm.
42445-03	9	12,5
	9	18
	9	23

**Resin. Timer function 5 hours ON/19 OFF. Powered by 2D alkaline batteries (not incl.). Working time >800 hours. Flameless moving wick.** – Resina. Funzione timer 5 ore ON/19 OFF. 2 batterie alcaline D (non incluse). Durata > 800 ore. Stoppino mobile senza fiamma.



**Tray stand, chromed**

Stand per vassoi, cromato  
Tablett-Träger, verchromt  
Porte plateaux, chromé  
Soporte para bandejas, cromado

art.	dim. cm.
44093-00	38x48x74



**Tray stand**

Stand per vassoi  
Tablett-Träger  
Porte plateaux  
Soporte para bandejas

art.	dim. cm.
44093-01	42x43x82



**GN**  
**SS**

**Tray**

Vassoio  
Tablett  
Plateau  
Bandeja

art.	dim. cm.	GN
41430-11	53x32,5x5	1/1

**Chrome plated handles. Useful height 4 cm.**  
Maniglie cromate. Altezza utile 4 cm.



SS

**Tray**

Vassoio  
Tablett  
Plateau  
Bandeja

art.	dim. cm.	GN
41436-11	53x32,5	1/1
41436-12	32,5x26,5	1/2



SS

**Fish tray**

Vassoio pesce  
Fischplatte  
Plat à poisson  
Salmonera

art.	dim. cm.
66345-55	55x23
66345-65	65x27
66345-74	74x29



SS

**Fish tray**

Vassoio pesce  
Fischplatte  
Plat à poisson  
Salmonera

art.	dim. cm.
41654-80	80x31
41654-99	100x35



SS

**Tray, oval**

Vassoio ovale  
Tablett, oval  
Plateau ovale  
Bandeja oval

art.	dim. cm.
41651-20	20x14
41651-25	25x18
41651-30	30x22
41651-35	35x22
41651-40	40x26



SS

**Tray, oval**

Vassoio ovale  
Tablett, oval  
Plateau ovale  
Bandeja oval

art.	dim. cm.
41651-45	45x29
41651-50	50x35
41651-55	55x38
41651-60	60x42
41651-65	65x45



SS

**Tray, round**

Vassoio tondo  
Tablett, rund  
Plateau rond  
Bandeja redonda

art.	Ø cm.
66326-30	30
66326-35	35
66326-40	40
66326-60	60
66326-80	80



SS

**Tray, oval**

Vassoio ovale  
Tablett, oval  
Plateau ovale  
Bandeja oval

art.	dim. cm.
66325-30	30x19
66325-35	35x22
66325-41	41x26
66325-46	46x29
66325-54	54x37
66325-85	85x58
66325-99	100x68



SS

**Tray, rectangular**

Vassoio rettangolare  
Servierblett, rechteckig  
Plateau rectangulaire  
Bandeja rectangular

art.	dim. cm.
66320-28	28x20
66320-35	35x30
66320-40	40x26
66320-50	50x38
66320-65	65x50
66320-85	85x50
66320-99	100x50



SS

**Tray, rectangular**

Vassoio rettangolare  
Servierblett, rechteckig  
Plateau rectangulaire  
Bandeja rectangular

art.	dim. cm.
66324-40	40x26
66324-50	50x38
66324-65	65x50
66324-85	85x50
66324-99	100x50







ACACIA WOOD for a multifunctional buffet system that adapts in height and width to all space requirements. The stackable and non-slip reversible boxes can be used individually or connected with flat GN trays.

LEGNO DI ACACIA per un sistema multifunzionale che si adatta in altezza e larghezza a tutte le esigenze di spazio. Le scatole reversibili, impilabili e antiscivolo possono essere utilizzate singolarmente o collegate con i piani GN.



**Box**  
Scatola  
Wendebox  
Boîte  
Caja

art.	dim. cm.	GN
42463A02	55,5x35x10,5	1/1



**Box**  
Scatola  
Wendebox  
Boîte  
Caja

art.	dim. cm.	GN
42463A04	55,5x18,5x10,5	2/4



**Box**  
Scatola  
Wendebox  
Boîte  
Caja

art.	dim. cm.	GN
42463A05	35x29x10,5	1/2



**Box**  
Scatola  
Wendebox  
Boîte  
Caja

art.	dim. cm.	GN
42463A08	29x18,5x10,5	1/4



**Box**  
Scatola  
Wendebox  
Boîte  
Caja

art.	dim. cm.	GN
42463B02	55,5x35x10,5	1/1



**Box**  
Scatola  
Wendebox  
Boîte  
Caja

art.	dim. cm.	GN
42463B04	55,5x18,5x10,5	2/4





**Box**  
Scatola  
Wendebox  
Boîte  
Caja

art.	dim. cm.	GN
42463B05	35x29x10,5	1/2



**Box**  
Scatola  
Wendebox  
Boîte  
Caja

art.	dim. cm.	GN
42463B08	29x18,5x10,5	1/4



**Bread slicer**  
Taglia pane  
Brottschneidgerät  
Coupe-pain  
Corta-pan

art.	dim. cm.
49833-00	41x15x10

W



**Bread box**  
Cesto pane  
Brotkiste  
Caisse à pain  
Cajón para pan

art.	dim. cm.
42874-01	34x26x12,5
42874-02	34x26x20

Beech wood. – Faggio.



W



**Bread cutting board**  
Tagliere  
Brottschneidbrett  
Planche à découper  
Tabla de corte

art.	dim. cm.
42874-03	52x34x2

Beech wood. – Faggio.



W



**Cutting board tray**  
Vassoio per tagliere  
Schneidbrett-Tablett  
Plateau pour planche à découper  
Bandeja para tabla de corte

art.	dim. cm.
42874-04	60x35,5x3,5



MF





**W**

**Pretzel stand**

Porta Brezel  
Brezel-ständer  
Support à brezel  
Soporte para brezel

art.      Ø cm.    h. cm.  
42870-50    22      50

**Beechwood.** – Faggio.



**AY**

**Hygienic cover**

Copertura igienica  
Hygieneschutz  
Couverture d'hygiène  
Cobertura d'higiene

art.      dim. cm.  
42870-51    20x20x50



**AY**

**SS**

**Bread roll-dispenser**

Distributore panini  
Brötchen-Spender  
Distributeur à pain  
Dispensador de pan

art.      dim. cm.  
42963-55    32x22x55

**For/Per: 65-70 pcs.**



**PP**

**Bread basket**

Cesto pane  
Brotkorb  
Corbeille à pain  
Cesta pan

art.	dim. cm.	GN	col.
42462-11	53x32,5x6,5	1/1	●
42462-12	32,5x26,5x6,5	1/2	●
42462-13	32,5x17,5x6,5	1/3	●
42462-14	26,4x16,2x6,5	1/4	●
42462-16	17,6x16,2x6,5	1/6	●
42462-23	32,5x35,4x6,5	2/3	●



**PP**

**Bread basket**

Cesto pane  
Brotkorb  
Corbeille à pain  
Cesta pan

art.	dim. cm.	GN	col.
42463-11	53x32,5x10	1/1	●
42463-12	32,5x26,5x10	1/2	●
42463-13	32,5x17,5x10	1/3	●
42463-14	26,4x16,2x10	1/4	●
42463-16	17,6x16,2x10	1/6	●
42463-23	32,5x35,4x10	2/3	●



**PP**

**Bread basket**

Cesto pane  
Brotkorb  
Corbeille à pain  
Cesta pan

art.	dim. cm.	GN	col.
42967-63	53x32,5x6,5	1/1	●
42967-64	32,5x26,5x6,5	1/2	●
42967-65	32,5x17,5x6,5	1/3	●
42967-66	26,4x16,2x6,5	1/4	●
42967-67	17,6x16,2x6,5	1/6	●
42967-68	32,5x35,4x6,5	2/3	●



**PP**

**Bread basket**

Cesto pane  
Brotkorb  
Corbeille à pain  
Cesta pan

art.	dim. cm.	GN	col.
42967-73	53x32,5x10	1/1	●
42967-74	32,5x26,5x10	1/2	●
42967-75	32,5x17,5x10	1/3	●
42967-76	26,4x16,2x10	1/4	●
42967-77	17,6x16,2x10	1/6	●
42967-78	32,5x35,4x10	2/3	●



**Bread basket**

Cesto pane  
Brotkorb  
Corbeille à pain  
Cesta pan

art.	dim. cm.	GN	col.
42967-03	53x32,5x6,5	1/1	●
42967-04	32,5x26,5x6,5	1/2	●
42967-05	32,5x17,5x6,5	1/3	●
42967-06	26,4x16,2x6,5	1/4	●
42967-07	17,6x16,2x6,5	1/6	●
42967-08	32,5x35,4x6,5	2/3	●

**Bread basket**

Cesto pane  
Brotkorb  
Corbeille à pain  
Cesta pan

art.	dim. cm.	GN	col.
42967-13	53x32,5x10	1/1	●
42967-14	32,5x26,5x10	1/2	●
42967-15	32,5x17,5x10	1/3	●
42967-16	26,4x16,2x10	1/4	●
42967-17	17,6x16,2x10	1/6	●
42967-18	32,5x35,4x10	2/3	●



**Bread basket**

Cesto pane  
Brot-Korb  
Corbeille à pain  
Cesta pan

art.	dim. cm.	h. cm.
42973-45	45x40	16/27
42973-61	divider	



**Bread basket**

Cesto pane  
Brot-Korb  
Corbeille à pain  
Cesta pan

art.	dim. cm.	h. cm.
42973-60	60x40	16/27



**French stick bread basket**

Cesta baguettes  
Brotkorb für Baguette  
Corbeille à baguettes  
Cesta pan francés

art.	Ø cm.	h. cm.
42967-35	35	25/42

**French stick bread basket**

Cesta baguettes  
Brotkorb für Baguette  
Corbeille à baguettes  
Cesta pan francés

art.	Ø cm.	h. cm.
42972-28	30	38



**Bread basket**

Cesto pane  
Brotkorb  
Corbeille à pain  
Cesta pan

art.	Ø cm.	h. cm.
42968-38	38	10







**Bread basket**

Cesto pane  
Brotkorb  
Corbeille à pain  
Cesta pan

art.	Ø cm.	h. cm.
42968-42	42	12



**Bread basket**

Cesto pane  
Brotkorb  
Corbeille à pain  
Cesta pan

art.	Ø cm.	h. cm.
42969-31	31/37	6/12



**Bread basket**

Cesto pane  
Brotkorb  
Corbeille à pain  
Cesta pan

art.	Ø cm.	h. cm.
42969-36	36,5	12



**Bread basket**

Cesto pane  
Brotkorb  
Corbeille à pain  
Cesta pan

art.	dim. cm.	h. cm.
42967-43	45x42	17/24



**Bread basket**

Cesto pane  
Brotkorb  
Corbeille à pain  
Cesta pan

art.	dim. cm.
42972-01	40x20x5
42972-02	40x30x5
42972-03	60x20x5
42972-04	60x40x5



**Bread basket**

Cesto pane  
Brotkorb  
Corbeille à pain  
Cesta pan

art.	dim. cm.
42967-53	53x32,5x15,5



**Bread basket**

Cesto pane  
Brotkorb  
Corbeille à pain  
Cesta pan

art.	dim. cm.
42936-23	23x19x9



**Bread basket**

Cesto pane  
Brotkorb  
Corbeille à pain  
Cesta pan

art.	dim. cm.
42936-24	24x17x8
42936-28	28x16x8,5



**Bread basket**

Cesto pane  
Brotkorb  
Corbeille à pain  
Cesta pan

art.	dim. cm.
42946-23	23x10x6
42946-37	37,5x15x7



**Bread basket**

Cesto pane  
Brotkorb  
Corbeille à pain  
Cesta pan

art.	dim. cm.
42947-23	23x15x7
42947-30	30x22x7
42947-40	41x29x7



**Bread basket**

Cesto pane  
Brotkorb  
Corbeille à pain  
Cesta pan

art.	dim. cm.	GN
42969-11	53,5x32,5x9,5	1/1



**Bread basket**

Cesto pane  
Brotkorb  
Corbeille à pain  
Cesta pan

art.	dim. cm.	GN
42965-12	32,5x26,5x8	1/2







**Bread basket**

Cesto pane  
Brotkorb  
Corbeille à pain  
Cesta pan

art. dim. cm. GN  
42967-11 56,5x36x10 1/1

**With frame to fix the cover.**  
Con telaio per fissare il coperchio.



**Roll-top cover**

Coperchio roll-top  
Rolltophaube  
Couvercle roll-top  
Tapa roll-top

art. dim. cm. GN  
41415-11 53x32,5x17 1/1

**Chrome knob. – Pomolo cromato.**



**Bread basket**

Cesto pane  
Brotkorb  
Corbeille à pain  
Cesta pan

art. dim. cm. GN  
42461-11 56,5x36x10 1/1

**With frame to fix the cover.**  
Con telaio per fissare il coperchio.



**Roll-top cover**

Coperchio roll-top  
Rolltophaube  
Couvercle roll-top  
Tapa roll-top

art. dim. cm. GN  
42452-53 53x32,5x17 1/1

**Chrome knob. – Pomolo cromato.**



**Bread basket**

Cesto pane  
Brotkorb  
Corbeille à pain  
Cesta pan

art. Ø cm. h. cm.  
42461-35 35 20

**With frame to fix the cover.**  
Con telaio per fissare il coperchio.



**Roll-top cover**

Coperchio roll-top  
Rolltophaube  
Couvercle roll-top  
Campana roll-top

art. Ø cm. h. cm.  
42452-35 38 20



**Cover**

Coperchio  
Kuppelhaube  
Couvercle  
Campana

art. dim. cm. GN  
41419-12 33x28x17 1/2

**One front cut. – Con apertura frontale.**



**Cover**

Coperchio  
Kuppelhaube  
Couvercle  
Campana

art. dim. cm. GN  
41418-11 54x33x20 1/1

**One front cut. – Con apertura frontale.**



**Cover**

Coperchio  
Kuppelhaube  
Couvercle  
Campana

art. dim. cm. GN  
41418-12 54x33x20 1/1

**Totally closed. – Chiuso.**



**Bread basket**

Cesto pane  
Brotkorb  
Corbeille à pain  
Cesta pan

art. dim. cm. col.  
42991-25 25x19x6,5 ●  
42991-32 32x23x7 ●



**Bread basket**

Cesto pane  
Brotkorb  
Corbeille à pain  
Cesta pan

art. dim. cm. col.  
42991M25 25x19x6,5 ●  
42991M32 32x23x7 ●



**Bread basket**

Cesto pane  
Brotkorb  
Corbeille à pain  
Cesta pan

art. dim. cm. col.  
42991N25 25x19x6,5 ●  
42991N32 32x23x7 ●





**Bread basket**

Cesto pane  
Brotkorb  
Corbeille à pain  
Cesta pan

art.	dim. cm.	col.
42993-40	40X30X10	●
42993M40	40X30X10	●
42993N40	40X30X10	●



**Bread basket**

Cesto pane  
Brotkorb  
Corbeille à pain  
Cesta pan

art.	Ø cm.	h. cm.	col.
42990-16	16	8	●
42990-20	20	8	●
42990-29	29	7	●



**Bread basket**

Cesto pane  
Brotkorb  
Corbeille à pain  
Cesta pan

art.	Ø cm.	h. cm.	col.
42990M16	16	8	●
42990M20	20	8	●
42990M29	29	7	●



**Bread basket**

Cesto pane  
Brotkorb  
Corbeille à pain  
Cesta pan

art.	Ø cm.	h. cm.	col.
42990N16	16	8	●
42990N20	20	8	●
42990N29	29	7	●



**Bread basket stand**

Alzata ceste  
Körbe-Gestell  
Étagère à corbeilles  
Soporte ceste pan

art.	dim. cm.
42870-59	30,5x59x58

**For baskets 42968-38 and 42967-13.**  
Per cesti 42968-38 e 42967-13.



**Wire stand chrome plated, 2 tiers**

Supporto filo cromato, 2 piani  
Brotkorb-Drahtgestell, Doppeldecker  
Support en fil chromé, 2 étages  
Estructura alambre cromado, 2 alturas

art.	dim. cm.	GN
42872-02	46x24x21	1/2

**For baskets/Per cesti:**  
**42965-12, 42967- 04-14-64-74.**



**Wire stand black, 2 tiers**

Supporto filo nero, 2 piani  
Brotkorb-Drahtgestell, Doppeldecker  
Support en fil noir, 2 étages  
Estructura alambre negro, 2 alturas

art.	dim. cm.	GN
41220-06	44,5x26x22	1/2



**Basket with black wire stand**

Cesto con supporto filo nero  
Korbdrahtgestell, schwarz  
Panier support en fil noir  
Cesta estructura alambre negro

art.	dim. cm.
41220-02	40x30
41220-03	60x40

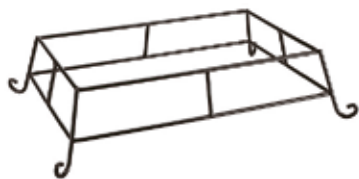

**Wire stand black**

Supporto filo nero  
Drahtgestell, schwarz  
Support en fil noir

Estructura alambre negro

art.	dim. cm.	GN
41220-07	49,5x30x13,5	1/1



PP

**Basket with black wire stand**

Cesto con supporto filo nero  
Korbdrahtgestell, schwarz  
Panier support en fil noir

Cesta estructura alambre negro

art.	Ø cm.	h. cm.
41220-01	38	15,5



PP

**Basket with black wire stand**

Cesto con supporto filo nero  
Korbdrahtgestell, schwarz  
Panier support en fil noir

Cesta estructura alambre negro

art.	Ø cm.	h. cm.
41220-04	33	15,5



PP

**Basket with black wire stand**

Cesto con supporto filo nero  
Korbdrahtgestell, schwarz  
Panier support en fil noir

Cesta estructura alambre negro

art.	Ø cm.	h. cm.
41220-05	43	15,5



**Round canvas bag**

Cesto cotone, rotondo  
Brottasche, rund, Baumwolle  
Panier à pain, coton

Cesta pan, algodón

art.	Ø cm.	h. cm.	col.
42873-02	20	23,5	●

**Stone pillow included. Easy to heat up in microwave for 90 sec. at 500 Watt. Machine washable up to 30°C (except pillow).**

Cuscino noccioli di ceramica incluso. Scaldare in microonde per 90 secondi a 500 Watt. Lavabile in lavatrice max 30°C (escluso cuscino).



R

**Egg basket, keeps warm**

Cesto uova, imbottito  
Eier-Korb, hält warm  
Panier à oeufs, fourré  
Cesta para huevos

art.	Ø cm.	h. cm.
42949-26	26	17

For around 20 eggs. – Per c.ca 20 uova.



**Sign holders, chromed**

Clip flessibili, cromate  
Schildhalter, verchromt  
Porte-étiquettes, chromés  
Porta etiquetas con clip, cromate

art.	l. cm.	pcs/pz
41394-02	12	2



**Chalkmarker**

Penna a gesso liquido  
Kreidestifte  
Stylo à craie liquide  
Rotulador de tiza líquida

art.	Ø mm.	col.
47832-00	5	○
47832-01	5	●
47832-02	5	●
47832-03	5	●
47832-04	5	●
47832-05	5	●

**Clean with water. Writes on all non porous surfaces. – Pulire con acqua. Scrive su tutte le superfici non porose.**





**Chalkmarker**

Penna a gesso liquido

Kreidestifte

Stylo à craie liquide

Rotulador de tiza líquida

art.	Ø mm.	col.
47832-10	15	○
47832-11	15	●
47832-12	15	●
47832-13	15	●
47832-14	15	●
47832-15	15	●



W  
SAN  
SS

**Showplate, 3-pcs set**

Vetrina, set 3 pezzi

Buffetvitrine, 3-teilig

Etagère, set 3 pièces

Vitrina, 3 elementos

art.	Ø cm.	h. cm.
41429-04	45	24



SAN

**Roll-top cover**

Coperchio roll-top

Rolltophaube

Couvercle roll-top

Campana roll-top

art.	Ø cm.	h. cm.
41447-38	38	20

Chrome knob. – Pomolo cromato.



SAN  
SS

**Showplate, 2-pcs set**

Vetrina, set 2 pezzi

Buffetvitrine, 2-teilig

Etagère, set 2 pièces

Vitrina, 2 elementos

art.	Ø cm.	h. cm.
41447-02	38	21



❄️  
SAN  
SS

**Showplate, 5-pcs set**

Vetrina, set 5 pezzi

Buffetvitrine, 5-teilig

Etagère, set 5 pièces

Vitrina, 5 elementos

art.	Ø cm.	h. cm.
41447-05	38	24



❄️  
W  
SAN  
SS

**Showplate, 3-pcs set**

Vetrina, set 3 pezzi

Buffetvitrine, 3-teilig

Etagère, set 3 pièces

Vitrina, 3 elementos

art.	Ø cm.	h. cm.
41905-38	43	4,5

Roll-top 41447-38 not included.

Coperchio 41447-38 non incl.



❄️  
SAN  
SS

**Showcase, 3-pcs set**

Vetrina, set 3 pezzi

Buffetvitrine, 3-teilig

Etagère, set 3 pièces

Vitrina, 3 elementos

art.	Ø cm.	h. cm.	col.
41944-06	38	6	○
41944B06	38	6	●



SAN

**Roll-top cover**

Coperchio roll-top

Rolltophaube

Couvercle roll-top

Campana roll-top

art.	Ø cm.	h. cm.
41945-38	38	20





PC

**Roll-top cover**  
Coperchio roll-top  
Rolltophaube  
Couvercle roll-top  
Campana roll-top

art. dim. cm. GN  
41415-10 53x32,5x17 1/1

**Gold plated knob. – Barretta dorata.**



PC

**Roll-top cover**  
Coperchio roll-top  
Rolltophaube  
Couvercle roll-top  
Campana roll-top

art. dim. cm. GN  
41415-11 53x32,5x17 1/1

**Chrome knob. – Pomolo cromato.**



SS

**Showplate, 4-pcs set**  
Vetrina, set 4 pezzi  
Buffetvitrine, 4-teilig  
Etagère, set 4 pièces  
Vitrina, 4 elementos

art. dim. cm. GN  
41907-56 56,5x36x8,5 1/1

**Box + tray GN 1/1 + 2 cooler, without rolltop cover  
41415-11. – Base + vassoio + 2 eutettici, coperchio  
41415-11 non incl.**



W

**Showplate, 4-pcs set**  
Vetrina, set 4 pezzi  
Buffetvitrine, 4-teilig  
Etagère, set 4 pièces  
Vitrina, 4 elementos

art. dim. cm.  
41906-60 60x41x5

**Box + tray GN 1/1 + 2 cooler, without rolltop cover  
41415-11. – Base + vassoio + 2 eutettici, coperchio  
41415-11 non incl.**



W

PP

PS

**Ice-box, 3 pcs set**  
Box portaghiaccio, set 3 pz  
Eisbox, 3-teilig  
Boîte à glaçons, 3 pièces  
Cubitera, 3 elementos

art. dim. cm.  
41412-11 53x32,5x12,5

**Box wenge + plastic deep tray + drainer plate.**  
Base wengé + vasca plastica + griglia.



SS

**Showplate, 4-pcs set**  
Vetrina, set 4 pezzi  
Buffetvitrine, 4-teilig  
Etagère, set 4 pièces  
Vitrina, 4 elementos

art. dim. cm. col.  
41940-06 43,5x32,5x6 ○  
41940B06 43,5x32,5x6 ●

**Box, tray, 2 coolers.**  
Contenitore, vassoio, 2 eutettici.



SAN

**Roll-top cover**  
Coperchio roll-top  
Rolltophaube  
Couvercle roll-top  
Campana roll-top

art. dim. cm.  
41941-44 44x33,5x17

**For showcases 419040-06, 41940B06.**  
Per vetrine 41940-06, 41940B06.



W

**Cutting board**  
Tagliere  
Schneidebrett  
Planche à découper  
Tabla de corte

art. dim. cm.  
41941-43 43,5x32,5x2

**For showcases 419040-06, 41940B06.**  
Per vetrine 41940-06, 41940B06.

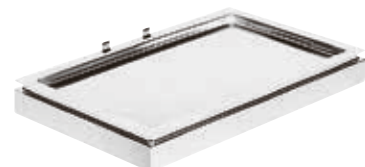

SS

**Cool plate**  
Vetrina refrigerata  
Buffet-Vitrine, kühlbar  
Vitrine réfrigérée  
Vitrina refrigerada

art. dim. cm. GN  
42450-00 53x32,5x8,5 1/1

**GN 1/1 base element, s/s platter, cooler.**  
Base GN 1/1, vassoio inox, eutettico.



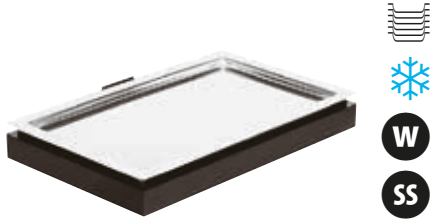

**Cool plate**

Vetrina refrigerata  
Büffet-Vitrine, kühlbar  
Vitrine réfrigérée  
Vitrina refrigerada

art. dim. cm. GN  
42460-00 53x32,5x8,5 1/1

**GN 1/1 base element, s/s platter, cooler.**  
Base GN 1/1, vassoio inox, eutettico.



**Cool plate**

Vetrina refrigerata  
Büffet-Vitrine, kühlbar  
Vitrine réfrigérée  
Vitrina refrigerada

art. dim. cm. GN  
42470-00 53x32,5x8,5 1/1

**GN 1/1 base element, s/s platter, cooler.**  
Base GN 1/1, vassoio inox, eutettico.



**Eutectic pad**

Accumulatore di freddo  
Kühlakku  
Cartouche eutectique  
Placa eutética

art. dim. cm.  
42450-AD 41x21x2,5



**GN roll-top cover**

Coperchio GN roll-top  
GN-Rolltophaube  
Couvercle roll-top, GN  
Tapa roll-top, GN

art. GN  
42452-53 1/1



**Tray**

Vassoio  
Tablett  
Plateau  
Bandeja

art. GN  
42451-11 1/1  
42451-12 1/2



**Cutting board**

Tagliere  
Tranchierbrett  
Planche à découper  
Plancha para cortar

art. GN  
42470-06 1/1



**Cutting board**

Tagliere  
Tranchierbrett  
Planche à découper  
Plancha para cortar

art. GN  
42460-06 1/1



**Cooled buffet showcase**

Vetrina refrigerata  
Büffet-Vitrine, kühlbar  
Vitrine réfrigérée  
Vitrina refrigerada

art. dim. cm. col.  
42470-63 63,5x42,5x31 ●

**Woodabse with fixed roll-top cover, plastic case, GN 1/1 melamine tray, cooling unit.** – Base legno con coperchio roll-top fisso, vasca plastica, GN 1/1 in melamina, placca eutettica.



**Cooled buffet showcase**

Vetrina refrigerata  
Büffet-Vitrine, kühlbar  
Vitrine réfrigérée  
Vitrina refrigerada

art. dim. cm. col.  
42460-63 63,5x42,5x31 ●

**Woodabse with fixed roll-top cover, plastic case, GN 1/1 melamine tray, cooling unit.** – Base legno con coperchio roll-top fisso, vasca plastica, GN 1/1 in melamina, placca eutettica.



**Cutlery dispenser**

Portaposate  
Besteck-Behälter  
Bac à couverts  
Caja portacubiertos

art. dim. cm. col.  
42470-64 57,5x37x12 ●



**Cutlery dispenser**

Portaposate  
Besteck-Behälter  
Bac à couverts  
Caja portacubiertos

art. dim. cm. col.  
42460-64 57,5x37x12 ●



**Bowl**

Ciotola  
Schüssel  
Bol  
Bol

art.	Ø cm.	h. cm.	lt.	col.
44837B05	14	6,5	0,5	●
44837B20	20	9,2	1,8	●
44837B25	23	10,0	2,5	●



MF

**Bowl**

Ciotola  
Schüssel  
Bol  
Bol

art.	Ø cm.	h. cm.	lt.	col.
44837-05	14	6,5	0,5	○
44837-20	20	9,2	1,8	○
44837-25	23	10,0	2,5	○



**Bowl, glass**

Ciotola, vetro  
Glasschüssel  
Bol en verre  
Bol vidrio

art.	Ø cm.	h. cm.	lt.
41425-AA	7,5	3,5	0,09
41405-AA	14,0	6,5	0,5
41400-AA	23,0	10,0	2,5



PC

**Airtight cover**

Coperchio ermetico  
Frischhaltedeckel  
Couvercle hermétique  
Tapa hermética

art.	Ø cm.
42452-14	14
42452-23	23



PC

**Cover**

Coperchio  
Deckel  
Couvercle  
Tapa

art.	Ø cm.
42453-23	23



SAN

**Cover**

Coperchio  
Deckel  
Couvercle  
Tapa

art.	Ø cm.
44837C20	20,5

Matches/Per: 44837-20 & 44837B20.



W

W

**Cool bowl**

Ciotola refrigerata  
Kühlschale  
Bol réfrigérée  
Bol refrigerda

art.	dim. cm.	lt.	col.
42470-27	27,5x27,5x14	2,5	●

Wood base, s/s container, melamine bowl, cooling unit. – Base legno, contenitore inox, ciotola melamina, placca eutettica.



W

W

**Cool bowl**

Ciotola refrigerata  
Kühlschale  
Bol réfrigérée  
Bol refrigerda

art.	dim. cm.	lt.	col.
42460-27	27,5x27,5x14	2,5	●

Wood base, s/s container, melamine bowl, cooling unit. – Base legno, contenitore inox, ciotola melamina, placca eutettica.





AY

PC

SS

**Cool bowl**

Ciotola refrigerata  
Kühlschale  
Bol réfrigérée  
Bol refrigerda

art.	Ø cm.	h. cm.	lt.
41448-06	14	9,0	0,6
41448-10	14	11,5	1,0

**Base + cooler + bowl + cover.**  
Base + eutettico + ciotola + coperchio.



AY

PC

SS

**Cool bowl**

Ciotola refrigerata  
Kühlschale  
Bol réfrigérée  
Bol refrigerda

art.	Ø cm.	h. cm.	lt.
41448-25	22	14	2,5
41448-40	22	18	4,0

**Base + cooler + bowl + cover.**  
Base + eutettico + ciotola + coperchio.



**Buffet stand, chrome plated**

Alzata, cromata  
Buffet-Gestell, Metall hartverchromt  
Présentoir, chromé  
Soporte, cromado

art.	dim. cm.
41442-03	61x24x35

**3 glass bowls ø cm 23 + 3 covers.**  
3 ciotole ø cm 23 + covers.



**Serving stand, chrome plated**

Supporto cromato  
Serviergestell, hartverchromt  
Présentoir, acier chromé  
Soporte platos, acero cromado

art.	dim. cm.
44840-06	39x39x17

**For bowls/Per ciotole: 12,5x12,5 e 25x25 cm.**



**Serving stand, chrome plated**

Supporto cromato  
Serviergestell, hartverchromt  
Présentoir, acier chromé  
Soporte platos, acero cromado

art.	dim. cm.
44840-07	55,5x19x15,5

**For bowls 19x19 cm. NOT included.**  
Per ciotole 19x19 cm. NON include.



MF

**Bowl**

Ciotola  
Schüssel  
Bol  
Bol

art.	dim. cm.
44884-12	12,5x12,5x6
44884-19	19x19x9,5
44884-25	25x25x12



MF

**Bowl**

Ciotola  
Schüssel  
Bol  
Bol

art.	dim. cm.
44884B12	12,5x12,5x6
44884B19	19x19x9,5
44884B25	25x25x12



SAN

**Cover**

Coperchio  
Deckel  
Couvercle  
Tapa

art.	dim. cm.
44885-19	19x19
44885-25	25x25





**Buffet stand, chrome plated**  
Alzata, cromata  
Buffet-Gestell, Metall hartverchromt  
Présentoir, chromé  
Soporte, cromado

art.	dim. cm.
41442-14	30x30x14

**3 glass bowls ø cm 14 + 3 covers.**  
3 ciotole ø cm 14 + covers.



**Buffet stand, chrome plated**  
Alzata, cromata  
Buffet-Gestell, Metall hartverchromt  
Présentoir, chromé  
Soporte, cromado

art.	dim. cm.
41442-23	50x50x18

**3 glass bowls ø cm 23 + 3 covers.**  
3 ciotole ø cm 23 + covers.



**Bowl holder, chromed**  
Portaciotole, cromato  
Schalenhalter, Metall hartverchromt  
Étagère à bols, chromée  
Soporte para bols, cromado

art.	Ø cm.	h. cm.
41427-40	18	25,5

**For 36 bowls ø cm 7 # 41425-AA.**  
Per 36 ciotoline ø cm 7 # 41425-AA.



**Serving stand, chrome plated**  
Alzata, cromata  
Serviergestell, Metall hartverchromt  
Présentoir, chromé  
Soporte platos para buffet, cromado

art.	Ø cm.	h. cm.
42962-04	34	37

**For 4 plates max. Ø 31 cm, inside Ø 23,5 cm.**



**Serving stand, chrome plated**  
Alzata, cromata  
Serviergestell, Metall hartverchromt  
Présentoir, chromé  
Soporte platos, cromado

art.	dim. cm.	col.
42962C26	18,5x15,5x26	●
42962C44	29x19,5x43	●

**26: for 3 plates max. Ø 17 cm, inside Ø 10,5 cm**  
**44: for 3 plates max. Ø 27 cm, inside Ø 18 cm**



**Serving stand**  
Alzata  
Serviergestell  
Présentoir  
Soporte platos

art.	dim. cm.
42962-26	18,5x15,5x26
42962-30	29x19,5x30
42962-44	29x19,5x43

**26: for 3 plates max. Ø 17 cm, inside Ø 10,5 cm**  
**30: for 2 plates max. Ø 27 cm, inside Ø 18 cm**  
**44: for 3 plates max. Ø 27 cm, inside Ø 18 cm**



**Plate cover**  
Copripiatto  
Tellerabdeckhaube  
Cloche  
Cubreplatos

art.	Ø cm.	h. cm.	fits/per
44991-24	24	7,5	Ø 22,5-23

**NEW**

**SAN**



**Fruit stand**  
Espositore porta frutta  
Obstspender  
Étagère à fruits  
Expositor frutas

art.	Ø cm.	h. cm.
41449-27	27,5	32

**FE**

**SS**





FE

SS

**Fruit stand**

Espositore porta frutta  
Obstspender  
Etagère à fruits  
Expositor frutas

art.	Ø cm.	h. cm.
41449-32	32	53



SS

**Fruit stand**

Alzata Royale  
Obstständer  
Etagère Royale  
Expositor de frutas

art.	Ø cm.	h. cm.
41820-03	24-33-42	50



**Buffet ladder, chrome plated**

Espositore buffet, cromato  
Büffet-Leiter, verchromt  
Escalier à buffet, chromé  
Escalera para buffet, cromada

art.	dim. cm.
41912-03	30x30x48

**With 4 bowls ø cm 14 + lids.**  
Con 4 ciotole ø cm 14 + coperchi.



**Buffet ladder, chrome plated**

Espositore buffet, cromato  
Büffet-Leiter, verchromt  
Escalier à buffet, chromé  
Escalera para buffet, cromada

art.	dim. cm.
41912-04	30x30x48

**With 6 bowls ø cm 14.** – Con 6 ciotole ø cm 14.



**Buffet ladder, chrome plated**

Espositore buffet, cromato  
Büffet-Leiter, verchromt  
Escalier à buffet, chromé  
Escalera para buffet, cromada

art.	dim. cm.
41913-03	39x31x66

**With 4 bowls ø cm 23 + lids.**  
Con 4 ciotole ø cm 23 + coperchi.



**Buffet ladder, chrome plated**

Espositore buffet, cromato  
Büffet-Leiter, verchromt  
Escalier à buffet, chromé  
Escalera para buffet, cromada

art.	dim. cm.
41913-04	39x31x66

**With 6 bowls ø cm 23.** – Con 6 ciotole ø cm 23.



**Buffet ladder, chrome plated**

Espositore buffet, cromato  
Büffet-Leiter, verchromt  
Escalier à buffet, chromé  
Escalera para buffet, cromada

art.	dim. cm.	GN
41403-01	31,5x32x48	1/3

**For GN pans see pages 72-73.**  
Per contenitori GN vedi pagg 72-73.



**Buffet ladder, chrome plated**

Espositore buffet, cromato  
Büffet-Leiter, verchromt  
Escalier à buffet, chromé  
Escalera para buffet, cromada

art.	dim. cm.	GN
41403-02	31,5x41,5x48	1/2

**For baskets see pages 422/423.**  
Per cesti vedi pagg 422-423.



**Buffet ladder, chrome plated**

Espositore buffet, cromato  
Büffet-Leiter, verchromt  
Escalier à buffet, chromé  
Escalera para buffet, cromada

art. dim. cm. GN  
41403-03 31,5x56x66 1/2

**For baskets see pages 422/423.**  
Per cesti vedi pagg 422-423.



**Buffet ladder, chrome plated**

Espositore buffet, cromato  
Büffet-Leiter, verchromt  
Escalier à buffet, chromé  
Escalera para buffet, cromada

art. dim. cm. GN  
41403-04 52x59x66 1/1

**For GN pans see pages 72-73.**  
Per contenitori GN vedi pagg 72-73.



**Multi rack**

Multi-distributore  
Multi Rack  
Distributeur  
Dispensador

art. dim. cm.  
41908-01 26x18x43



**Multi rack**

Multi-distributore  
Multi Rack  
Distributeur  
Dispensador

art. dim. cm.  
41908-00 26x18x43



**Multi rack**

Multi-distributore  
Multi Rack  
Distributeur  
Dispensador

art. dim. cm.  
41911-02 19x24x28



**Multi rack**

Multi-distributore  
Multi Rack  
Distributeur  
Dispensador

art. dim. cm.  
41911-03 19x24x41





**SAN**  
**SS**

**Multi rack**  
Multi-distributore  
Multi Rack  
Distributeur  
Dispensador

art. dim. cm.  
41911-04 19x24x53

**For additional canisters and slide see page 527.**  
Per contenitori supplementari e scivolo vedi pag 527.



**W**

**Buffet stand**  
Espositore buffet  
Buffetgestell  
Présentoir  
Expositor de buffet

art. dim. cm.  
42460-53 53x21x50

**Shelves/Ripiani: 30 x 15 - 40 x 17,5 - 53 x 19 cm.**



**W**

**Buffet stand**  
Espositore buffet  
Buffetgestell  
Présentoir  
Expositor de buffet

art. dim. cm.  
42470-53 53x21x50

**Shelves/Ripiani: 30 x 15 - 40 x 17,5 - 53 x 19 cm.**



**W**  
**AR**

**Serving stand 2-tier**  
Alzata 2 piani  
Servierstand 2-stufig  
Support 2 niveaux  
Soporte 2 pisos

art. dim. cm.  
41207-02 25x4,5x34,5

**Beech. Slate cm. 31x13 - 41x18.**  
Faggio. Ardesia cm. 31x13 - 41x18.



**W**  
**AR**

**Serving stand 3-tier**  
Alzata 3 piani  
Servierstand 3-stufig  
Support 3 niveaux  
Soporte 3 pisos

art. dim. cm.  
41207-03 25x4,5x54

**Beech. Slate cm. 21x8 - 31x13 - 41x18.**  
Faggio. Ardesia cm. 21x8 - 31x13 - 41x18.



**W**

**Stand**  
Alzata  
Ständer  
Support  
Soporte

art. dim. cm.  
42463A00 20x20x17,5

**Acacia wood.**



**W**

**Stand**  
Alzata  
Ständer  
Support  
Soporte

art. dim. cm.  
42463B00 20x20x17,5

**Acacia wood.**





W

**Stand**

Alzata  
Ständer  
Support  
Soporte

art.	Ø cm.	h. cm.
41445-01	15	10
41445-02	35	15

Acacia wood. – Fig. bowls/ciotole 41445.



W

**Cereal-bar**

Espositore cereali  
Cerealien-Buffer-Ständer  
Présentoir à céréales  
Expositor de cereale

art.	dim. cm.	col.
42470-43	43x17x13,5	●

3 glasses lt. 2 with airtight cover.  
3 vasi lt. 2 con coperchio ermetico.



W

**Cereal-bar**

Espositore cereali  
Cerealienständer  
Présentoir à céréales  
Expositor de cereales

art.	dim. cm.	col.
42460-43	43x17x13,5	●

3 glasses lt. 2 with airtight cover.  
3 vasi lt. 2 con coperchio ermetico.



**Jam bar**

Espositore marmellate  
Konfitürenständer  
Présentoir à confitures  
Expositor de mermeladas

art.	dim. cm.	ml.
41206-05	34,5x9x8,5	3x176



AY

**Cereal-bar**

Espositore per cereali  
Cerealien-Bar  
Présentoir à céréales  
Expositor de cereales

art.	dim. cm.	lt.
41806-03	39,5x12x26	3x1



AY

**Cereal pitcher**

Caraffa cereali  
Cerealienkaraffe  
Pichet à céréales  
Jarra de cereales

art.	Ø cm.	dim. cm.	lt.
41806-00	9	25,5	1



SAN

SS

**Cereal dispenser**

Distributore di cereali  
Müslispender  
Distributeur à céréales  
Dispensador de cereales

art.	dim. cm.	lt.
41810-04	22x17,5x52	4,5





**SAN**  
**SS**

**Cereal dispenser**

Distributore di cereali  
Müslispender  
Distributeur à céréales  
Dispensador de cereales

art. dim. cm. lt.  
41810-09 22x35x52 2x4,5



**PC**  
**SS**

**Cereal dispenser**

Distributore di cereali  
Müslispender  
Distributeur à céréales  
Dispensador de cereales

art. dim. cm. lt.  
41909-08 33x24x64 7



**PC**  
**SS**

**Cereal dispenser**

Distributore di cereali  
Müslispender  
Distributeur à céréales  
Dispensador de cereales

art. dim. cm. lt.  
41807-12 30,5x28,5x60,5 3x4



**SS**

**Juice dispenser**

Distributore di succhi  
Saftdispenser  
Distributeur à jus  
Dispensador de zumos

art. dim. cm. lt.  
41901-08 36x26x55 8



**SS**

**Juice dispenser duo**

Distributore di succhi duo  
Saftdispenser duo  
Distributeur à jus duo  
Dispensador de zumo, doble

art. dim. cm. lt.  
41901-16 36x54x55 2x8



**SS**

**Juice dispenser**

Distributore di succhi  
Saftdispenser  
Distributeur à jus  
Dispensador de zumos

art. dim. cm. lt.  
18353-17 22x35x56 7

With 1 cooling unit. – Con 1 eutettico.



**SS**

**Juice dispenser**

Distributore di succhi  
Saftdispenser  
Distributeur à jus  
Dispensador de zumos

art. dim. cm. lt.  
41800-05 33x22x52 5



**SS**

**Juice dispenser duo**

Distributore di succhi duo  
Saftdispenser duo  
Distributeur à jus duo  
Dispensador de zumo, doble

art. dim. cm. lt.  
41800-10 42,5x30,5x52 2x5



**SS**

**Milk dispenser**

Distributore di latte  
Milchkanne  
Distributeur à lait  
Dispensador de leche

art. dim. cm. lt.  
41801-05 33x22x50 5



W

**Cereal dispenser**

Distributore di cereali  
Cerealinenspender  
Distributeur à céréales  
Dispensador de cereales

art.	dim. cm.	lt.	col.
42470-45	21x20x55,5	4,5	●
42460-45	21x20x55,5	4,5	●

Maple/Wenge. – Acero/Wengè.



W

**Juice dispenser**

Distributore di succhi  
Saftdispenser  
Distributeur à jus de fruit  
Dispensador de zumo

art.	dim. cm.	lt.
41808-04	16x24x35	4



W

**Juice dispenser**

Distributore di succhi  
Saftdispenser  
Distributeur à jus de fruit  
Dispensador de zumo

art.	dim. cm.	lt.	col.
42470-74	31x20x42	4	●
42470-76	35,5x22x50	6	●

Maple. With 2 cooling units. elements, top and base. – Acero. Con 2 eutettici, coperchio e base.



W

**Juice dispenser**

Distributore di succhi  
Saftdispenser  
Distributeur à jus de fruit  
Dispensador de zumo

art.	dim. cm.	lt.	col.
42460-74	31x20x42	4	●
42460-76	35,5x22x50	6	●

Wenge. With 2 cooling units. elements, top and base. – Wengè. Con 2 eutettici, coperchio e base.



W

SS

**Juice dispenser**

Distributore di succhi  
Saftdispenser  
Distributeur à jus  
Dispensador de zumos

art.	dim. cm.	lt.
41907-04	21x31x44	4
41907-06	23x35x52	6

Beechwood. With cooling units.  
Faggio. Con eutettici.



W

PR

SS

**Milk dispenser**

Distributore di latte  
Milchkanne  
Distributeur à lait  
Dispensador de leche

art.	dim. cm.	lt.
41900-04	23x32x42	4
41900-10	27x38,5x45	10

Beechwood. With cooling units.  
Faggio. Con eutettici.



SS

PP

**Insulated dispenser**

Distributore termico  
Iso-Dispenser  
Distributeur isothermique  
Dispensador térmico

art.	Ø cm.	h. cm.	lt.
41904-10	24	42>46,5	9,5



SS

**Air pot**

Caraffa termica  
Thermopumpkanne  
Pot à air isothermique  
Jarra térmica

art.	lt.
42406-35	3,5
42406-40	4,0



SS

**Air pot**

Caraffa termica  
Thermopumpkanne  
Pot à air isothermique  
Jarra térmica

art.	lt.
42400-19	1,9
42400-25	2,5
42400-30	3,0





# SERIES 12300

BUFFET LIVE COOKING



Paderno serie 2300 3-ply is especially designed for use in front of house and live cooking stations. Features super heat-conductive multi-layer construction that distributes heat from bottom to rim quickly and evenly. An attractive, multifunctional and colored line available in white, yellow, green, blue and orange. External finish with special heat-resistant paint (Whitford technology). Ideal for all types of cooking including induction. The lid equipped with a steam release device can be hooked to the side of the pan.

La serie Paderno 2300 3-ply è concepita per l'uso "front of house" e per le "live cooking stations". Costruita in materiale multistrato, assicura una distribuzione rapida ed uniforme del calore su tutta la superficie dell'utensile. Una linea attrattiva, multifunzionale e colorata disponibile nelle varianti bianco, giallo, verde, blu e arancio. Finitura esterna con speciale vernice (tecnologia Whitford) resistente al calore. Ideali per ogni tipo di cottura inclusa l'induzione. Il coperchio dotato di dispositivo di rilascio del vapore, può essere agganciato a lato della casseruola





**Stew pan with lid**

Casseruola con coperchio  
Brattpf mit Deckel  
Sautoir avec couvercle  
Sartén con tapa

art.	Ø cm.	h. cm.	lt.
12303W16	16	8	1,6
12303W20	20	10	3,1
12303W24	24	12	5,4



**Stew pan with lid**

Casseruola con coperchio  
Brattpf mit Deckel  
Sautoir avec couvercle  
Sartén con tapa

art.	Ø cm.	h. cm.	lt.
12303Y16	16	8	1,6
12303Y20	20	10	3,1
12303Y24	24	12	5,4



**Stew pan with lid**

Casseruola con coperchio  
Brattpf mit Deckel  
Sautoir avec couvercle  
Sartén con tapa

art.	Ø cm.	h. cm.	lt.
12303G16	16	8	1,6
12303G20	20	10	3,1
12303G24	24	12	5,4



**Stew pan with lid**

Casseruola con coperchio  
Brattpf mit Deckel  
Sautoir avec couvercle  
Sartén con tapa

art.	Ø cm.	h. cm.	lt.
12303B16	16	8	1,6
12303B20	20	10	3,1
12303B24	24	12	5,4



**Stew pan with lid**

Casseruola con coperchio  
Brattpf mit Deckel  
Sautoir avec couvercle  
Sartén con tapa

art.	Ø cm.	h. cm.	lt.
12303O16	16	8	1,6
12303O20	20	10	3,1
12303O24	24	12	5,4



**Roasting pan with lid**

Casseruola carrè con coperchio  
Bräter mit Deckel  
Rôtissoire avec couvercle  
Asadera con tapa

art.	dim. cm.	h. cm.	lt.
12304W26	27x27	7	4



**Roasting pan with lid**

Casseruola carrè con coperchio  
Bräter mit Deckel  
Rôtissoire avec couvercle  
Asadera con tapa

art.	dim. cm.	h. cm.	lt.
12304Y26	27x27	7	4



**Roasting pan with lid**

Casseruola carrè con coperchio  
Bräter mit Deckel  
Rôtissoire avec couvercle  
Asadera con tapa

art.	dim. cm.	h. cm.	lt.
12304G26	27x27	7	4



**Roasting pan with lid**

Casseruola carrè con coperchio  
Bräter mit Deckel  
Rôtissoire avec couvercle  
Asadera con tapa

art.	dim. cm.	h. cm.	lt.
12304B26	27x27	7	4



**Roasting pan with lid**

Casseruola carrè con coperchio  
Bräter mit Deckel  
Rôtissoire avec couvercle  
Asadera con tapa

art.	dim. cm.	h. cm.	lt.
12304O26	27x27	7	4





**NEW**

**Induction station**  
Set induzione  
Induktionsstation  
Station d'induction  
Estación inducción

art.	Ø cm.	dim. cm.	h. cm.	V	W
49999-04	24	35,4x32,5	19	220-240	900

**Induction plate with temperature regulator 60>140°C. Black metal support, walnut wood insert and stainless steel frame.** – Piastra a induzione con regolatore di temperatura 60>140°C. Supporto in metallo nero, inserto in legno di noce e cornice inox.



**Bowl double wall**  
Ciotola doppia parete  
Schüssel, doppelwandig  
Bol à double paroi  
Tazón doble pared

art.	Ø cm.	h. cm.
12300-18	18	14,0
12300-24	24	18,2



**Bowl double wall**  
Ciotola doppia parete  
Schüssel, doppelwandig  
Bol à double paroi  
Tazón doble pared

art.	Ø cm.	h. cm.
12300W18	18	14,0
12300W24	24	18,2



**Bowl double wall**  
Ciotola doppia parete  
Schüssel, doppelwandig  
Bol à double paroi  
Tazón doble pared

art.	Ø cm.	h. cm.
12300Y18	18	14,0
12300Y24	24	18,2



**Bowl double wall**  
Ciotola doppia parete  
Schüssel, doppelwandig  
Bol à double paroi  
Tazón doble pared

art.	Ø cm.	h. cm.
12300G18	18	14,0
12300G24	24	18,2



**Bowl double wall**  
Ciotola doppia parete  
Schüssel, doppelwandig  
Bol à double paroi  
Tazón doble pared

art.	Ø cm.	h. cm.
12300B18	18	14,0
12300B24	24	18,2



**Bowl double wall**  
Ciotola doppia parete  
Schüssel, doppelwandig  
Bol à double paroi  
Tazón doble pared

art.	Ø cm.	h. cm.
12300O18	18	14,0
12300O24	24	18,2





# ATLANTIC BUFFET SYSTEM

BUFFET & PRESENTATION



Conceived and designed in the round and rectangular versions with different opening systems to meet any need ABS Atlantic Buffet System chafing dishes combine contemporary flexibility and functionality. All the parts of these simple-shaped, stackable, 100% stainless steel hygienic items can be easily taken apart for thorough cleaning.

The line comes from the expertise that only Sambonet Paderno can offer to top catering services. The lid is equipped with a new, transparent window made of unbreakable glass that lets you see the delicacies held in the chafing dishes. The gradual closing mechanism and the special lid removal method make the whole System even more effective.

Pensati e ideati nelle versioni rotonde, rettangolari con aperture differenziate per soddisfare ogni esigenza, gli scaldavivande ABS Atlantic Buffet System interpretano la funzionalità e la flessibilità contemporanea. Semplici nella forma, impilabili, igienici poiché realizzati in acciaio inox, facilmente smontabili in tutte le loro parti per una pulizia impeccabile, gli elementi appartenenti alla linea nascono dall'expertise che solo Sambonet Paderno è in grado di garantire alla ristorazione d'eccellenza. Grazie alla trasparenza del nuovo oblò in vetro temperato, i coperchi offrono visibilità alla prelibatezza dei contenuti degli scaldavivande. Il meccanismo di chiusura graduale e lo speciale metodo di rimozione dei coperchi rende ancora più performante l'intero Sistema.



## ATLANTIC TOP UNITS - DA APPOGGIO



### TOP UNIT - Chafing dish round

Scaldavivande tondo  
Chafing Dish, rund  
Chafing dish rond  
Chafing dish redondo

art.	Ø cm.	h. cm.	lt.
18176-30	30	15	2,8
18176-36	36	15	5,0
18176-40	40	17	7,8



### TOP UNIT - Chafing dish round

Scaldavivande tondo  
Chafing Dish, rund  
Chafing dish rond  
Chafing dish redondo

art.	Ø cm.	h. cm.	lt.
18176I30	30	15	2,8
18176I36	36	15	5,0
18176I40	40	17	7,8



### TOP UNIT - Chafing dish round

Scaldavivande tondo  
Chafing Dish, rund  
Chafing dish rond  
Chafing dish redondo

art.	Ø cm.	h. cm.	lt.
18166-24	24	15	2,0
18166-30	30	15	2,8
18166-36	36	15	5,0
18166-40	40	17	7,8



### TOP UNIT - Chafing dish round

Scaldavivande tondo  
Chafing Dish, rund  
Chafing dish rond  
Chafing dish redondo

art.	Ø cm.	h. cm.	lt.
18166I30	30	15	2,8
18166I36	36	15	5,0
18166I40	40	17	7,8



### TOP UNIT - Chafing dish rectangular

Scaldavivande rettangolare  
Chafing Dish, rechteckig  
Chafing dish rectangulaire  
Chafing dish rectangular

art.	dim. cm.	lt.
18172-54	57x47x18	10

**Long side opening.** – Apertura lato lungo.



### TOP UNIT - Chafing dish rectangular

Scaldavivande rettangolare  
Chafing Dish, rechteckig  
Chafing dish rectangulaire  
Chafing dish rectangular

art.	dim. cm.	lt.
18172-56	68,5x35,5x18	10

**Short side opening.** – Apertura lato corto.



**TOP UNIT - Chafing dish rectangular**

Scaldavivande rettangolare  
 Chafing Dish, rechteckig  
 Chafing dish rectangulaire  
 Chafing dish rectangular

art.	dim. cm.	lt.
18162-54	57x47x18	10

**Long side opening.** – Apertura lato lungo.**TOP UNIT - Chafing dish rectangular**

Scaldavivande rettangolare  
 Chafing Dish, rechteckig  
 Chafing dish rectangulaire  
 Chafing dish rectangular

art.	dim. cm.	lt.
18162-56	68,5x35,5x18	10

**Short side opening.** – Apertura lato corto.**ATLANTIC BUILT-IN UNITS - DA INCASSO****BUILT-IN UNIT - Chafing dish rectangular**

Scaldavivande rettangolare  
 Chafing Dish, rechteckig  
 Chafing dish rectangulaire  
 Chafing dish rectangular

art.	dim. cm.	lt.	std	V-W
18162A55	57x47x18	10		
18162E55	57x47x18	10	EU	250-360
18162U55	57x47x18	10	US	120-450

**Long side opening.** – Apertura lato lungo.

art.	dim. cm.	lt.	std	V-W
18162A57	68,5x35,5x18	10		
18162E57	68,5x35,5x18	10	EU	250-360
18162U57	68,5x35,5x18	10	US	120-450

**Short side opening.** – Apertura lato corto.

art.	dim. cm.	lt.	std	V-W
18172A55	57x47x18	10		
18172E55	57x47x18	10	EU	250-360
18172U55	57x47x18	10	US	120-450

**Long side opening.** – Apertura lato lungo.

art.	dim. cm.	lt.	std	V-W
18172A57	68,5x35,5x18	10		
18172E57	68,5x35,5x18	10	EU	250-360
18172U57	68,5x35,5x18	10	US	120-450

**Short side opening.** – Apertura lato corto.

## ATLANTIC ON STAND UNITS - CON SUPPORTO



**Chafing dish, solid alcohol heating**  
Scaldavivande a combustibile solido  
Chafing Dish mit Brennstoff beheizt  
Chafing dish chauffage combustible solide  
Chafing dish calefacción combustible sólido

art.	Ø cm.	h. cm.	lt.
18176A30	30	27	2,8
18176A36	36	27	5,0
18176A40	40	28	7,8



**Chafing dish, solid alcohol heating**  
Scaldavivande a combustibile solido  
Chafing Dish mit Brennstoff beheizt  
Chafing dish chauffage combustible solide  
Chafing dish calefacción combustible sólido

art.	Ø cm.	h. cm.	lt.
18166A24	24	27	2,0
18166A30	30	27	2,8
18166A36	36	27	5,0
18166A40	40	28	7,8



**Chafing dish, electric heating**  
Scaldavivande, riscaldamento elettrico  
Chafing Dish, elektrisch beheizt  
Chafing dish chauffage électrique  
Chafing dish calefacción eléctrica

art.	Ø cm.	h. cm.	lt.	std	V-W
18176E30	30	27	2,8	EU	250-190
18176E36	36	27	5,0	EU	250-190
18176E40	40	28	7,8	EU	250-190
18176U36	36	27	5,0	US	120-240
18176U40	40	28	7,8	US	120-240



**Chafing dish, electric heating**  
Scaldavivande, riscaldamento elettrico  
Chafing Dish, elektrisch beheizt  
Chafing dish chauffage électrique  
Chafing dish calefacción eléctrica

art.	Ø cm.	h. cm.	lt.	std	V-W
18166E24	24	27	2,0	EU	250-80
18166E30	30	27	2,8	EU	250-190
18166E36	36	27	5,0	EU	250-190
18166E40	40	28	7,8	EU	250-190
18166U24	24	27	2,0	US	120-170
18166U36	36	27	5,0	US	120-240
18166U40	40	28	7,8	US	120-240



**Petite marmite**  
Petite marmite  
Petite marmite  
Petite marmite  
Petite marmite

art.	Ø cm.	h. cm.	lt.	std	V-W
18168A24	24	35	7	-	-
18168E24	24	35	7	EU	250-80
18168U24	24	35	7	US	120-170



**Chafing dish rectangular**

Scaldavivande rettangolare

Chafing Dish, rechteckig

Chafing dish rectangulaire

Chafing dish rectangular

art.	dim. cm.	lt.	std	V-W
18172A54	57x47x30,5	10	-	-
18172E54	57x47x30,5	10	EU	250-360
18172U54	57x47x30,5	10	US	120-450

**Long side opening.** – Apertura lato lungo.



**Chafing dish rectangular**

Scaldavivande rettangolare

Chafing Dish, rechteckig

Chafing dish rectangulaire

Chafing dish rectangular

art.	dim. cm.	lt.	std	V-W
18172A56	68,5x35,5x30,5	10	-	-
18172E56	68,5x35,5x30,5	10	EU	250-360
18172U56	68,5x35,5x30,5	10	US	120-450

**Short side opening.** – Apertura lato corto.



**Chafing dish rectangular**

Scaldavivande rettangolare

Chafing Dish, rechteckig

Chafing dish rectangulaire

Chafing dish rectangular

art.	dim. cm.	lt.	std	V-W
18162A54	57x47x30,5	10	-	-
18162E54	57x47x30,5	10	EU	250-360
18162U54	57x47x30,5	10	US	120-450

**Long side opening.** – Apertura lato lungo.



**Chafing dish rectangular**

Scaldavivande rettangolare

Chafing Dish, rechteckig

Chafing dish rectangulaire

Chafing dish rectangular

art.	dim. cm.	lt.	std	V-W
18162A56	68,5x35,5x30,5	10	-	-
18162E56	68,5x35,5x30,5	10	EU	250-360
18162U56	68,5x35,5x30,5	10	US	120-450

**Short side opening.** – Apertura lato corto.



**ASIA LINE**



**Chafing dish rectangular**

Scaldavivande rettangolare  
Chafing Dish, rechteckig  
Chafing dish rectangulaire  
Chafing dish rectangular



art.	dim. cm.	lt.	std	V-W
18132A54	67,5x44x42	10	-	-
18132E54	67,5x44x42	10	EU	250-360
18132U54	67,5x44x42	10	US	120-450

**Chafing dish, to be built in**

Scaldavivande da incasso  
Einbau Chafing Dish  
Chafing dish encastrable  
Chafing dish encastrable



art.	dim. cm.	lt.	std	V-W
18132A55	67,5x44x34,5	10	-	-
18132E55	67,5x44x34,5	10	EU	250-360
18132U55	67,5x44x34,5	10	US	120-450

**Chafing dish round**

Scaldavivande tondo  
Chafing Dish, rund  
Chafing dish rond  
Chafing dish redondo



art.	Ø cm.	h. cm.	lt.	std	V-W
18136A33	33	44	3,5	-	-
18136E33	33	44	3,5	EU	250-200
18136U33	33	44	3,5	US	120-240
18136A40	40	58	6,0	-	-
18136E40	40	58	6,0	EU	250-360
18136U40	40	58	6,0	US	120-450



**Chafing dish round, to be built in**

Scaldavivande tondo da incasso

Chafing Dish, rund

Chafing dish rond encastrable

Chafing dish redondo encastrable

art.	Ø cm.	h. cm.	lt.	std	V-W
18136A34	33	34,5	3,5	-	-
18136E34	33	34,5	3,5	EU	250-200
18136U34	33	34,5	3,5	US	120-240
18136A41	40	43,0	6,0	-	-
18136E41	40	43,0	6,0	EU	250-360
18136U41	40	43,0	6,0	US	120-450

**Chafing dish rectangular**

Scaldavivande rettangolare

Chafing Dish, rechteckig

Chafing dish rectangulaire

Chafing dish rectangular

art.	dim. cm.	lt.	std	V-W
18152A54	67x49x44	10	-	-
18152E54	67x49x44	10	EU	250-360
18152U54	67x49x44	10	US	120-450

**Chafing dish round**

Scaldavivande tondo

Chafing Dish, rund

Chafing dish rond

Chafing dish redondo

art.	Ø cm.	h. cm.	lt.	std	V-W
18156A33	33	47	3,5	-	-
18156E33	33	47	3,5	EU	250-200
18156U33	33	47	3,5	US	120-240
18156A40	40	61	6,0	-	-
18156E40	40	61	6,0	EU	250-360
18156U40	40	61	6,0	US	120-450

**Chafing dish rectangular**

Scaldavivande rettangolare

Chafing Dish, rechteckig

Chafing dish rectangulaire

Chafing dish rectangular

art.	dim. cm.	lt.	std	V-W
41690A11	63,5x35x32	8,5	-	-
41690E11	63,5x35x32	8,5	EU	250-360
41690U11	63,5x35x32	8,5	US	120-450

**Chafing dish rectangular**

Scaldavivande rettangolare

Chafing Dish, rechteckig

Chafing dish rectangulaire

Chafing dish rectangular

art.	dim. cm.	lt.	std	V-W
41691A11	71,5x52x45	8,5	-	-
41691E11	71,5x52x45	8,5	EU	250-360
41691U11	71,5x52x45	8,5	US	120-450





**Coffee urn**  
Scaldacaffè  
Kaffeedispenser  
Réchaud à café  
Calentador de café

art.	dim. cm.	lt.	std	V-W
41903A10	31x33,5x54,5	10,5	-	-
41903E10	31x33,5x54,5	10,5	EU	220-80
41903U10	31x33,5x54,5	10,5	US	110-170



**Samovar**  
Pyramid

art.	dim. cm.	lt.	Tea pot	std	V-W
49856-04	35,5x30x45,2	4	Lt 1,2	EU	2500

**Teapot with strainer. Cable length approx. 130 cm. With 2 heating elements 2000W and 500W.**  
Teiera con colino. Lunghezza cavo circa 130 cm. Con 2 resistenze 2000W e 500W.



**Samovar**  
2017

art.	dim. cm.	lt.	Tea pot	std	V-W
49854-03	31x27,5x48,5	3	Lt 1,2	EU	1500

**Teapot with strainer, cable length approx. 130 cm. –** Teiera con colino. Lunghezza cavo circa 130 cm.



**Samovar**  
Romanov

art.	dim. cm.	lt.	Tea pot	std	V-W
49855-05	34x27x59	5	Lt 1,3	EU	1800

**Teapot with strainer. Cable length approx. 100 cm. With 2 heating elements 1300W and 500W.**  
Teiera con colino. Lunghezza cavo circa 100 cm. Con 2 resistenze 1300W e 500W.



**Samovar**  
3006C

art.	dim. cm.	lt.	Tea pot	std	V-W
49854-06	35,5x30x45,2	6	Lt 1,5	EU	2500

**Teapot with strainer. With 2 heating elements 2000W and 500W. – Teiera con colino. Con 2 resistenze 2000W e 500W.**



**Samovar**  
Soraya

art.	dim. cm.	lt.	Tea pot	std	V-W
49855-10	35,2x44,5x69	10	Lt 1,6	EU	3000

**Teapot with strainer. Cable length approx. 130 cm. With 2 heating elements 2300W and 700W.**  
Teiera con colino. Lunghezza cavo circa 130 cm. Con 2 resistenze 2300W e 700W.



**Samovar**  
Katharina

art.	dim. cm.	lt.	Tea pot	std	V-W
49855-15	39,5x44,5x74,5	15	Lt 2,0	EU	3000

**Teapot with strainer. Cable length approx. 130 cm. With 2 heating elements 2300W and 700W.**  
Teiera con colino. Lunghezza cavo circa 130 cm. Con 2 resistenze 2300W e 700W.



**Coffee percolator**  
Percolatore per caffè  
Kaffee-Perkolator  
Percolateur à café  
Percolator de café

art.	Ø cm.	h. cm.	lt.	std	V-W
49846-05	28	38,5	4,5	EU	950
49846-09	28	38,5	9,2	EU	950
49846-15	33	54	15	EU	1650





**Soup kettle**  
Zuppiera  
Suppenwärmer  
Marmite à soupe  
Olla de sopa

art.	Ø cm.	h. cm.	lt.	std	V-W
49847-38	38	36,5	10	EU	230-450/550



**Soup kettle**  
Zuppiera  
Suppenwärmer  
Marmite à soupe  
Olla de sopa

art.	Ø cm.	h. cm.	lt.	std	V-W
49847-08	33	37	10	EU	230-400



**Soup kettle**  
Zuppiera  
Suppenkessel  
Marmite à soupe  
Olla de sopa



art.	Ø cm.	h. cm.	lt.
49790-09	48	32	10







**Induction cooker, to be built into counter**

Piastra ad induzione, da incasso  
Induktionsplatte, thekeneinbau  
Plaque à induction, montage en comptoir  
Placa a inducción para emportar

art.	std	dim. cm.
18162-RB	EU	36X38x12,5

**Schott ceran hob, timer (0-180 min.), 1-10 power levels, temperature range 60°C-240°C.**

Piano in vetroceramica Schott, timer 0-180 minuti, 1-10 livelli di potenza, temperatura 60-240°C.



**Induction cooker**

Piastra ad induzione  
Induktionsplatte  
Plaque à induction  
Placa a inducción

art.	std	dim. cm.
18162-RA	EU	30X37x10

**Stainless steel body, Schott ceran hob, led display, timer (0-180 min.), 1-10 power levels, temperature range 60°C-240°C.**

Corpo inox, piano in vetroceramica Schott, display a led, timer 0-180 minuti, 1-10 livelli di potenza, temperatura 60-240°C.



NEW

**Induction station**

Postazione induzione  
Induktionsstation  
Station d'induction  
Estación inducción

art.	std	dim. cm.
49999-04	EU	35,4x32,5x19 900

**Induction plate with temperature regulator 60>140°C. Black metal support, walnut wood insert and stainless steel frame.**

Piastra a induzione con regolatore di temperatura 60>140°C. Supporto in metallo nero, inserto in legno di noce e cornice inox.



**Round stand**

Supporto rotondo  
Gestell, rund  
Support rond  
Soporte redondo

art.	Ø cm.
18166-AA	24
18166-AM	30
18166-AB	36
18166-AC	40



**Rectangular stand**

Supporto rettangolare  
Gestell, rechteckig  
Support rectangulaire  
Soporte rectangular

art.	dim. cm.
18162-AA	57x47



**Soup tureen without lid**

Zuppiera senza coperchio  
Suppenschüssel ohne Deckel  
Soupière sans couvercle  
Sopera sin tapa

art.	Ø cm.	lt.
18168-GA	24	7



**Round food pan, stainless steel**  
Portavivande tondo, inox  
Einsatzbehälter, rund, Edelstahl Rostfrei  
Bac rond, inox  
Baño-maria redondo, inox

art.	Ø cm.	h. cm.	lt.
18136-EA	33	6,0	3,5
18136-EB	40	7,5	6,0

**For ASIA round chafing dishes.**  
Per scaldavivande ASIA tondi.



**Round food pan, stainless steel**  
Portavivande tondo, inox  
Einsatzbehälter, rund, Edelstahl Rostfrei  
Bac rond, inox  
Baño-maria redondo, inox

art.	Ø cm.
18166-EG	24
18166-EM	30
18166-EH	36
18166-EI	40

**For ABS round chafing dishes.**  
Per scaldavivande ABS tondi.



**Round porcelain insert**  
Inserto tondo, porcellana  
Porzellaneinsatz, rund  
Bac rond, porcelaine  
Baño-maria redondo, porcelana

art.	Ø cm.	h. cm.
44352-30	33	5,7
44352-40	40	7,5

**For ASIA round chafing dishes.**  
Per scaldavivande ASIA tondi.



**Round porcelain insert, 2 food sections**  
Inserto tondo, porcellana, 2 scomparti  
Porzellaneinsatz 2-tlg., rund  
Bac rond, porcelaine, 2 compartements  
Baño-maria redondo, porcelana 2 compartimentos

art.	Ø cm.	h. cm.
44355-30	33	5,7
44355-40	40	7,5

**For ASIA round chafing dishes.**  
Per scaldavivande ASIA tondi.



**Round porcelain insert**  
Inserto tondo, porcellana  
Porzellaneinsatz, rund  
Bac rond, porcelaine  
Baño-maria redondo, porcelana

art.	Ø cm.
18166-EL	30
18166-EC	36
18166-EB	40

**For ABS round chafing dishes.**  
Per scaldavivande ABS tondi.



**Round porcelain insert, 2 food sections**  
Inserto tondo, porcellana, 2 scomparti  
Porzellaneinsatz 2-tlg., rund  
Bac rond, porcelaine, 2 compartements  
Baño-maria redondo, porcelana 2 compartimentos

art.	Ø cm.
18166-ED	36
18166-EJ	40

**For ABS round chafing dishes.**  
Per scaldavivande ABS tondi.



**Food pan GN 1/1, stainless steel**  
Bacinella GN 1/1, inox  
GN-Behälter 1/1, Edelstahl Rostfrei  
Bac GN 1/1, inox  
Baño-maria GN 1/1, inox

art.	dim. cm.
14102-04	53x32,5x4
14102-06	53x32,5x6,5



**Food pan GN 1/1, porcelain**  
Bacinella GN 1/1, porcellana  
GN-Behälter 1/1, Porzellan  
Bac GN 1/1, porcelaine  
Baño-maria GN 1/1, porcelana

art.	dim. cm.
44332-03	53x32,5x2
44332-06	53x32,5x6,5



**Fuel Holder, stainless steel**  
Portacombustibile, inox  
Brennstoffhalterung, Edelstahl Rostfrei  
Porte Brûleur, inox  
Contenedor de combustible, inox

art.	Ø cm.	h. cm.
41809-09	9	6,5

**Suitable for chafing dishes items 41690 and 41691.** – Adatto per gli scaldavivande art. 41690 e 41691.



**Fuel Holder, stainless steel**  
Portacombustibile, inox  
Brennstoffhalterung, Edelstahl Rostfrei  
Porte Brûleur, inox  
Contenedor de combustible, inox

art.	Ø cm.	h. cm.
18132-FB	10	7,5

**Suitable for chafing dishes items 18152 and 18156.** – Adatto per gli scaldavivande art. 18152 e 18156.



**Fuel Holder, stainless steel**  
Portacombustibile, inox  
Brennstoffhalterung, Edelstahl Rostfrei  
Porte Brûleur, inox  
Contenedor de combustible, inox

18136-KA
----------

**Kit for ABS round ø cm 24-30-36.**  
Set per scaldavivande ABS ø cm 24-30-36.



**Fuel Holder, stainless steel**  
Portacombustibile, inox  
Brennstoffhalterung, Edelstahl Rostfrei  
Porte Brûleur, inox  
Contenedor de combustible, inox

18132-KA
----------

**Kit for ABS rectangular and round ø cm 40.**  
Set per scaldavivande ABS rettangolari e ø cm 40.



**Jelly fuel**

Gel combustibile  
Brenngel  
Gel combustible  
Combustible gel

art.	lt.	gr.	U. Pack
41695-15	-	200	2
41695-10	1	-	-
41695-50	5	-	-
41695-90	10	-	-



**Thermoregulator**  
Termoregolatore  
Thermoregler  
Thermorégulateur  
Termorregulador

art.	std
18132-AE	EU

**For rectangular and round units ø cm 30-33-36-40.** – Per scaldavivande rettangolari e tondi ø cm 30-33-36-40.



**Thermoregulator**  
Termoregolatore  
Thermoregler  
Thermorégulateur  
Termorregulador

art.	std
18132-AU	US

**For rectangular and round units ø cm 30-33-36-40.** – Per scaldavivande rettangolari e tondi ø cm 30-33-36-40.



**Electric heating units**

Piastre elettriche  
Elektro-Heizelemente  
Corps de chauffe électriques  
Calentadores eléctricos

art.	std	V-W
18136-KE	EU	220-200
18136-KU	US	110-240

**Cm. 20x20 - For ASIA round chafing dishes cm 33.** – Per scaldavivande ASIA tondo cm 33.



**Electric heating units**

Piastre elettriche  
Elektro-Heizelemente  
Corps de chauffe électriques  
Calentadores eléctricos

art.	std	V-W
18166-KP	EU	220-180

**Cm. 20x21 - For ABS round ø cm 30.**  
Per scaldavivande ABS tondo ø cm 30.



**Electric heating units**

Piastre elettriche  
Elektro-Heizelemente  
Corps de chauffe électriques  
Calentadores eléctricos

art.	std	V-W
18166-KE	EU	220-200
18166-KU	US	110-240

**Cm. 20x25 - For ABS round ø cm 36-40.**  
Per scaldavivande ABS tondo ø cm 36-40.



**Electric heating units**

Piastre elettriche  
Elektro-Heizelemente  
Corps de chauffe électriques  
Calentadores eléctricos

art.	std	V-W
18132-KE	EU	220-380
18132-KU	US	110-450

**Cm. 20x25 - For ASIA rectangular and round chafing dishes cm 40.** – Per scaldavivande ASIA rettangolari e tondi cm 40.



**Electric heating units**

Piastre elettriche  
Elektro-Heizelemente  
Corps de chauffe électriques  
Calentadores eléctricos

art.	std	V-W
18162-KE	EU	220-380
18162-KU	US	110-450

**Cm. 20x25 - For ABS rectangular.**  
Per scaldavivande ABS rettangolari.



**Electric heating units**

Piastre elettriche  
Elektro-Heizelemente  
Corps de chauffe électriques  
Calentadores eléctricos

art.	std	V-W
18341-KE	EU	220-80
18341-KU	US	110-170

**Cm. Ø 13,5 - For ABS round ø cm 24.**  
Per scaldavivande ABS tondo ø cm 24.





# SERIES VERSAILLES

DINING ROOM TROLLEYS  
CARRELLI SALA



Main structure and tops in plywood with reinforced edges. Legs in beechwood. Standard finishing rosewood color. Other colors: walnut, mahogany and oak. Standard swivel casters in antistatic rubber, on request polyurethane casters. All trolleys are available equipped with rubber bumper.

Struttura portante, piani di servizio in legno multistrato con bordi massicci. Gambe in massello di faggio. Finitura standard tinta palissandro. Su richiesta colori: noce, mogano e rovere. Ruote standard in gomma antistatica, optional ruote in poliuretano. Tutti i carrelli possono essere dotati di profilo paraurti.





#### Roast beef/stew trolley

Carrello arrostiti/bolliti  
Rinderbrust-/Fleischgerichtewagen  
Chariot à rôtis  
Carro roast beef

art.	dim. cm.	Kg.	V	W	color	col.
18874-11	126x62x109	54	120	600	rosewood	●
18874M11	126x62x109	54	120	600	mahogany	●
18874N11	126x62x109	54	120	600	walnut	●
18874R11	126x62x109	54	120	600	oak	●
18874-22	126x62x109	54	230	700	rosewood	●
18874M22	126x62x109	54	230	700	mahogany	●
18874N22	126x62x109	54	230	700	walnut	●
18874R22	126x62x109	54	230	700	oak	●

**18-10 s/s revolving top adjustable up to 180°, mirror polish finishing - 4 swivel casters, 2 with brakes, bain-marie tank with 3 GN 1/2 10 litres each - removable wilsonart cutting board mm 354x265 revolving plate rack and removable knife holder in 18-10 s/s - 2 taps for water discharge - 2 heating units 700W each - 1 built in plug, backside - 3 built-in plugs, deck downside - 2 pipe plugs - cable - 3 switches, (1 magneto-thermic).** – Cloche inox 18-10 lucido a specchio, apertura a scomparsa a 180° - 4 ruote pivotanti, 2 con freno – vasca bagnomaria con 3 portavivande GN 1/2 da lt 10 cad. - tagliere mobile in wilsonart, mm 354x265 - portapiatti ribaltabile e portacoltelli estraibile in acciaio inox 18-10 - 2 rubinetti di scarico a sfera - 2 piastre elettriche da 700W cad. - 1 spina ad incasso (posteriore carrello) - 3 prese ad incasso (sotto piano carrello) - 2 spine a pipa - cavo di alimentazione - 3 interruttori di cui 1 magnetotermico.



#### Flambé trolley

Carrello flambé  
Flambierwagen  
Chariot à flamber  
Carro flambé

art.	dim. cm.	Kg.	color	col.
18876-00	122x58,5x89,5	44,5	rosewood	●
18876M00	122x58,5x89,5	44,5	mahogany	●
18876N00	122x58,5x89,5	44,5	walnut	●
18876R00	122x58,5x89,5	44,5	oak	●

**4 swivel casters, 2 with brakes - upper deck in 18-10 stainless steel mm 540x1042 with bottle holder protection ring - 2 lower wooden decks - cabinet for gas cylinder - gas/burning/lighting unit - piezoelectric lighting device - operating with liquid butan gas, 2,75 kg rechargeable cylinder (lasting for 20 hours about) or 1,8 kg cylinder - trolley supplied without cylinder.** – 4 ruote pivotanti di cui 2 con freno - pianale inox mm 540x1042 completo di barriera portabottiglie - 2 piani d'appoggio inferiori in legno - vano porta bombole con sportello di chiusura - gruppo gas/bruciatore/accenditore - dispositivo di accensione piezoelettrico - funzionamento a gas liquido butano in bombola ricaricabile da kg 2,75 (autonomia 20 ore circa) oppure da kg 1,8 - bombola NON fornita.



#### Standard gueridon trolley

Carrello gueridon, standard  
Gueridonwagen, Standard  
Chariot gueridon, standard  
Carro gueridon estándar

art.	dim. cm.	Kg.	color	col.
18886-00	77,5x51x74,5	14,5	rosewood	●
18886M00	77,5x51x74,5	14,5	mahogany	●
18886N00	77,5x51x74,5	14,5	walnut	●
18886R00	77,5x51x74,5	14,5	oak	●

**4 swivel casters without brakes. Upon request, the trolley can be supplied equipped with intermediate shelf.** – 4 ruote pivotanti, senza freno. Su richiesta è possibile fornire il carrello dotato di piano intermedio.



#### De luxe gueridon trolley

Carrello gueridon, de luxe  
Gueridonwagen, Luxus-Ausführung  
Chariot gueridon, de luxe  
Carro gueridon, de luxe

art.	dim. cm.	Kg.	color	col.
18887-00	77,5x51x74,5	16,5	rosewood	●
18887M00	77,5x51x74,5	16,5	mahogany	●
18887N00	77,5x51x74,5	16,5	walnut	●
18887R00	77,5x51x74,5	16,5	oak	●

**4 swivel casters without brakes - 6 compartments drawer – removable upper deck.** – 4 ruote pivotanti, senza freno - cassettiera a sei scomparti – piano d'appoggio estraibile.





**Flambé trolley, electric**

Carrello flambé, elettrico  
Flambierwagen, elektrisch  
Chariot à flamber, électrique  
Carro flambé, eléctrico

art.	dim. cm.	Kg.	V	W	color	col.
18876-01	122x58,5x89,5	44,5	230	2300	rosewood	●
18876M01	122x58,5x89,5	44,5	230	2300	mahogany	●
18876N01	122x58,5x89,5	44,5	230	2300	walnut	●
18876R01	122x58,5x89,5	44,5	230	2300	oak	●

**4 swivel casters, 2 with brakes – upper deck in 18-10 stainless steel mm 540x1042 with protection ring – 2 lower wooden decks - built-in electric heating unit, high-light, ø 32 cm, ceramic heating surface ø 26 cm - 1 built-in plug, backside - cable - adjustable heat control unit and 1 magnetotermic switch.** – 4 ruote pivotanti di cui 2 con freno - pianale inox mm 540x1042 completo di barriera perimetrale - 2 piani d'appoggio inferiori in legno - piastra elettrica high-light da incasso ø 32 cm, piano riscaldante in vetroceramica ø 26 cm - 1 spina ad incasso (posteriore carrello) - cavo di alimentazione - regolatore di energia ed interruttore magnetotermico.



**Flambé trolley, 2 burners**

Carrello flambé, 2 fuochi  
Flambierwagen, 2 Brenner  
Chariot à flamber, 2 feux  
Carro flambé, 2 fuegos

art.	dim. cm.	Kg.	color	col.
18877-00	122x58,5x89,5	46,5	rosewood	●
18877M00	122x58,5x89,5	46,5	mahogany	●
18877N00	122x58,5x89,5	46,5	walnut	●
18877R00	122x58,5x89,5	46,5	oak	●

**4 swivel casters, 2 with brakes - upper deck in 18-10 stainless steel mm 540x1042 with protection ring - 2 lower wooden decks - cabinet for gas cylinder – 2 gas/burning/lighting units - piezoelectric lighting device - operating with liquid butan gas, 2,75 kg rechargeable cylinder (lasting for 20 hours about) or 1,8 kg cylinder - trolley supplied without cylinder.** – 4 ruote pivotanti di cui 2 con freno - pianale inox mm 540x1042 completo di barriera perimetrale – 2 piani d'appoggio inferiori in legno - vano porta bombole con sportello di chiusura- 2 gruppi gas/bruciatore/accenditore - dispositivo di accensione piezoelettrico - funzionamento a gas liquido butano in bombola ricaricabile da kg 2,75 (autonomia 20 ore circa) oppure da kg 1,8 - bombola NON fornita.



**Mini flambé trolley**

Carrello mini-flambé  
Flambierwagen, Mini-Ausführung  
Chariot à flamber, mini  
Mini carro flambé

art.	dim. cm.	Kg.	color	col.
18875-00	77,5x51x74,5	22	rosewood	●
18875M00	77,5x51x74,5	22	mahogany	●
18875N00	77,5x51x74,5	22	walnut	●
18875R00	77,5x51x74,5	22	oak	●

**4 swivel casters without brakes - upper deck in 18-10 stainless steel, satin finishing - lower deck with bottle holder.** – 4 ruote pivotanti, senza freno - piano superiore in acciaio inox 18-10, satinato - vano inferiore con portabottiglie.



**Hors d'oeuvre trolley**

Carrello antipasti  
Vorspeisewagen  
Chariot à hors d'oeuvres  
Carro entremeses

art.	dim. cm.	Kg.	color	col.
18878-00	122x62x106	38	rosewood	●
18878M00	122x62x106	38	mahogany	●
18878N00	122x62x106	38	walnut	●
18878R00	122x62x106	38	oak	●

**4 swivel casters, 2 with brakes – methacrylate revolving cloche – hors d'oeuvre inserts carrying deck in 18-10 s/s with protection ring - 9 hors d'oeuvre glass inserts, mm 123x203. Upon request, the trolley can be supplied equipped with intermediate shelf.** – 4 ruote pivotanti, 2 con freno - cupola in metacrilato con apertura a scomparsa - piano porta-vaschette antipasti in acciaio inox 18-10 con barriera perimetrale - 9 vaschette antipasti in vetro, dim. mm 123 x 203. Su richiesta è possibile fornire il carrello dotato di piano intermedio.



**Cooled hors d'oeuvre trolley**

Carrello antipasti, refrigerato  
Vorspeisewagen, gekühlt  
Chariot à hors d'oeuvres, réfrigéré  
Carro entremeses, refrigerado

art.	dim. cm.	Kg.	color	col.
18879-00	122x62x106	38	rosewood	●
18879M00	122x62x106	38	mahogany	●
18879N00	122x62x106	38	walnut	●
18879R00	122x62x106	38	oak	●

**4 swivel casters, 2 with brakes - methacrylate revolving cloche – eutectic pads container with 18-10 stainless steel cover - 8 eutectic pads 2,2 lbs each, mm 170x200 - 9 hors d'oeuvre glass inserts, mm 123x203. Upon request, the trolley can be supplied equipped with intermediate shelf. – 4 ruote pivotanti di cui 2 con freno - cupola in metacrilato, con apertura a scomparsa - copertura vasca per contenitori eutettici in acciaio inox 18-10 - 8 contenitori eutettici da kg 1 cadauno, dim. mm 170 x 200 - 9 vaschette antipasti in vetro, dim. mm 123 x 203. Su richiesta è possibile fornire il carrello dotato di piano intermedio.**



**Patisserie trolley**

Carrello pasticceria Omicron  
Kuchen-/Nachspeisewagen  
Chariot à pâtisserie  
Carro postres

art.	dim. cm.	Kg.	color	col.
18880-00	113x56,5x104	57	rosewood	●
18880M00	113x56,5x104	57	mahogany	●
18880N00	113x56,5x104	57	walnut	●
18880R00	113x56,5x104	57	oak	●

**Methacrylate revolving cloche, bifrontal rotation – 4 swivel casters, 2 with brakes - 1 upper fixed deck in metacrilat mm 200x750 - 1 upper removable deck in metacrilat mm 400x750 – 2 revolving plate racks in 18-10 stainless steel - 2 lower wooden decks. – Cupola tonda in metacrilato, montata su guide laterali, che ne permettono la rotazione nei due sensi - 4 ruote pivotanti di cui 2 con freno - 1 piano fisso in metacrilato mm 200x750 - 1 piano mobile in metacrilato mm 400x750 - 2 portapiatti ribaltabili in acciaio inox 18-10 - 2 piani d'appoggio inferiori in legno.**



**Cake and cheese trolley**

Carrello dolci-formaggi  
Dessert-/Käsewagen  
Chariot à fromages et desserts  
Carro postres/quesos

art.	dim. cm.	Kg.	color	col.
18882-00	122x62x106	38	rosewood	●
18882M00	122x62x106	38	mahogany	●
18882N00	122x62x106	38	walnut	●
18882R00	122x62x106	38	oak	●

**4 swivel casters, 2 with brakes - methacrylate revolving cloche - beech texwood cutting board mm 728x424 - revolving plate rack in 18-10 stainless steel. Upon request, the trolley can be supplied equipped with intermediate shelf. – 4 ruote pivotanti di cui 2 con freno - cupola in metacrilato, con apertura a scomparsa - tagliere in texwood faggio naturale mm 728 x 424 - portapiatti ribaltabile in acciaio inox 18-10. Su richiesta è possibile fornire il carrello dotato di piano intermedio.**



**Cooled cake trolley**

Carrello dolci, refrigerato  
Dessertwagen, gekühlt  
Chariot à desserts, réfrigéré  
Carro postres, refrigerado

art.	dim. cm.	Kg.	color	col.
18884-00	122x62x106	47,5	rosewood	●
18884M00	122x62x106	47,5	mahogany	●
18884N00	122x62x106	47,5	walnut	●
18884R00	122x62x106	47,5	oak	●

**4 swivel casters, 2 with brakes - metacrilat revolving cloche – eutectic pads container with 18-10 stainless steel cover - 8 eutectic pads 2,2 lbs each, mm 170x200 - revolving plate rack in 18-10 stainless steel. Upon request, the trolley can be supplied equipped with intermediate shelf. – 4 ruote pivotanti di cui 2 con freno - cupola in metacrilato, con apertura a scomparsa - vaschetta porta contenitori eutettici con copertura in acciaio inox 18-10 - 8 contenitori eutettici da kg 1 cadauno, mm 170x200 - portapiatti ribaltabile in acciaio inox 18-10. Su richiesta è possibile fornire il carrello dotato di piano intermedio.**





**Cooled mini cheese trolley**

Carrello mini-formaggi, refrigerato  
Käsewagen, gekühlt, Mini-Ausführung  
Chariot à fromages, réfrigéré, mini  
Mini carro quesos, refrigerado

art.	dim. cm.	Kg.	color	col.
18895-00	77,5x51x94	16,5	rosewood	●
18895M00	77,5x51x94	16,5	mahogany	●
18895N00	77,5x51x94	16,5	walnut	●
18895R00	77,5x51x94	16,5	oak	●

**4 swivel casters without brakes - metacrilat roll-top cover, opening at 90° - eutectic pads container with stainless steel cover (eutectic pads incl.) - 1 removable cutting board, GN 1/1 - revolving plate rack in stainless steel. - 4 ruote pivotanti senza freno - cupola in metacrilato, con apertura a 90° - vaschetta porta contenitori eutettici (eutettici inclusi) con copertura in acciaio inox - 1 tagliere mobile, GN 1/1 - portapiatti ribaltabile in acciaio inox.**



**Wine trolley**

Carrello vini  
Weinwagen  
Chariot à vins  
Carro de vinos

art.	dim. cm.	Kg.	color	col.
18897-00	122x62x92	39	rosewood	●
18897M00	122x62x92	39	mahogany	●
18897N00	122x62x92	39	walnut	●
18897R00	122x62x92	39	oak	●

**4 swivel casters, 2 with brakes - upper deck with stainless steel bottle holder ring - bottle caps and wine card compartment - 6 compartments for bottle coolers (bottle coolers included) - glass rack, deck downside - lower deck with bottle rack, 12 compartments. - 4 ruote pivotanti di cui 2 con freno - barriera porta bottiglie in acciaio inox - contenitore per tappi e carta vini - vano con 6 glacette (glacette incluse) - rastrelliera porta bicchieri, sotto piano carrello - piano inferiore con rastrelliera porta bottiglie, 12 posti.**



**Liqueur trolley**

Carrello liquori  
Aperitif-/Digestivwagen  
Chariot à liqueurs  
Carro licores

art.	dim. cm.	Kg.	color	col.
18889-00	124x68,5x104	37	rosewood	●
18889M00	124x68,5x104	37	mahogany	●
18889N00	124x68,5x104	37	walnut	●
18889R00	124x68,5x104	37	oak	●

**4 swivel casters, 2 with brakes - bottle holder protection ring in 18-10 stainless steel. - 4 ruote pivotanti di cui 2 con freno - barriera portabottiglie in acciaio inox 18-10.**



**Serving trolley**

Carrello servizio  
Servierwagen  
Chariot à servir  
Carro de servicio

art.	dim. cm.	Kg.	color	col.
18891-00	122x58,5x89,5	35,5	rosewood	●
18891M00	122x58,5x89,5	35,5	mahogany	●
18891N00	122x58,5x89,5	35,5	walnut	●
18891R00	122x58,5x89,5	35,5	oak	●

**4 swivel casters, 2 with brakes - removable upper deck and wooden drawer. Upon request, the trolley can be supplied equipped with intermediate shelf. - 4 ruote pivotanti di cui 2 con freno - piano estraibile e cassetto in legno. Su richiesta è possibile fornire il carrello dotato di piano intermedio.**





**Sherbet/ice cream trolley**

Carrello sorbetti  
Sorbetwagen  
Chariot à sorbets/glacés  
Carro sorbetes

art.	dim. cm.	Kg.	color	col.
18893-00	122x62x93	43	rosewood	●
18893M00	122x62x93	43	mahogany	●
18893N00	122x62x93	43	walnut	●
18893R00	122x62x93	43	oak	●

**4 swivel casters, 2 with brakes - 4 18-10 stainless steel insulated sherbet holders (lt 1,2 each) - flatware drawer - revolving plate rack and ice cream scoops holder in stainless steel.** – 4 ruote pivotanti di cui 2 con freno - 4 sorbettiere termiche in acciaio inox 18-10 da lt 1,2 cadauna - cassetto portaposate - portapiatti ribaltabile e portapalette-gelato in acciaio inox 18-10.



**Round trolley**

Carrello tondo  
Servierwagen, rund  
Chariot rond  
Carro redondo

art.	Ø cm.	h. cm.	Kg.	color	col.
18888-00	60	89,5	23	rosewood	●
18888M00	60	89,5	23	mahogany	●
18888N00	60	89,5	23	walnut	●
18888R00	60	89,5	23	oak	●

**4 swivel casters without brakes – removable upper deck - perimeter barrier.**  
4 ruote pivotanti, senza freno - piano d'appoggio laterale estraibile - barriera perimetrale.



PP

**Serving trolley**

Carrello servizio  
Servierwagen  
Chariot à servir  
Carro de servicio

art.	dim. cm.	col.
49995-04	97x51x99	●

**Swivel casters for easy manoeuvrability. Ergonomic handles, high load capacity 135 kg (45 kg per shelf). Ultra-quiet mark-resistant casters.**  
Maniglie ergonomiche arrotondate, pannelli laterali e bordo paraurti arrotondato. Portata 135 kg (45 kg per ripiano). Ruote girevoli, antitraccia e silenziose.



W

**Breakfast tray with legs**

Vassoio colazione con gambe  
Frühstückstablett mit Beinen  
Plateau petit déjeuner avec jambes  
Bandeja desayuno con patas

art.	dim. cm.	col.
19902-38	58,5x38,5x30	●

Wengè.



W

**Room service tray**

Vassoio room service  
Zimmerservice-Tablett  
Plateau room-service  
Bandeja room service

art.	dim. cm.	col.
19901-35	52x35	●
19901-40	60x40	●
19901-47	71x47	●

**Dark walnut.** – Noce scuro.

**NEW SERVICE CONCEPT**



**2-tier service trolleys with hygienic plexiglas dome cover double side opening and 4 standard swivel wheels, 2 with brake. A new way of serving food safely and fighting COVID 19 by clearly dividing the kitchen side and the service side to avoid contamination and have the most hygienic service possible.**

Carrelli di servizio a 2 piani dotati di cupola igienica in plexiglas apribile sui 2 lati e 4 ruote girevoli di cui 2 con freno. Un nuovo modo di servire gli alimenti in sicurezza e combattere COVID 19 dividendo chiaramente il lato cucina e il lato servizio per evitare contaminazioni e avere il servizio più igienico possibile.



**Serving trolley**

Carrello servizio  
Servierwagen  
Chariot à servir  
Carro de servicio

art. dim. cm.

49996-00 89x47x103

**Chromed structure, shelves elm color, perimeter barrier lower deck, sliding plate shelf upper deck, wheels Ø 100 mm.**

Struttura cromata, ripiani color olmo, spondine di contenimento piano inferiore, pianetto estraibile, ruote Ø 100 mm.



**Serving trolley**

Carrello servizio  
Servierwagen  
Chariot à servir  
Carro de servicio

art. dim. cm.

49996-01 89x47x103

**Chromed structure, shelves elm color, wheels Ø 100 mm.**

Struttura cromata, ripiani color olmo, ruote Ø 100 mm.



**Serving trolley**

Carrello servizio  
Servierwagen  
Chariot à servir  
Carro de servicio

art. dim. cm.

49996-05 89x47x103

**Painted structure, shelves grey color, wheels Ø 100 mm.**

Struttura verniciata, ripiani colore grigio, ruote Ø 100 mm.



## IN-ROOM DINING SOLUTIONS



A range of service tables and trolleys designed to allow guests to comfortably and safely receive and consume breakfast or dinner in their room. Hot boxes made of AISI 304 stainless steel with double insulated wall. Analogic thermostat 30-90°C with indicator light. Equipped with two inner height-adjustable grids. Suitable for dishes up to Ø 32 cm. Refrigerated boxes made of AISI 304 stainless steel with double insulated wall with chilling pack -32°C inserted in a condensate collector basket placed on the upper grid. Chill for about 5 hours. Room service tables: chrome tube structure, 2 castors with brake. Top Ø 90 cm made of CDF (Compact Density Fibreboard). Can carry up to 2 boxes.

Una gamma di tavoli e carrelli per il servizio in camera per permettere agli ospiti di ricevere e consumare comodamente e in piena sicurezza la colazione o la cena in stanza. Box termici in acciaio inox AISI 304 a doppia parete coibentata. Termostato analogico 30-90°C con spia luminosa di funzionamento. Forniti con due griglie interne regolabili in altezza. Idonei per piatti fino a Ø 32 cm. Box refrigerati in acciaio inox AISI 304 a doppia parete coibentata. Refrigerazione a mezzo di una piastra eutettica -32°C inserita in un cesto di raccolta posizionato sulla griglia superiore. Raffreddare per c.ca 5 ore. Tavolini: struttura in tubo cromato, 2 ruote con freno. Piano Ø 90 cm in CDF (Compact Density Fibreboard). Possono trasportare fino a 2 box.



### Thermic hot box

Box termico  
Speisen-Kaste  
Caisson thermique  
Cajón térmico

art.	dim. cm.	W
44094-00	38x40,5x51,2	500

### Refrigerated box

Box refrigerato  
Speisen-Kaste  
Caisson réfrigéré  
Cajón refrigerado

art.	dim. cm.
44094R00	38x40,5x51



### Room service table

Tavolino room service  
Zimmerservice-Tisch  
Table de restauration en chambre  
Carrito de servicio de habitaciones

art.	Ø cm.	h. cm.
44094-01	90/54,6	77



### Room service table with hot box

Tavolino room service con hot box  
Zimmerservice-Tisch mit Hot Box  
Table de restauration en chambre avec hot box  
Carrito de servicio de habitaciones con hot box

art.	Ø cm.	h. cm.	W
44094-02	90/54,6	77	500

44094-00 + 44094-01.

With fold down flaps for easy crossing of doors and lifts.  
Con flaps pieghevoli per attraversare porte e ascensori.



**ROOM SERVICE**



**Room service table**

Tavolino room service  
Zimmerservice-Tisch  
Table de restauration en chambre  
Carrito de servicio de habitaciones

art. Ø cm. h. cm. closed/chiuso  
44094-03 90/54,6 78,6 74x54x117

**With fold down flaps for easy crossing of doors and lifts. With capsizable top for stacking when not in use.** – Con flaps pieghevoli per attraversare porte e ascensori. Ribaltabile e impilabile quando non in uso.



**Room service table with hot box**

Tavolino room service con hot box  
Zimmerservice-Tisch mit Hot Box  
Table de restauration en chambre avec hot box  
Carrito de servicio de habitaciones con hot box

art. Ø cm. h. cm. W  
44094-04 90/54,6 78,6 500

**44094-00 + 44094-03.**



**Room service table**

Tavolino room service  
Zimmerservice-Tisch  
Table de restauration en chambre  
Carrito de servicio de habitaciones

art. Ø cm. h. cm. closed/chiuso  
44094-05 90/73 76 73x33x98

**With fold down flaps for easy crossing of doors and lifts. Foldable for saving space when not in use.** – Con flaps pieghevoli per attraversare porte e ascensori. Pieghevole per ridurre l'ingombro quando non in uso.



**Room service table with hot box**

Tavolino room service con hot box  
Zimmerservice-Tisch mit Hot Box  
Table de restauration en chambre avec hot box  
Carrito de servicio de habitaciones con hot box

art. Ø cm. h. cm. W  
44094-06 90/73 76 500

**44094-00 + 44094-05.**



**Serving trolley**

Carrello servizio  
Servierwagen  
Chariot à servir  
Carro de servicio

art. des. dim. cm.  
49996-01 trolley 89x47x103  
44094-00 hot box 38x40,5x51,2  
44094R00 cold box 38x40,5x51

**With hygienic plexiglas dome cover double side opening. The trolley can be equipped with 2 hot and/or cold boxes. Ideal for maintaining the temperature of food and for the room service.** – Cupola igienica in plexiglas apribile sui 2 lati. Il carrello è equipaggiabile con 2 box termici caldi e/o freddi. Ideale per mantenere la temperatura delle portate e per il servizio in camera.



**Serving trolley**

Carrello servizio  
Servierwagen  
Chariot à servir  
Carro de servicio

art. des. dim. cm.  
49996-05 trolley 89x47x103  
44094-00 hot box 38x40,5x51,2  
44094R00 cold box 38x40,5x51

**With hygienic plexiglas dome cover double side opening. The trolley can be equipped with 2 hot and/or cold boxes. Ideal for maintaining the temperature of food and for the room service.** – Con cupola igienica in plexiglas apribile sui 2 lati. Il carrello è equipaggiabile con 2 box termici caldi e/o freddi. Ideale per mantenere la temperatura delle portate e per il servizio in camera.



# SERIES 14000

STORAGE & TRANSPORT  
STOCCAGGIO E TRASPORTO



Molded in one-piece with double-wall construction made of polypropylene. Resistant to shock, high temperatures and chemicals. Designed to give optimum protection to glass and chinaware as well as to maximise water circulation and drying in professional dishwasher. Easy and quickly stackable without tools or screws. Base racks have comfortable hand grips on all four sides facilitating handling.

Realizzati in polipropilene, stampati unipezzo a doppio spessore. Resistenti agli urti ed alte temperature, agenti chimici e residui alimentari. Concepiti per assicurare una protezione ottimale a bicchieri e stoviglie, il loro design permette inoltre una perfetta circolazione dell'acqua di lavaggio ed una rapida e perfetta asciugatura. Facili e veloci da impilare. Leggeri e maneggevoli, tutti i cestelli di base sono dotati di maniglie integrali su tutti i lati.





**9-Compartment base**

Cestello 9 bicchieri  
Grundkorb für 9 Gläser  
Panier de base 9 verres  
Cesta 9 compartimentos

art. mm.

14001-09 500x500x103

**Compartments / Scomparti 151x151x42 mm.  
ø max 151 mm.**



**9-Compartment extender**

Estensore per cestello 9 bicchieri  
Aufsatz zum Grundkorb für 9 Gläser  
Réhausse pour panier de base 9 verres  
Extensión 9 compartimentos

art. mm.

14003-09 500x500x45

**Compartments / Scomparti 151x151x88 mm.  
ø max 151 mm.**



**16-Compartment base**

Cestello 16 bicchieri  
Grundkorb für 16 Gläser  
Panier de base 16 verres  
Cesta 16 compartimentos

art. mm.

14001-16 500x500x103

**Compartments / Scomparti 112x112x88 mm.  
ø max 112 mm.**



**16-Compartment extender**

Estensore per cestello 16 bicchieri  
Aufsatz zum Grundkorb für 16 Gläser  
Réhausse pour panier de base 16 verres  
Extensión 16 compartimentos

art. mm.

14003-16 500x500x45

**Compartments / Scomparti 112x112x42 mm.  
ø max 112 mm.**



**25-Compartment base**

Cestello 25 bicchieri  
Grundkorb für 25 Gläser  
Panier de base 25 verres  
Cesta 25 compartimentos

art. mm.

14001-25 500x500x103

**Compartments / Scomparti 88x88x88 mm.  
ø max 88 mm.**



**25-Compartment extender**

Estensore per cestello 25 bicchieri  
Aufsatz zum Grundkorb für 25 Gläser  
Réhausse pour panier de base 25 verres  
Extensión 25 compartimentos

art. mm.

14003-25 500x500x45

**Compartments / Scomparti 88x88x42 mm.  
ø max 88 mm.**



**36-Compartment base**

Cestello 36 bicchieri  
Grundkorb für 36 Gläser  
Panier de base 36 verres  
Cesta 36 compartimentos

art. mm.

14001-36 500x500x103

**Compartments / Scomparti 73x73x88 mm.  
ø max 73 mm.**



**36-Compartment extender**

Estensore per cestello 36 bicchieri  
Aufsatz zum Grundkorb für 36 Gläser  
Réhausse pour panier de base 36 verres  
Extensión 36 compartimentos

art. mm.

14003-36 500x500x45

**Compartments / Scomparti 73x73x42 mm.  
ø max 73 mm.**



**49-Compartment base**

Cestello 49 bicchieri  
Grundkorb für 49 Gläser  
Panier de base 49 verres  
Cesta 49 compartimentos

art. mm.

14001-49 500x500x103

**Compartments / Scomparti 62x62x42 mm.  
ø max 62 mm.**





**49-Compartment extender**

Estensore per cestello 49 bicchieri  
 Aufsatz zum Grundkorb für 49 Gläser  
 Réhausse pour panier de base 49 verres  
 Extensión 49 compartimentos

art. mm.  
 14003-49 500x500x45

**Compartments / Scomparti 62x62x42 mm.  
 ø max 62 mm.**



**Open extender**

Estensore aperto  
 Universalrand ohne Einteilung  
 Réhausse sans cloisons  
 Extensión abierta

art. mm.  
 14004-00 500x500x42



**Rack cover**

Coperchio per cestelli  
 Deckel für Körbe  
 Couvercle à panier  
 Tapa para cestas

art. mm.  
 14011-00 505x505x25



**Open rack**

Cestello universale  
 Universal-Korb  
 Panier universel  
 Cesta universal

art. mm.  
 14010-00 500x500x103



**Cutlery rack**

Cestello per posate  
 Besteckkorb  
 Panier à couverts  
 Cesta para cubiertos

art. mm.  
 14006-00 500x500x103



**Plates & trays rack**

Cestello per piatti e vassoi  
 Tablett- u. Tellerkorb mit Fingern  
 Panier à plateaux et assiettes  
 Cesta para bandejas y platos

art. mm.  
 14008-00 500x500x103

**For 18 flat plates or 9 trays max. 460 mm.**  
 Per 18 piatti piani oppure 9 vassoi max. 460 mm.



**Tray rack, open**

Cestello per vassoi, aperto  
 Tablettkorb mit Fingern, offen  
 Panier à plateaux, ouvert  
 Cesta abierto para bandejas

art. mm.  
 14007-00 500x500x103

**For trays over 460 mm. Capacity 9 pcs.**  
 Per vassoi oltre 460 mm. Cap. 9 pz.



**Clip tags, 10-pcs set**

Etichette di identificazione, set 10 pz  
 Markierungsklipp, 10 Stk.  
 Clips, set 10 pièces  
 Etiquetas, set 10 piezas

art. mm.  
 14013-00 80x40



**Cutlery holder 8 compartments**

Cestello per posate 8 scomparti  
 Besteckkorb, 8 Unterteilungen  
 Panier à couverts 8 compartiments  
 Cesta para cubiertos

art. mm.  
 14015-08 426x206x150

**For 200/250 pcs cutlery. – Per 200/250 posate.**





**SS**

**Cutlery dispenser**  
Porta posate  
Besteckbehälter  
Réceptient à couverts  
Contenedor para cubiertos

art. cm.  
42587-04 26x30x20



**SS**

**Cutlery holder**  
Cestello porta posate  
Besteckbehälter  
Réceptient à couverts  
Cestillo para cubiertos

art. Ø cm. h. cm.  
42586-10 10 14



**PE**

**Cutlery holder**  
Cestello porta posate  
Besteckbehälter  
Réceptient à couverts  
Cestillo para cubiertos

art. Ø cm. h. cm.  
42586-09 9,5 13,5



**PP**

**Cutlery dispenser**  
Porta posate  
Besteckbehälter  
Réceptient à couverts  
Contenedor para cubiertos

art. cm.  
42585-06 54x33x13



**PE**

**Cutlery dispenser**  
Porta posate  
Besteckbehälter  
Réceptient à couverts  
Contenedor para cubiertos

art. cm. GN h. cm.  
42585-04 32,5x53 1/1 10



**PP**

**Cutlery box lid**  
Coperchio per porta posate  
Deckel für Besteckbehälter  
Couvercle pour réceptient à couverts  
Tapa para contenedor cubiertos

art. cm.  
42585-00 32,5x53x2

**Fits/Per: 42585-04.**



**Dolly with handle**  
Carrello con maniglione  
Transportwagen mit Griff  
Chariot avec poignée  
Carretilla con manillar

art. cm. Kg.  
44023-00 54x54x75 10

**Polypropylene base. – Base in PP.**



**Dolly without handle**  
Carrello senza maniglione  
Transportwagen ohne Griff  
Chariot sans poignée  
Carretilla sin manillar

art. cm. Kg.  
44024-00 54x54 8,5

**Polypropylene base. – Base in PP.**



**Dolly, aluminum/ABS**  
Carrello, alluminio/ABS  
Transportwagen, Aluminium/ABS  
Chariot, aluminium/ABS  
Carro, aluminio/ABS

art. cm.  
44975C50 51x51





SS

**Dolly with handle**  
 Carrello con maniglione  
 Transportwagen mit Griff  
 Chariot avec poignée  
 Carretilla con manillar

art. cm.  
 44025-50 55x55x9

**Removable handle, with drip and drain plug. Load 60 kg.** – Manico estraibile, tappo di scarico. Carico 60 kg.



**Dust cover**  
 Copertura protettiva  
 Schutzhülle  
 Housse de protection  
 Cuberta protectora

art. cm.  
 44009-00 55x55x122



SS

**Trolley 3 levels**  
 Carrello 3 livelli  
 3-stöckiger Wagen  
 Chariot à 3 étages  
 Carro 3 pisos

art. cm.  
 44020-21 100x50x178,5

**Suitable for 24 racks.**  
 Carico verticale per 24 cestelli.



PP

**Multipurpose box**  
 Recipiente  
 Behälter  
 Conteneur multiservice  
 Contenedor

art. cm.  
 44031-04 52x39x12,7  
 44031-05 52x39x17,7

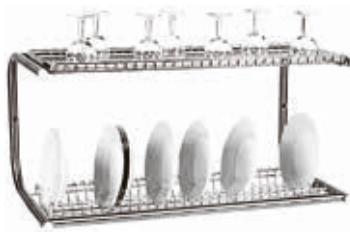

SS

**Wall draining rack**  
 Scolapiatti a muro  
 Wand-Trockengestell  
 Egouttoir au mur  
 Escurridor mural de platos

art. cm.  
 44029-00 87x30x20

**Load/Carico: 70 kg.**



**Wire dish rack**  
 Porta piatti in filo metallo/rilsan  
 Tellergestell  
 Porte-assiettes

**Porta platos**

art.	Ø cm.	h. cm.
44047-17	17	30
44047-19	19	30
44047-22	22	30
44047-25	25	30
44047-28	28	30



SS

**Dish dolly**  
 Carrello portapiatti  
 Teller-Transportwagen  
 Chariot porte-assiettes  
 Carro porta platos

art. cm.  
 44027-00 74x61x81

**Load/Carico max: 240 kg.**



PE

**Adjustable dish dolly**  
 Carrello portapiatti regolabile  
 Teller-Transportwagen, einstellbar  
 Chariot de stockage d'assiettes réglable  
 Carro ajustable para platos

art. cm. Kg.  
 49304-06 73x73x82 28

**With dust cover and 4 dividers. Dishes Ø cm 18-32,5 capacity 180/480 pcs. 2 wheels with brake.**  
 Con copertura vinilica e 4 divisori. Per piatti Ø cm 18-32, capienza 180/480 pz. 2 ruote con freno.

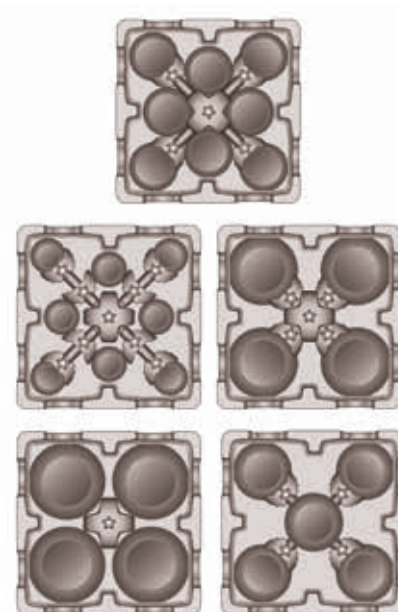

**CROCKERY TRANSPORT BOX**  
CONTENITORE PER IL TRASPORTO DI STOVIGLIE

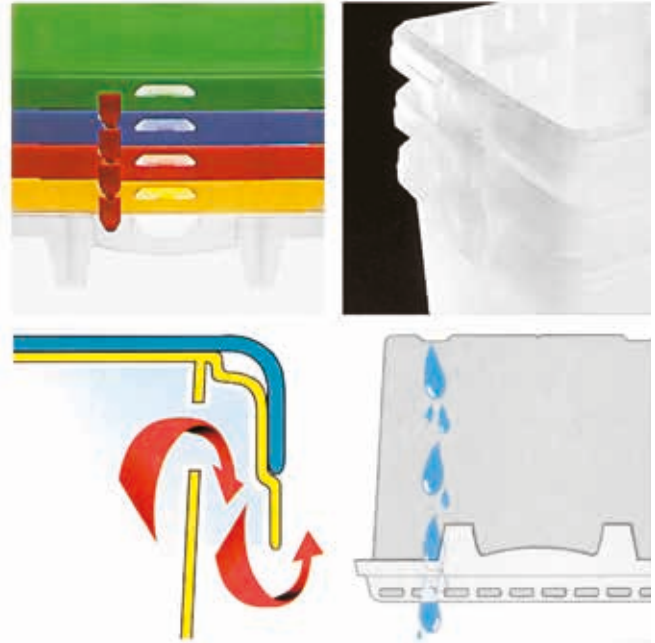

Clear polypropylene construction, full compliance with food contact requirements. A removable tower insert provides total flexibility. Strong, it prevents dish breakage in transport. Dimensions suitable to EURO-pallets. Lids are tightly fitting, hygienic, dish-washer safe. Covers available in different colors, assure easy and quick content identification. Stackable once empty, their strongness provides high loading density once full. Ventilation holes assure constant air circulation. Design studied to enable water flow while washing.

Contenitori in polipropilene trasparente per alimenti. Estremamente resistenti alle sollecitazioni, offrono protezione sicura nel trasporto. Dimensioni adatte a EURO-pallets. Adatti al lavaggio in lavastoviglie, design studiato per consentire il defluire dell'acqua. Coperchi di colore diverso facilitano l'individuazione del contenuto. Impilabili, a pieno la loro robustezza consente un'elevata capacità di sovrapposizione. Fessure di aerazione per un costante ricambio d'aria.



**Storage box**  
Contenitore  
Korb  
Panier  
Contenedor

art.	cm.	lt.
44040-40	40x40x31,5	32



**Base insert**  
Fondo piatto  
Flach-Einsatz  
Plateau double fond  
Base plana

art.	cm.
44042-00	40x40



**Cross insert**  
Inserto croce  
Kreuz-Einsatz  
Cloison à croix  
Separador a cruz

art.	cm.
44043-00	40x40



**Cover**  
Coperchio  
Deckel  
Couvercle  
Tapa

art.	col.
44041-00	○
44041-01	●
44041-03	●



**Cover**  
Coperchio  
Deckel  
Couvercle  
Tapa

art.	col.
44041-04	●
44041-05	●



**Tower insert**  
Tubo fermapiatti  
Rohr-Einsatz  
Tuyau  
Tubo

art.
44044-00

## SQUARE & ROUND CONTAINERS CONTENITORI QUADRATI & ROTONDI



**Space-saving SQUARE containers.** In transparent anti-breaking material to identify the contents. Graduated measurements: red for US sizes and blue for liters. Resistant handles. Drainage holes. They withstand temperatures between  $-40^{\circ}\text{C}$  and  $100^{\circ}\text{C}$ . Lids with hermetic pressure closure and corner tab for easy removal.

**ROUND stackable containers.** Reinforced rims. Drainage holes. They withstand temperatures between  $-28^{\circ}\text{C}$  and  $65^{\circ}\text{C}$ . Dishwasher safe. Tight-fitting lids with double barrier and opening flap in the corner. Writing area on the cover to specify date and content.

Contenitori QUADRATI salvaspazio. In materiale infrangibile, trasparente per identificare il contenuto. Misurazioni graduate: rosse per le misure USA e blu per i litri. Impugnature resistenti. Fori di drenaggio. Resistono a temperature comprese fra i  $-40^{\circ}\text{C}$  e i  $100^{\circ}\text{C}$ . Coperchi a chiusura ermetica a pressione e linguetta per una rimozione agevole.

Contenitori ROTONDI impilabili. Bordi rinforzati. Fori di drenaggio. Resistono a temperature comprese fra i  $-28^{\circ}\text{C}$  e i  $65^{\circ}\text{C}$ . Lavabili in lavastoviglie. I coperchi sono a chiusura ermetica con doppia barriera e linguetta di apertura nell'angolo. Consentono l'indicazione della data e del contenuto in un'apposita area di scrittura.



### Food container, copolyester

Contenitore per alimenti, copoliestere  
Vorratsdosen, Copoliéster  
Conteneur pour aliments, copolyester  
Contenedor para alimentos, copolyester

art.	cm.	lt.
44620-01	22x21x7	1,9
44620-02	22x21x12	3,8
44620-03	22x21x17,5	5,7
44620-04	22x21x22	7,6



### Food container, copolyester

Contenitore per alimenti, copoliestere  
Vorratsdosen, Copoliéster  
Conteneur pour aliments, copolyester  
Contenedor para alimentos, copolyester

art.	cm.	lt.
44620-05	29x27x19	11,4
44620-06	29x27x30	17,0
44620-07	29x27x36,5	20,8



PE

### Square lid

Coperchio quadrato  
Deckel, viereckig  
Couvercle carré  
Tapa cuadrada

art.	cm.
44620-14	22x21
44620-17	29x27



PP

### Food container

Contenitore per alimenti  
Vorratsdosen  
Conteneur pour aliments  
Contenedor para alimentos

art.	Ø cm.	h. cm.	lt.
44625-03	25	19,5	5,7
44625-04	25	27,0	7,6
44625-05	33	20,5	11,4
44625-06	33	30,0	17,0



PP

### Food container

Contenitore per alimenti  
Vorratsdosen  
Conteneur pour aliments  
Contenedor para alimentos

art.	Ø cm.	h. cm.	lt.
44625-07	33	35,5	20,8
44625-08*	33	35,5	20,8

\*With handle. – Con manico.



PE

### Round lid

Coperchio rotondo  
Deckel, rund  
Couvercle rond  
Tapa redonda

art.	Ø cm.	col.
44625-26	25	●
44625-34	33	●





PC

**Food container**

Contentitore per alimenti  
Nahrungsmittel-Behälter  
Conteneur pour aliments  
Contenedor para alimentos

art.	cm.	lt.
49384-03	45,7x30x23	19,0
49384-04	45,7x66x9	19,0
49384-05	45,7x66x15	32,3
49384-06	45,7x66x23	47,0
49384-07	45,7x66x38	81,5



PC

**Drain tray**

Vasca di drenaggio  
Abtropf-Behälter  
Conteneur perforé  
Contenedor para colar

art.	cm.
49384-11	45,7x66x12



PC

**Lid**

Coperchio  
Deckel  
Couvercle  
Tapa

art.	cm.
49384-14	45,7x30
49384-15	45,7x66



PP

**Food container**

Contentitore per alimenti  
Nahrungsmittel-Behälter  
Conteneur pour aliments  
Contenedor para alimentos

art.	cm.	lt.
49382-10	30x38x21,5	10,0
49382-23	60x49x43	23,5
49382-47	60x29x43	47,0



PP

**Storage container**

Carrello per derrate alimentari  
Fahrbares Nahrungsmittelbehälter  
Chariot mobile de stockage  
Contenedor para hortalizas

art.	cm.	lt.
49381-01	74x33,5x71	79,0
49381-02	75x39,5x71	97,5
49381-03	75,5x45,5x71	116



PE

**Container, round**

Contentitore tondo  
Behälter, rund  
Conteneur, rond  
Contenedor redondo

art.	Ø cm.	h. cm.	lt.
49373-01	39,7	43,5	37,9
49373-02	49,5	58,1	75,7
49373-03	55,9	69,2	121,1
49373-04	67,3	83,8	208,2



PE

**Lid, round**

Coperchio tondo  
Deckel, rund  
Couvercle, rond  
Tapa redonda

art.	Ø cm.	h. cm.
49373-11	40,6	2,5
49373-12	50,5	3,2
49373-13	56,5	3,5
49373-14	67,9	5,1



PE

**Dolly**

Supporto mobile  
Wagen  
Chariot  
Soporte móvil

art.	Ø cm.	h. cm.
49373-90	46,4	17

**Load/Carico: 113,4 kg.**



SS

**Sink trolley**

Carrello vasca  
Obst/Gemüsewaschwagen  
Chariot à évier  
Carro-cuba lavado verduras

art.	cm.	lt.
44028-19	80x60x75	190

**Tub with tap, brushed finish. Stamped bottom watertight, without edges.** – Vasca con rubinetto, finitura spazzolata. Fondo stampato a tenuta stagna, privo di spigoli.





**Bread basket**

Cesto pane  
Brot-Korb  
Corbeille à pain  
Cesta pan

art.	cm.	lt.
44982-04	57x36x34	40
44982-06	66x45x35	60
44982-10	78x52x40	100



**Space saving box with cover**

Contenitore con coperchio  
Behälter mit Deckel  
Récipient avec couvercle  
Contenedor con tapa

art.	cm.
44033-23	66x45x23
44033-38	67x46x38



**Gastronorm basket**

Cesto gastronorm  
Gastronorm-Korb  
Panier gastronorme  
Cesta gastronorm

art.	cm.
44034-11	59x39x19,5

**STACKABLE CONTAINERS**  
CONTENITORI SOVRAPPONIBILI



**Stackable containers, external dimensions 600x400 mm and 400x300 mm, they perfectly fit to 800x1200 mm EUR pallets and to 1000x1200 mm. Available in different heights and versions. High density polyethylene HDPE. A thermoplastic that offers excellent impact resistance at low temperatures (from -30°C to +70°C).**

Contenitori sovrapponibili con dimensioni esterne di mm 600x400 e 400x300 perfettamente pallettizzabili su pallet EUR mm 800x1200 e 1000x1200. Disponibili in diverse altezze e versioni. Polietilene alta densità HDPE. Uno dei materiali termoplastici più dotato di resistenza all'impatto con basse temperature (da -30°C a +70°C).



**Container**

Contenitore  
Behälter  
Conteneur  
Contenedor

art.	cm.	lt.
44511E21	60x40x10	21
44511E63	60x40x32	63
44511E90	60x40x45	90

**Solid bottom and sides. – Fondo e pareti chiuse.**



**Container**

Contenitore  
Behälter  
Conteneur  
Contenedor

art.	cm.	lt.
44512E12	60x40x7	12
44512E21	60x40x10	21

**Solid bottom and perforated sides.**  
Fondo chiuso e pareti forate.



**Container**

Contenitore  
Behälter  
Conteneur  
Contenedor

art.	cm.	lt.
44513E12	60x40x7	12
44513E21	60x40x10	21

**Perforated bottom and sides.**  
Fondo e pareti forate.





PP

**Lid**  
Coperchio  
Deckel  
Couvercle  
Tapa

art.	cm.
41763-00	60x40x2



PP

**Lid**  
Coperchio  
Deckel  
Couvercle  
Tapa

art.	cm.
41763-30	40x30x2



**Container**  
Contentitore  
Behälter  
Conteneur  
Contenedor

art.	cm.	lt.
44521E10	40x30x12	10

**Solid bottom and sides. – Fondo e pareti chiuse.**



**Container**  
Contentitore  
Behälter  
Conteneur  
Contenedor

art.	cm.	lt.
44521-16	40x30x17	16
44521-21	40x30x22	21
44521-31	40x30x32	31

**Solid bottom and sides. – Fondo e pareti chiuse.**



**Container**  
Contentitore  
Behälter  
Conteneur  
Contenedor

art.	cm.	lt.
44511-27	60x40x15	27
44511-34	60x40x17	34
44511-38	60x40x20	38
44511-42	60x40x22	42
44511-63	60x40x32	63
44511-90	60x40x45	90

**Solid bottom and sides. – Fondo e pareti chiuse.**



**Container**  
Contentitore  
Behälter  
Conteneur  
Contenedor

art.	cm.	lt.
44522E10	40x30x12	10

**Solid bottom and perforated sides.  
Fondo chiuso e pareti forate.**



**Container**  
Contentitore  
Behälter  
Conteneur  
Contenedor

art.	cm.	lt.
44522-16	40x30x17	16
44522-21	40x30x22	21
44522-31	40x30x32	31

**Solid bottom and perforated sides.  
Fondo chiuso e pareti forate.**



**Container**  
Contentitore  
Behälter  
Conteneur  
Contenedor

art.	cm.	lt.
44512-34	60x40x17	34
44512-42	60x40x22	42
44512-63	60x40x32	63
44512-90	60x40x45	90

**Solid bottom and perforated sides.  
Fondo chiuso e pareti forate.**



**Container**  
Contentitore  
Behälter  
Conteneur  
Contenedor

art.	cm.	lt.
44513-34	60x40x17	34
44513-38	60x40x20	38
44513-54	60x40x29	54
44513-63	60x40x32	63
44513-90	60x40x45	90

**Perforated bottom and sides.  
Fondo e pareti forate.**

## POLYPROPYLENE CONTAINERS CONTENITORI POLIPROPILENE



They do not hand over odours or flavours to foods. Easy to wash and disinfect after use. Light and free of protrusions and sharp edges. Resistant, hygienic, economic, 100% recyclable, without CFC. Suitable for industrial washing and disinfection with detergents and disinfectants, hot water, and wet vapour up to 110°C (HACCP System). Suitable to protect food thermal stresses.

Non cedono odori e sapori agli alimenti, facilmente lavabili e sanificabili. Leggeri e privi di sporgenze e spigoli vivi. Resistenti, igienici, ecologici e riciclabili al 100%, senza CFC. Compatibili al lavaggio e alla disinfezione industriale con detergenti e disinfettanti, acqua calda e vapore umido fino a 110°C (HAACCP System). Idonei a proteggere gli alimenti da sollecitazioni termiche.



### Insulated container POWERBOX

Contentitore isotermico  
Thermobehälter  
Conteneur isotherme  
Contenedor isotérmico

art.	cm.	lt.
44961-05	64,5x40x31,5	45



### Insulated container UNIVERSAL PN

Contentitore isotermico  
Thermobehälter  
Conteneur isotherme  
Contenedor isotérmico

art.	cm.	lt.
44986-12	61x43x20	24,0
44986-17	61x43x25	33,8
44986-21	61x43x29,5	42,8
44986-28	61x43x36,5	56,7



### Insulated container GN 1/2

Contentitore isotermico  
Thermobehälter  
Conteneur isotherme  
Contenedor isotérmico

art.	cm.	lt.
44972-20	41,5x32x28,5	20,3
44972-25	41,5x32x32	21,6
44972-33	41,5x32x40	31,2



### Insulated container GN 1/1

Contentitore isotermico  
Thermobehälter  
Conteneur isotherme  
Contenedor isotérmico

art.	cm.	lt.
44970-10	60x40x17	20,2
44970-15	60x40x23	31,2
44970-20	60x40x27	38,6
44970-34	60x40x34,5	52,3



### OPTIONAL 44970 - Sling & dolly

Imbragature e carrello  
Gurt und Wagen  
Sangle et chariot  
Correa y carro

art.	cm.
44987C62	62x42
44973-10	sling
44973-20	sling



### Insulated container PLUS GN 1/1

Contentitore isotermico  
Thermobehälter  
Conteneur isotherme  
Contenedor isotérmico

art.	cm.	lt.
44978-10	68x44,5X20	24,9
44978-20	68x44,5X30	45,6



### Insulated pastry container

Contentitore isotermico pasticceria  
Konditorei-Thermobehälter  
Conteneur isotherme à pâtisserie  
Contenedor isotérmico para pastelería

art.	cm.	lt.
44974-21	68,5x48,5x27	55,8
44974-27	68,5x48,5x33	71,7
44974-31	68,5x48,5x37	82,3



### Insulated container HANDTOP

Contentitore isotermico  
Thermobehälter  
Conteneur isotherme  
Contenedor isotérmico

art.	cm.	lt.
44961-06	71,5x40x31,5	45

### Incorporated ergonomic handles. For Gastronorm 1/1 or submultiples.

Maniglie ergonomiche incorporate. Trasporta Gastronorm da 1/1 o sottomultipli.



### Insulated container TROLLEYBOX

Contentitore isotermico  
Thermobehälter  
Conteneur isotherme  
Contenedor isotérmico

art.	cm.	lt.
44961-04	42x42x60	60







**Insulated container BOXSHOP**

Contentitore isotermico  
Thermobehälter  
Conteneur isotherme  
Contenedor isotérmico

art.	cm.	lt.
44961-02	41,5x32x40	31,2



**Insulated container PIZZABOX**

Contentitore isotermico  
Thermobehälter  
Conteneur isotherme  
Contenedor isotérmico

art.	cm.	lt.
44961-03	42x42x34,5	36

**With steam release system.**  
Con sistema di rilascio del vapore.



**Insulated container POPTER GN 1/1**

Contentitore isotermico  
Thermobehälter  
Conteneur isotherme  
Contenedor isotérmico

art.	cm.	lt.
44987-11	65x50x61	83

**For GN 1/1 or submultiples. 12 guides.**  
Per GN 1/1 o sottomultipli. 12 guide.



**Insulated container PORTER MAXI**

Contentitore isotermico  
Thermobehälter  
Conteneur isotherme  
Contenedor isotérmico

art.	cm.	lt.
44987-60	72x60x63	128

**Guides/Guide: 9**



**Insulated container GN CRYSTAL**

Contentitore isotermico  
Thermobehälter  
Conteneur isotherme  
Contenedor isotérmico

art.	cm.	lt.
44968-00	60x40x30	45,4

**Inside crystallized and therefore perfectly smooth, rigid and waterproof.**  
Interno cristallizzato perfettamente liscio, rigido e impermeabile.



**Dolly, aluminum/ABS**

Carrello, alluminio/ABS  
Fahrgestell, Aluminium/ABS  
Chariot, aluminium/ABS  
Carro, aluminio/ABS

art.	cm.	for/per
44975C50	58,5x58,5	44975-50
44987C11	68x52	44987-11
44987C60	75x61	44987-60
44987C62	62x42	44968-00



**Eutectic pad**

Accumulatore di freddo  
Kühlakku  
Cartouche eutectique  
Placa eutética

art.	cm.	GN
44979-04	32,5x26,5x3	1/2
44979-05	53x32,5x3	1/1
44979-06	60x40x3	-

**0/-21°C.**



**Heat accumulator**

Accumulatore di caldo  
Wärmespeicher  
Accumulateur de chaleur  
Acumulador de calor

art.	cm.	GN
44979-02	53x32,5x3	1/1

**0/+85°C.**



**Insulated box**

Box isotermico  
Thermobehälter  
Conteneur isotherme  
Contenedor individual isotérmico

art.	cm.
44976-04	44x38x12

**3 sections for dishes ø 12 h 6 cm or 16x16 cm.**  
3 vani per piatti ø 12 h 6 cm o 16x16 cm.





**Insulated box DOMUS**

Box isothermico  
Thermobehälter  
Conteneur isotherme  
Contenedor individual isotérmico

art. cm.  
44976-02 42,5x26,5x16,5

**2 sections for dishes 18x18 cm.**  
2 vani per piatti 18x18 cm.



**Insulated box MONOKING**

Box isothermico  
Thermobehälter  
Conteneur isotherme  
Contenedor individual isotérmico

art. cm.  
44976-01 42,5x35x16

**2 insulated sections for dishes size 18x18 cm.**  
2 vani coibentati per piatti 18x18 cm.



**Insulated box THERMOKING**

Box isothermico  
Thermobehälter  
Conteneur isotherme  
Contenedor individual isotérmico

art. cm.  
44976-03 47x37x18,5

**Release latch lid. Usefull height 11,5 cm.**  
Coperchio a incastro. Altezza utile 11,5 cm.

**MODULAR SYSTEM BASE=LID EXTENSIBLE HEIGHT**  
**SISTEMA MODULARE BASE=COPERCHIO ALTEZZA ESTENSIBILE**



**Modular system, the base and lid are the same element and due to the extender insert it is possible to increase capacity. Equipped with rotation system that allows steam to escape.**

**Sistema modulare, base e coperchio sono lo stesso elemento e grazie all'inserto estensore è possibile aumentare la capacità. Provvisto di sistema rotabile, per la fuoriuscita del vapore.**



**Base and lid**

Base e coperchio  
Basis und Abdeckung  
Base et couvercle  
Base y tapa

art. cm. ext. int.  
44975-35 41x41x7,5 35,2x35,2x4,5  
44975-50 57x57x9,5 51x51x6,3



**Extender**

Estensore  
Aufsatz  
Réhausse  
Extensión

art. cm. ext. int.  
44975H35 41x41x7,5 35,2x35,2x7,5  
44975H50 57x57x9,5 51x51x7,5x9,5





SS

**Insulated container**  
Contentitore isotermico  
Thermobehälter  
Conteneur isotherme  
Contenedor isotérmico

art.	Ø cm.	h. cm.	lt.
44505-10	30	22,5	10
44505-15	36	21,5	15
44505-20	36	28,5	20
44505-25	36	35,0	25



SS

**Insulated container**  
Contentitore isotermico  
Thermobehälter  
Conteneur isotherme  
Contenedor isotérmico

art.	Ø cm.	h. cm.	lt.
44506-09	30	34	9

**Incl. cleaning brush and labels Milk, Coffee and Tea in 5 languages.** – Incl. scovolino, etichette Latte, Caffè e Tè in 5 lingue.



SS

**Food container**  
Pietanziera  
Speisenbehälter  
Porte-manger  
Contenedor comida

art.	Ø cm.	h. cm.
44977-12	12	6



**Insulated container GN 1/1**  
Contentitore isotermico GN 1/1  
Thermobehälter GN 1/1  
Conteneur isotherme GN 1/1  
Contenedor isotérmico GN 1/1

art.	cm.	lt.
44932-15	61x41x25	24,6
44932-20	61x41x30	31,1

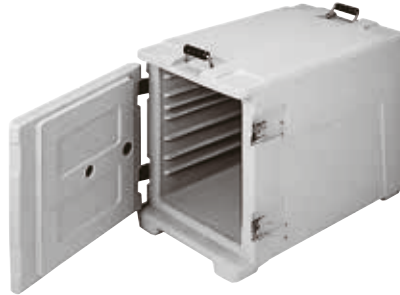

**Insulated container GN 1/1**  
Contentitore isotermico GN 1/1  
Thermobehälter GN 1/1  
Conteneur isotherme GN 1/1  
Contenedor isotérmico GN 1/1

art.	cm.	lt.
44934-30	44x64x48	63



**Insulated beverage dispenser**  
Distributore di bevande isotermico  
Isolierte Getränkebehälter  
Conteneur isotherme avec robinet  
Contenedor isotérmico con grifo

art.	cm.	lt.
44930-10	24x43x43	10
44930-20	30x46x46	20



PP

**Ice cart**  
Carrello porta ghiaccio  
Eiswagen  
Chariot à glace  
Carro hielo

art.	cm.
44936-57	72x57x85

**Load/Carico: 57 kg.**



PC

**Ice scoop with holder**  
Pala ghiaccio con supporto  
Eisschaufel mit Träger  
Pelle à glace avec support  
Librador hielo con soporte

art.	cm.	lt.
44936-02	30,7x20,3x19	2



PC

**Ice bucket**  
Secchio ghiaccio  
Eiseimer  
Seau à glace  
Cubo hielo

art.	cm.	lt.
44936-20	34x31x45	20,8

## JACKSTACK

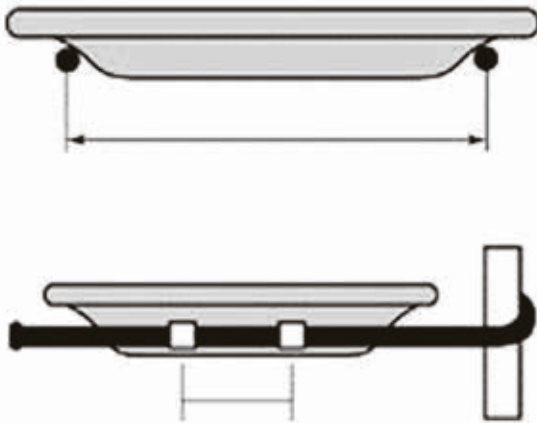

Welded steel construction. Black electrostatic powder coating. Quick set assembly in minutes. Quick-change to any plate size (max ø cm 30, kg 3 each). Length of plate support 17 cm, spacing 5 cm.

Struttura in acciaio saldato. Rivestimento nero elettrostatico. Assemblaggio veloce. Adattabile ad ogni misura di piatto (ø max cm 30, kg 3). Lunghezza bracci 17 cm, distanza 5 cm.



**Mobile plate rack**  
Carrello porta piatti  
Fahrbares Tellergerüst  
Chariot porte-assiettes mobile  
Carrito para almacenaje de platos

art. cm.  
44830-99 60x60X179

For pcs/Per pz 104

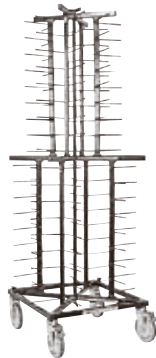

**Mobile plate rack**  
Carrello porta piatti  
Fahrbares Tellergerüst  
Chariot porte-assiettes mobile  
Carrito para almacenaje de platos

art. cm.  
44830-72 60x60X180

For pcs/Per pz 72

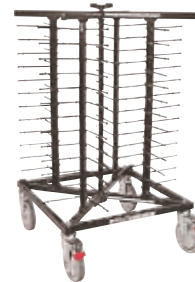

**Mobile plate rack**  
Carrello porta piatti  
Fahrbares Tellergerüst  
Chariot porte-assiettes mobile  
Carrito para almacenaje de platos

art. cm.  
44830-52 60x60x103

For pcs/Per pz 52

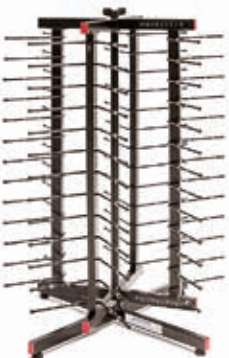

**Swivelling table top rack**  
Porta piatti rotante  
Drehbares Tischgerüst  
Porte-assiettes de table pivotant  
Soporte para almacenaje de platos

art. cm.  
44831-52 48x48x89

For pcs/Per pz 52



**Zippered plastic cover**  
Copertura in plastica  
Plastik Schutzhülle  
Housse en plastique  
Cubrecarrito, plástico

art. for/per  
44832-99 44830-72/44830-99



**Thermo cover**  
Copertura termica  
Thermo-Hülle  
Thermo-housse  
Cubrecarrito, térmico

art. for/per  
44833-99 44830-72/44830-99







**Thermic hot box**

Box termico  
Speisen-Kaste  
Caisson thermique  
Cajón térmico

art.	cm.	W
44094-00	38x40,5x51,2	500

**Stainless steel box with double insulated wall. Analogic thermostat 30-90°C.**  
Box in acciaio inox a doppia parete coibentata. Termostato analogico 30-90°C.



**Refrigerated box**

Box refrigerato  
Speisen-Kaste  
Caisson réfrigéré  
Cajón refrigerado

art.	cm.
44094R00	38x40,5x51

**Stainless steel box with double insulated wall with chilling pack -32°C.**  
Box in acciaio inox a doppia parete coibentata. Refrigerazione a mezzo di una piastra eutettica -32°C.



**Table with hot box**

Tavolino con box termico  
Tisch mit Hot Box  
Table avec hot box  
Carrito con hot box

art.	Ø cm.	h. cm.	W
44094-02	90/54,6	77	500

**Table with fold down flaps. – Tavolo con flaps pieghevoli.**



**Table with hot box**

Tavolino con box termico  
Tisch mit Hot Box  
Table avec hot box  
Carrito con hot box

art.	Ø cm.	h. cm.	W
44094-04	90/54,6	78,6	500

**Table with fold down flaps. With capsizable top for stacking when not in use.**  
Tavolo con flaps pieghevoli. Ribaltabile e impilabile quando non in uso.



**Table with hot box**

Tavolino con box termico  
Tisch mit Hot Box  
Table avec hot box  
Carrito con hot box

art.	Ø cm.	h. cm.	W
44094-06	90/73	76	500

**Table with fold down flaps. Foldable for saving space when not in use. – Tavolo con flaps pieghevoli. Pieghevole per ridurre l'ingombro quando non in uso.**



**Fast food tray**

Vassoio fast food  
Servierplatte, Fast Food  
Plateau fast food  
Bandeja fast food

art.	cm.
41860-36	27x36,5
41860-43	30,7x43,5
41860-47	35,5x47





PP

**Fast food tray**  
Vassoio fast food  
Serviertablett, Fast Food  
Plateau fast food  
Bandeja fast food

art. cm.  
41861-44 30,7x44



PP

**Gastronorm tray**  
Vassoio Gastronorm  
Serviertablett, Gastronorm  
Plateau Gastronorm  
Bandeja Gastronorm

art. cm. col.  
41862B11 53x32,5x1,6 ●  
41862C11 53x32,5x1,6 ●  
41862G11 53x32,5x1,6 ●



PP

**Euronorm tray**  
Vassoio Euronorm  
Serviertablett, Euronorm  
Plateau Euronorm  
Bandeja Euronorm

art. cm. col.  
41862B53 53x37x1,6 ●  
41862C53 53x37x1,6 ●  
41862G53 53x37x1,6 ●



SS

**Universal tray collector trolley**  
Carrello ritiro vassoi universale  
Tablettabräumwagen Universal  
Chariot débarrassage plateaux universel  
Carro porta bandeja universal

art. cm.  
44803-10 47x55x153  
44803-20 88x55x153

**12 cm between shelves. 4 swivel wheels 100 mm. Chrome-plated steel thread supports 6 mm.**  
Distanza fra piani 12 cm. 4 ruote girevoli 100 mm. Supporti in filetto acciaio cromato 6 mm.



SS

**Universal tray collector trolley**  
Carrello ritiro vassoi universale  
Tablettwagen Universal  
Chariot débarrassage plateaux universel  
Carro porta bandeja universal

art. cm.  
44803-30 129x55x153

**They can hold trays in different sizes (width ranging from 300 to 370 mm) including Euronorm and Gastronorm.** – Possono accogliere vassoi di varia misura (larghezza tra 300 e 370 mm) inclusi Euronorm e Gastronorm.



PP

**Disposable covers, 200 pcs**  
Coperture monouso, 200 pezzi  
Einweg-Schutzhüllen, 200 Stk.  
Housses usage unique, 200 pcs  
Cubrecajitos desechables, 200 pz

art. for/per h. cm.  
42512-91 GN 1/1 180  
42512-92 GN 2/1 180  
60x40 180



SS

**Roll holder**  
Porta rotolo  
Rollenhalter  
Dérouleur mural  
Portarollos

art. cm.  
42512-90 90x23x19



SS

**Utility rack GN 2/1**  
Carrello GN 2/1  
2/1 GN-Behälterwagen  
Chariot GN 2/1  
Carro GN 2/1

art. cm.  
44807-28 60x70x153,5

**Welded structure, 28 rails, 4 wheels, 2 with brakes.** – Struttura saldata, 28 guide, 4 ruote girevoli di cui 2 con freno.



SS

**Utility rack GN 2/1**  
Carrello GN 2/1  
2/1 GN-Behälterwagen  
Chariot GN 2/1  
Carro GN 2/1

art. cm.  
44807-36 73x62x171

**To be assembled, 18 rails, accomodates GN pans height 65 mm. Load max 300 kg.**  
Fornito smontato, 18 guide, accoglie GN di h. 65 mm. Carico max 300 kg.





SS

**Utility rack GN 1/1**

Carrello GN 1/1  
1/1 GN-Behälterwagen  
Chariot GN 1/1  
Carro GN 1/1

art. cm.  
44807-18 38x62x164

**To be assembled, 18 rails, accomodates GN pans height 65 mm. Load max 150 kg.**

Fornito smontato, 18 guide, accoglie GN di h. 65 mm. Carico max 150 kg.



SS

**Utility rack GN 1/1**

Carrello GN 1/1  
1/1 GN-Behälterwagen  
Chariot GN 1/1  
Carro GN 1/1

art. cm.  
44801-09 38x62x94,5

**To be assembled, 9 rails, accomodates GN pans height 65 mm. Load max 75 kg.**

Fornito smontato, 9 guide, accoglie GN di h. 65 mm. Carico max 75 kg.



SS

**Baking sheet trolley**

Carrello porta teglie  
Backbleche-Wagen  
Chariot pour plaques  
Carro porta placas

art. cm.  
44826-00 52x72x85

**Pitch 7,5 cm. For 60x40 cm trays. S/steel top. Swivel castors ø 9.5 cm, 2 with brakes. – Passo 7,5 cm. Per teglie cm 60x40. Piano superiore inox. Ruote piroettanti ø cm 9,5 di cui 2 con freno.**



SS

**Serving trolley**

Carrello di servizio  
Mehrzweckwagen  
Chariot de service  
Carrito para desocupar

art. cm.  
44819-02 91x59x93

**To be assembled, 4 swivel castors, 2 with brakes. Load max 80 kg. – Fornito smontato, 4 ruote girevoli di cui 2 con freno. Carico max 80 kg.**



SS

**Serving trolley**

Carrello di servizio  
Mehrzweckwagen  
Chariot de service  
Carrito para desocupar

art. cm.  
44819-03 91x59x93

**To be assembled, 4 swivel castors, 2 with brakes. Load max 120 kg. – Fornito smontato, 4 ruote girevoli di cui 2 con freno. Carico max 120 kg.**



SS

**Serving trolley**

Carrello di servizio  
Mehrzweckwagen  
Chariot de service  
Carrito para desocupar

art. cm.  
44820-80 80x50x93,5  
44820-99 100x50x93,5

**To be assembled, 4 swivel castors, 2 with brakes. Max load per shelf kg 30.**  
Fornito smontato, 4 ruote girevoli di cui 2 con freno. Portata max. per ripiano kg 30.



SS

**Serving trolley**

Carrello di servizio  
Mehrzweckwagen  
Chariot de service  
Carrito para desocupar

art. cm.  
44822-80 80x50x93,5  
44822-99 100x50x93,5

**To be assembled, 4 swivel castors, 2 with brakes. Max load per shelf kg 30.**  
Fornito smontato, 4 ruote girevoli di cui 2 con freno. Portata max. per ripiano kg 30.



PP

**Serving trolley**

Carrello di servizio  
Mehrzweckwagen  
Chariot de service  
Carrito para desocupar

art. cm.  
44030-03 42x71x90



PP

**Bins and containers**

Cesti e contenitori  
Kasten und Körbe  
Réipients et containers  
Cubos y contenedores

art. cm.  
44031-04 52x39x12,7  
44031-05 52x39x17,7



PE

**Container**  
 Contenitore  
 Kaste  
 Réciptent  
 Contenedor

art. cm.  
 44031-01 33,7x23x56  
 44031-02 33,7x23x18,7



PP

**Serving trolley**  
 Carrello di servizio  
 Mehrzweckwagen  
 Chariot de service  
 Carrito para desocupar

art. cm.  
 49995-04 97x51x99

**Load max 135 kg (45 kg per shelf).**  
 Carico max 135 kg (45 kg per ripiano).



SS

**Minibar restocking cart**  
 Carrello rifornimento frigobar  
 Wagen für Minibar-Versorgung  
 Chariot mini-bar  
 Carro servicio minibar

art. cm.  
 44095-30 73x47x102

**3 PVC boxes with anti-tip cage for 40 bottles  
 ø 6,5 cm max. Castor wheels ø 12,5 cm, 2 with  
 brakes.** – Con 3 cassette in PVC, dotate di gabbia  
 antiribaltamento per 40 bottiglie ø cm 6,5 max.  
 Ruote piroettanti ø cm 12,5 di cui 2 con freno.



**Minibar restocking cart**  
 Carrello rifornimento frigobar  
 Wagen für Minibar-Versorgung  
 Chariot mini-bar  
 Carro servicio minibar

art. cm.  
 44095-32 100x62x119

**Side handle. Key lock. 2 fixed and 2 swivel  
 casters ø 16 cm 2 with brakes.** – Maniglia laterale  
 di spinta. Chiusura con chiave. Ruote ø cm 16, di cui  
 due fisse e due piroettanti con freno.



SS

**Utility rack GN 2/1**  
 Carrello GN 2/1  
 2/1 GN-Behälterwagen  
 Chariot GN 2/1  
 Carro GN 2/1

art. cm.  
 44801-18 73x62x94,5

**To be assembled, 9 rails, accomodates GN pans  
 height 65 mm. Load max 150 kg.**  
 Fornito smontato, 9 guide, accoglie GN di h. 65  
 mm. Carico max 150 kg.



SS

**Baking sheet trolley**  
 Carrello porta teglie  
 Backbleche-Wagen  
 Chariot pour plaques  
 Carro porta placas

art. cm.  
 44826-20 69x49x187

**20 rails for baking sheets cm 60x40, height  
 clearance 8 cm. Load max 100 kg.**  
 20 guide per teglie cm 60x40, distanza guide 8  
 cm. Carico max 100 kg.



**Baking sheet trolley, galvanized steel**  
 Carrello porta teglie, zincato  
 Backbleche-Wagen, verzinkt  
 Chariot pour plaques, galvanisé  
 Carro porta placas, galvanizado

art. cm.  
 44825-20 51x50x170

**20 rails, height clearance 8 cm. Load max. 80 kg.**  
 20 guide, distanza guide 8 cm. Carico max 80 kg.

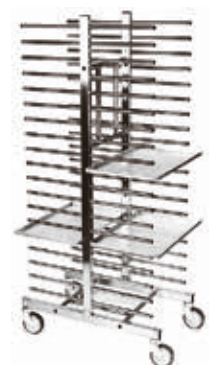

**Baking sheet trolley, galvanized steel**  
 Carrello porta teglie, zincato  
 Backbleche-Wagen, verzinkt  
 Chariot pour plaques, galvanisé  
 Carro porta placas, galvanizado

art. cm.  
 44825-40 51x75x170

**40 rails, height clearance 8 cm. Load max 160  
 kg.** – 40 guide, distanza guide 8 cm. Carico  
 max 160 kg.





**SS**

**Dolly for cases**

Carrello porta cassette  
Plattformwagen  
Chariot à caisses  
Carretilla de transporte

art. cm.  
44026-60 65x45x12

**Load max 50 kg. – Carico max 50 kg.**



**PE**

**Platform cart**

Carrello trasporto materiali  
Plattformwagen  
Chariot de transport  
Plataforma móvil

art. cm.  
49378-00 82,6x52x98,7

**Three position handle ensures optimum handling whatever the load. Non slip deck, 2 swivel and 2 rigid castors. Load 181 kg. – Maniglia regolabile in 3 posizioni. Superficie antiscivolo. 2 ruote fisse, 2 pivotanti. Carico 181 kg.**



**PP**

**Trolley, convertible**

Carrello convertibile  
Plattformwagen, umwandelbar  
Chariot convertible  
Carretilla convertible

art. cm.  
49379-00 56x53x43,5

**Four non-marking casters (two rear locking), 2 swivel and 2 rigid. – Ruote antitraccia di cui 2 fisse e 2 girevoli, ruote posteriori bloccabili.**





# CLEANING & SAFETY

## PULIZIA & SICUREZZA





PP

**Changing table**

Fasciatoio da parete  
Windeln-Tisch  
Table à langer  
Mesa cambia-pañales

art.	cm.
49336-00	91x71x49,6
49336-02	60x88x48

Rated for continuous use up to 23 kg. – Portata max in uso 23 kg.



PP

**Sturdy chair**

Seggiolone  
Kinderstuhl  
Chaise d'enfant  
Silla niños

art.	cm.
49337-00	60x60x75,5
49337-01	29x47x8,3

For children up to 3 years old or 18 kg weight. With Microban antimicrobial protection. – Adatto a bambini fino a 3 anni o 18 kg di peso. Con protezione antibatterica in Microban.



W

**Sturdy chair**

Seggiolone  
Kinderstuhl  
Chaise d'enfant  
Silla niños

art.	cm.	col.
49335-01	50x50x75	●
49335-02	50x50x75	●

Suitable for children from 6 months to 3 years. Max 20 kg. Solid and sturdy, built with rubber tree wood, respecting the environment. Wide base for greater stability. Easy to assemble. Stackable to save space. Supplied with seat belts and safety buckle. – Adatto ai bambini da 6 mesi a 3 anni. Fino a 20 kg. Solido e robusto, costruito con legno di albero della gomma, in rispetto dell'ambiente. Base larga per una maggiore stabilità. Facile da montare. Impilabile per risparmiare spazio. Fornito con cinture e fibbia di sicurezza.



**Trolley Quick Cart**

Carrello Quick Cart  
Quick Cart-Wagen  
Chariot Quick Cart  
Carretilla Quick Cart

art.	cm.	Kg.	cap. m3
44178-01	42x36x43	6,5	0,05
44178-02	42x36x53	7,0	0,06

Versatile compartments allow for multiple configurations and uses. Removable caddy. Adjustable dividers. Teflon fabric protector, repels water, oil and stains. Reinforced rubberised kick plate. – Scomparti versatili consentono molteplici configurazioni e usi. Cestello estraibile. Divisori removibili. Rivestimento in Teflon, respinge acqua, olio e macchie. Scocca rinforzata in gomma.



**Collapsible frame, powder coated steel**

Telaio pieghevole, acciaio verniciato  
Klappbares Gestell, pulverbeschichtete Stahl  
Châssis repliable, acier peint  
Carre plegable, acero pintado

art.	cm.	lt.
44178-15	51,5x61x84	150
44178-16	89x61x84	300

Collapsible frame enables efficient storage. Compact, lightweight design for superior manoeuvrability. Remains collapsible with or without cover. – Telaio pieghevole consente uno stoccaggio efficiente. Design compatto e leggero per una maggiore manovrabilità. Rimane pieghevole con o senza copertura.



**Vinyl bag, black**

Sacco vinile, nero  
Vinyl-Sack, schwarz  
Sac en vinyle, noir  
Bolsa de vinilo, negro

art.	cm.	lt.
44178-17	39x57x69	150
44178-18	78x57x69	300

**Durable, high capacity (100 kg) vinyl bag accommodates large loads; easy-to-clean.** – Sacchi in vinile durevoli, ad alta capacità (100 kg); facili da pulire.



**Vinyl bag cover, black**

Copertura vinile, nero  
Vinyl-Sack-deckel, schwarz  
Couvercle à sac en vinyle, noir  
Tapa para bolsa de vinilo, negro

art.	cm.
44178-19	64x50x23
44178-20	89x66x23

**Multiple, built-in storage pockets on each side. Convenient, Quick-Access-Lid provides easy access to contents inside of cart without having to remove cover.** – Con tasche integrate su ogni lato. Comodo, accesso rapido all'interno del carrello, senza dover rimuovere il coperchio.



PP

**Service trolley**

Carrello di servizio  
Servicewagen  
Chariot de service  
Carro de habitaciones

art.	cm.	lt.	Kg.
44174-24	177x58x107	120+120	26,4

**Wheels ø 125 mm, 2 bag holders + 2 bags lt 120. Made in PP copolymer.**  
Ruote ø 125 mm, 2 portasacchi pieghevoli + 2 sacchi lt 120. Prodotto in PP copolimero.



PP

**Service trolley**

Carrello di servizio  
Servicewagen  
Chariot de service  
Carro de habitaciones

art.	cm.	lt.	Kg.
44177-12	104x56x130	150	26

**Frame in tubular steel rilsan coated. Wheels ø 125 mm. 3 wooden shelves 50x46 cm. Bag holder + canvas bag polyester 55x55x94 cm.**  
Montanti in tubolare inox verniciato rilsan. Ruote ø 125 mm. 3 ripiani legno 50x46 cm. Portasacchi+sacchi in tela poliestere 55x55x94 cm.



PP

**Housekeeping cart for linen collection**

Carrello portabiancheria  
Hotelwäschewagen  
Chariot d'étage à linge  
Carro de recogida de ropa

art.	cm.	lt.	Kg.
44176-30	105x55x105	300	12,5

**Frame in tubular steel rilsan coated. Wheels ø 125 mm. Nylon bag.** – Montanti in tubolare inox verniciato rilsan. Ruote ø 125 mm. Sacco in nylon plastificato.



**Housekeeping cart for linen collection**

Carrello portabiancheria  
Hotelwäschewagen  
Chariot d'étage à linge  
Carro de recogida de ropa

art.	cm.	lt.	Kg.
44175-15	62x60x103	150	6,39

**Capacious canvas bag laminated washable at 30°C. Folding frame. Swivel casters ø 80 mm.** – Capiente sacco in tela plastificata lavabile a 30°C. Telaio pieghevole. Ruote piroettanti ø 80 mm.







**Cleaning system, Pulse**

Sistema di pulizia, kit Pulse  
Reinigungssystem Pulse  
Système de nettoyage Pulse  
Sistema de limpieza Pulse

art. cm.  
44151-00 12,4x9,5x142

**Aluminum frame 40 cm and 2 microfibre mops. On-board reservoir 700 ml that allows to clean up to 80 sqm.**

Telaio in alluminio con velcro da 40 cm, 2 mop in microfibra. Dotato di deposito integrato da 700 ml che permette di pulire fino a 80 mq.



**Microfibre mops**

Mop in microfibra  
Microfibr-Mops  
Franges en microfibre  
Fregadoras de microfibra

art.	cm.	des.	U. Pack
44151-AA	40x14	Wet	10
44151-AB	40x14	High absorb	10
44151-AC	40x14	Scrubber	10

**Wet use, high absorbency, for 80 sqm. Launderable up to 500 times (200 with bleach) at high water temperature. – Uso umido ad elevata assorbenza 80 mq. Ciclo di vita: 500 lavaggi (200 con candeggina) ad elevate temperature.**



**Dust beater V sweeper**

Scopa a forbice  
Doppel-Wischmop  
Balai double mop  
Escoba doble

art. h. cm.  
44160-03 135

**Opening angle 140° about. Cotton mops length 100 cm. – Apertura 140° circa. Frange in cotone 100 cm.**



**Mechanical sweeper**

Aspirapolvere meccanico  
Kehrer mit mechanischem Antrieb  
Balai mécanique  
Escoba mecánica

art. cm. lt.  
44150-19 28,5x25x102 0,6

**ABS and galvanised steel construction. Ideal for hard floors and low pile carpets. Sweeping path 19 cm. – ABS e acciaio galvanizzato. Ideale sia per tappeti/moquette a pelo corto che per pavimenti. Battuta 19 cm.**



**Broom + dust pan**

Scopa + alza immondizia  
Kehrset mit Stiel und Schmutzcontainer  
Balai + pelle  
Escoba + recogedor

art. cm.  
44149-03 28,6x13x32,5

**Self opening and closing lid. Broom hanger bracket. – Porta immondizia con coperchio. Staffa di supporto per scopa.**



**Dustpan**

Pattumiera  
Müllschaufel  
Pelle à poussière  
Pala

art. cm.  
44170-00 29x28x87,5

**Shock-proof plastic material, equipped with a rubber blade that adheres perfectly to the floor. Aluminium handle. – Materiale plastico antiurto, dotata di una lamina di rifinitura in gomma che aderisce perfettamente al pavimento.**



**Broom, aluminum rod**

Scopa, manico alluminio  
Besen mit Alustiel  
Balai, manche alu  
Escoba, mango alumínio

art. h. cm.  
44170-01 80

**To use in combination with the handy dustpan thanks to its ergonomic grip with handle holder. Da utilizzarsi abbinata alla pattumiera, a cui può essere agganciata tramite l'attacco portamanico.**



**Cleaning wand**

Scopa spingiacqua  
Abzieher  
Balai raclette  
Jalador de agua

art. cm.  
44148-01 116,8x40

**Blade made of soft double mass squeegee foam supported by a galvanized metal frame. Testa della scopa realizzata in morbida gommaspugna a doppio strato sostenuta da telaio in metallo galvanizzato.**



**Wet mop handles**

Manico per mop  
Nassmopp-Stiele  
Supports pour franges  
Mangos para fregonas

art.	cm.	col.
44141-01	152,4	●
44141-03	152,4	●

**Polypropylene/Glass fiber. Polipropilene/fibra di vetro.**





**Cotton-end string mop**

Mop a strisce in cotone  
Spaghetti-Mop mit Baumwollenend  
Frange à ficelles en coton  
Mopa de algodón

art.	gr.
44142-40	400



**Cotton mop rod, screw fitting**

Manico per mop, attacco filettato  
Mop-Stange mit Schraubanschluss  
Manche pour mop avec attache à vis  
Mango para fregadora, conexión tornillo

art.	Ø cm.	cm.
44167-13	2,2	130

**Red lacquered iron. Lightweight and rustproof.**  
Ferro verniciato rosso. Leggero ed inossidabile.



**Cotton mop, screw fitting**

Mop in cotone, attacco filettato  
Baumwollmop mit Schraubanschluss  
Mop en coton avec attache à vis  
Mopa de algodón

art.	gr.
44166-28	280



**Telescopic rod**

Manico telescopico  
Teleskopstange  
Manche telescopique  
Mango telescópico

art.	Ø cm.	cm.
44161-00	2,3	97>184

**Two-piece anodized aluminum rod.**  
Alluminio anodizzato due pezzi.



**Mop holder**

Pinza per mop  
Wischmophalter  
Pince faubert  
Pinza

art.
44164-00

**Universal ring allows the use of any handle with from ø 20 to 24 mm. – Ghiera universale consente l'utilizzo di qualsiasi manico con ø 20>24 mm.**



**Cotton-end string mop**

Mop a strisce in cotone  
Spaghetti-Mop mit Baumwollenend  
Frange à ficelles en coton  
Mopa de algodón

art.	gr.
44165-35	350
44165-40	400
44165-50	500



**Microfibre cloth, 12 pcs**

Panno in microfibra, 12 pz  
Mikrofasertuch, 12 Stk  
Carré en microfibre, 12 pcs  
Paño de microfibra, 12 pz

art.	cm.	col.
44147-00	40,6x40,6	●
44147-01	40,6x40,6	●
44147-02	40,6x40,6	●
44147-03	40,6x40,6	●

**Launderable up to 100 times with bleach and 250 without bleach. – Dura 100 lavaggi con candeggina e 250 senza.**



**Floor sign, 2-sided**

Cavalletto segnalazione a 2 lati  
Warnschild, 2-seitig  
Panneau d'avertissement 2 côtés  
Señal de suelo 2 lados

art.	h. cm.
44077-00	57
44077-CC	67

PP



**Safety chain for floor signs**

Catenella di sicurezza per cavalletti  
Kunststoff-Kette für Warnschilder  
Chaîne de sécurité pour panneaux de sol  
Cadena plástica para señales de suelo

art.	cm.
44077-06	600

**To link floor signs or safety cones together to create an effective barrier system for hazardous areas. – Per collegare cavalletti e coni di segnalazione e creare un sistema di delimitazione delle aree pericolose.**





**Telescopic door sign**

Segnalatore telescopico di sicurezza  
Teleskop-Sicherheitstürschild  
Panneau de sécurité télescopique  
Señal de seguridad telescópico

art. cm.  
44077-10 63,5x2,5x33

**Aluminium/Vinyl. Width open 112 cm. Extendable pole to block out doorways and entrances.**  
Alluminio/Vinile. Larghezza aperto 112 cm. Palo estensibile per bloccare porte e ingressi.



**Multi-purpose trolley**

Carrello multiuso  
Allzweckwagen  
Chariot multi-usage  
Carro de limpieza

art. cm.  
44173-00 97x68x111

**Bag holder with cover, bag lt. 120, pan with hooks, 2 buckets 4 lt. and 2 buckets 15 lt., wringer.** – Portasacco con cop., sacco lt. 120, vaschetta con ganci, 2 secchi 4 lt., 2 secchi 15 lt., strizzatore.



**Mopping trolley with press**

Carrello lavapavimenti con strizzatore  
Wringer Reinigungswagen mit Presse  
Chariot de ménage avec presse  
Carro con prensa escurridora

art. cm.  
44171-24 62x42x90

**Wringer and 25 lt. bucket. With storage compartment. PSV reinforced handle.**  
Strizzatore e 1 secchio lt. 25. Vano portaoggetti. Impugnatura in PSV completa di rinforzi.



**Mopping trolley with press**

Carrello lavapavimenti con strizzatore  
Wringer Reinigungswagen mit Presse  
Chariot de ménage avec presse  
Carro con prensa escurridora

art. cm.  
44171-50 69x42x90

**Wringer and 2 buckets lt. 25 each. Painted handle, reversible.** – Strizzatore e 2 secchi da lt. 25. Impugnatura verniciata, reversibile.



**Mopping trolley with press**

Carrello lavapavimenti con strizzatore  
Wringer Reinigungswagen mit Presse  
Chariot de ménage avec presse  
Carro con prensa escurridora

art. cm.  
44172-30 47x40x93

**Single tank with wringer.**  
Monovasca con strizzatore.



**Graduated bucket**

Secchio graduato  
Eimer mit Skala  
Seau gradué  
Cubo con medidas

art.	cm.	lt.	col.
44169B06	24x19x21,5	6	●
44169R06	24x19x21,5	6	●



**Graduated bucket**

Secchio graduato  
Eimer mit Skala  
Seau gradué  
Cubo con medidas

art.	cm.	lt.	col.
44169B14	34x33,5x28	15	●
44169R25	37x36,5x32	25	●



**Bucket with wringer**

Secchio con strizzatore  
Eimer mit Presse  
Seau avec essoreur  
Cubo con prensa

art. cm. lt.  
44168-12 35x27x29,5 12

**With graduated scale 0-12 lt.**  
Scala graduata 0-12 lt.



**Waste container**

Cestino  
Abfallbehälter  
Collecteur  
Papelera

art. Ø cm. h. cm. lt.  
44097-00 30 31,5 15,9



**Waste container SLIM JIM**

Contentore rifiuti  
Abfallbehälter  
Collecteur  
Colector

art.	cm.	lt.
49931-60	59x28X63	60
49931-87	56x28X76	87



**Hinged lid**

Coperchio ancorato  
Klapp-Deckel  
Couvercle à charnière  
Tapa abatible

art.	cm.
49931-00	55,6x34x3



**Lid**

Coperchio  
Deckel  
Couvercle  
Tapa

art.	cm.	col.
49931A00	52x29x7	●
49931C04	52x29x7	●
49931B05	52x29x7	●
49931B02	52x29x7	●
49931B03	52x29x7	●
49931B01	52x29x7	●



**Dolly SLIM JIM**

Carrello  
Transportwagen  
Chariot  
Carrito

art.	cm.
49931-64	60,6x37,4X21

**Side clip allows to tow together more trolleysdal release fast and simple. –** Aggancio laterale a clip che permette di trainare insieme diversi carrelli. Rilascio a pedale semplice e veloce.





**PE**

**Step on bin**

Pattumiera a pedale  
Pedaleimer  
Poubelle à pédale  
Colector a pedal

art.	cm.	lt.
49933-30	50x31x56,5	30
49933-50	53x34x72	50
49933-68	56x37x78	68



**PE**

**Mobile pedal bin**

Pattumiera a pedale  
Pedaleimer  
Poubelle à pédale  
Colector a pedal

art.	cm.	lt.
44095-12	48x55x93	120

**Certified UNI EN 840. Withstanding chemical, can be washed and sterilized.** – Certificata UNI EN 840. Resistente agli agenti chimici, lavabile e sterilizzabile.



**PP**

**Mobile pedal bin**

Pattumiera a pedale  
Pedaleimer  
Poubelle à pédale  
Colector a pedal

art.	cm.	lt.
44095-18	40x65x81	80



**PP**

**Mobile pedal bin**

Pattumiera a pedale  
Pedaleimer  
Poubelle à pédale  
Colector a pedal

art.	cm.	lt.	col.
44096-80	48x50x78	80	○
44096B80	48x50x78	80	●
44096Y80	48x50x78	80	●
44096R80	48x50x78	80	●
44096G80	48x50x78	80	●



**Refuse bag holder trolley**

Carrello portasacco  
Sackhalterwagen  
Chariot porte-sac  
Colector móvil

art.	cm.	lt.
44089-12	58x56x102	120

**Coated iron foldable frame. Round bag holder, pirouetting wheels Ø 80 mm.** – Telaio pieghevole in acciaio verniciato. Portasacco rotondo. Ruote piroettanti Ø 80 mm.



**PP**

**Mobile pedal bin, fire-proof**

Pattumiera a pedale, ignifuga  
Pedaleimer, feuersicher  
Poubelle à pédale, ignifugée  
Colector a pedal, ignífugo

art.	cm.	lt.	col.
49899-01	46x32x80	70	●

**Mechanical parts in stainless steel. The lid can be removed.** – Parti meccaniche in acciaio inox. Coperchio staccabile.



**PP**

**Pedal bin lids**

Coperchi pattumiera  
Pedaleimer-Deckel  
Couvercles poubelle  
Tapas para colector

art.	cm.	col.
49899-91	46x32	●
49899-92	46x32	●
49899-93	46x32	●
49899-94	46x32	●
49899-95	46x32	●



**PE**

**Tilt truck**

Benna ribaltabile  
Fallen Eimerwagen  
Benne  
Carrito plegable

art.	cm.	lt.	Kg.
49934-04	145x68x86	400	205
49934-06	164x77x97	600	272
49934-08	180x85x107	800	570





PE

**Domed linged lid**

Coperchio a doppia apertura  
Doppel-Deckel  
Couvercle double  
Tapa doble

art.	cm.
49934-14	132x71x23
49934-16	155x81x23
49934-18	169x87x23



PP

**Folding ladder**

Scaletta pieghevole  
Klappleiter  
Marche-pied pliable  
Escalera plegable

art.	cm.
49378-48	48,6x17x63

**Load 150 kg. Resists from 0 to 50 °C.**  
Carico 150 kg. Resiste da 0 a 50°C.



PE

**Pallet**

Pallet  
Pallet  
Palette  
Racks para suelos

art.	cm.	Kg.
49373-05	80x120x14	4,6

**Static load 1000 kg. Appropriate for food.**  
Carico statico 1000 kg. Per uso alimentare.



**Dunnage rack**

Pedana  
Lageruntersätze  
Palettes  
Bancada

art.	cm.	load kg
49371-09	91,4x56x30,5	68
49371-12	122x56x30,5	136

**Rust and corrosion-proof polymer material.**  
Materiale polimerico resistente alla ruggine e alla corrosione.



SS

**Floor standing ashtray**

Posacenere a colonna  
Standascher/Abfalleimer  
Cendrier sur pied  
Contenedor con cenicero

art.	Ø cm.	h. cm.
49897-09	9	86



SS

**Standing ashtray/bin**

Posacenere/pattumiera  
Standascher/Abfalleimer  
Cendrier/poubelle  
Cenicero/papelera

art.	Ø cm.	h. cm.
49898-30	30	60



PP

**Standing ashtray**

Posacenere/fioriera  
Standascher  
Cendrier sur pied  
Cenicero

art.	Ø cm.	h. cm.
49892-40	40	60

**Included bag of sand 1,5 kg.**  
Incl. sacchetto sabbia kg 1,5.

## RETRACTABLE BARRIERS ASTE DELIMITA CORSIE

Tubular structure in stainless steel matte finish or black lacquered  $\varnothing$  63 mm, thickness 0,8 mm. 4-way retractable polyester black belt length 2,13 meters, width 4,8 cm. Ballasted base  $\varnothing$  cm 31 with rubber under the base. Weight 10 kg. Overall height 1 mt. Possibility to apply landscape display.

Struttura tubolare in acciaio inossidabile finitura satinata o laccata nera  $\varnothing$  63 mm, spessore 0,8 mm. Nastro retrattile 4-vie in poliestere nero lunghezza 2,13 metri, larghezza 4,8 cm. Base zavorrata  $\varnothing$  31 cm con gomma sotto la base. Peso 10 kg. Altezza totale 1 mt. Possibilità di applicare tabella segnaletica.



### Retractable barrier set

Set aste delimita corsie a nastro estensibile  
Absperrpfost mit einziehbarer Gurt, 2 Stk  
Set poteaux avec ceinture rétractable  
Juego de columnas móviles con cinta retráctil

art.	$\varnothing$ cm.	base $\varnothing$ cm.	belt/nastro	h. cm.	Kg.
44183-01	6,3	36	cm 213x4,8	100	10

**Black laquered.** – Laccato nero.



### Retractable barrier set

Set aste delimita corsie a nastro estensibile  
Absperrpfost mit einziehbarer Gurt, 2 Stk  
Set poteaux avec ceinture rétractable  
Juego de columnas móviles con cinta retráctil

art.	$\varnothing$ cm.	base $\varnothing$ cm.	belt/nastro	h. cm.	Kg.
44184-01	6,3	36	cm 213x4,8	100	10

**Stainless steel matt finish.** – Inox finitura satinata.



### Post top sign holder

Tabella  
Posterhalter  
Porte-enseigne  
Cartelera

art.	cm.
44183-A4	DIN-A4
44183-A3	DIN-A3

**Black laquered.** – Laccato nero.



### Post top sign holder

Tabella  
Posterhalter  
Porte-enseigne  
Cartelera

art.	cm.
44184-A4	DIN-A4
44184-A3	DIN-A3

**Stainless steel matt finish.** – Inox finitura satinata.



# ELECTRIC APPLIANCES APPARECCHI ELETTRICI







**Dualit.**

**4 slot toaster**

Tostapane 4 fette  
Brotröster  
Grille pain  
Tostadora

art.	cm.	Kg.	kW
49801-04	36x21x22	4,25	2,2



**Dualit.**

**6 slot toaster**

Tostapane 6 fette  
Brotröster  
Grille pain  
Tostadora

art.	cm.	Kg.	kW
49801-06	46x21x22	5,1	3



**Dualit.**

**4 slice bun toaster**

Tostapane 4 fette  
Brotröster  
Grille pain  
Tostadora

art.	cm.	Kg.	kW
49802-04	36x21x22	4,52	1



**Dualit.**

**6 slice bun toaster**

Tostapane 6 fette  
Brotröster  
Grille pain  
Tostadora

art.	cm.	Kg.	kW
49802-06	46x21x22	5,52	1,5



**Conveyor Toaster**

Tostapane a nastro  
Durchlauf-Toaster  
Toaster convoyeur  
Tostador a túnel

art.	cm.	Kg.	kW
49803-02	37x64x40	20	2,8



**Conveyor toaster, CT540 B**

Tostapane a nastro doppia uscita  
Durchlauf toaster  
Toaster convoyeur  
Tostador a túnel

art.	cm.	Kg.	kW
49850-20	50x68x34,5	20	2,65



**Toaster, BAR 1000**

Tostapane  
Toast-/Überbackgerät  
Toaster  
Tostador de pan

art.	cm.	Kg.	kW
49850-65	45x28,5x30,5	10	2



**Contact grill, SAVOYE**

Grill a contatto  
Kontaktgrill  
Grill à contact  
Grill de contacto

art.	cm.	Kg.	kW
49850-22	33x38,5x22	18	2





**Contact grill, PANINI**

Grill a contatto  
Kontaktgrill  
Grill à contact  
Grill de contacto

art.	cm.	Kg.	kW
49850-21	43x38,5x22	22,5	3



**Contact grill double plate, MAJESTIC**

Grill a contatto doppia piastra  
Kontaktgrill, 2 Platten  
Grill à contact, 2 plaques  
Grill de contacto doble

art.	cm.	Kg.	kW
49850-23	60x38,5x22	33,5	2x2



**Dualit.**

**Contact sandwich toaster**

Grill a contatto  
Sandwich-Toaster  
Appareil croque monsieur  
Grill de contacto

art.	cm.	Kg.	kW
49806-00	40x22x19	6	1,6



**Contact grill, PANINI XL**

Grill a contatto  
Kontaktgrill  
Grill à contact  
Grill de contacto

art.	cm.	Kg.	kW
49850-19	41x62x34	32	3,6



**Glas ceramic contact grill, GVS 335**

Grill a contatto vetroceramica  
Kontaktgrill, Glaskeramik-Platte  
Grill à contact vitrocéramique  
Grill de contacto vitrocerámica

art.	cm.	Kg.	kW
49850-18	39x60x26	14	3



**Salamander, SEM 600 PDS**

Salamandra  
Salamandrs mit PDS  
Salamandre avec détection de plat  
Salamandra con PDS

art.	cm.	Kg.	kW
49850-71	60x64x59	56	3





**Hot dog heater, CS 3 E**

Scalda würstel  
Würstchenwärmer  
Chauffe-saucisses  
Calentador de salchichas

art.	cm.	Kg.	kW
49850-61	44x30x40	9	0,65



**Kebab/Gyros grill, GR 40 E**

Griglia kebab/gyros  
Elektro-Dönergrill  
Gril à kebab/gyros  
Asador de kebab/gyros

art.	cm.	Kg.	kW
49850-13	58x66x69,5	15	3,6

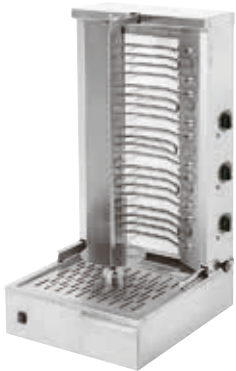

**Kebab/Gyros grill, GR 60 E**

Griglia kebab/gyros  
Elektro-Dönergrill  
Gril à kebab/gyros  
Asador de kebab/gyros

art.	cm.	Kg.	kW
49850-14	58x66x87	25	5,8

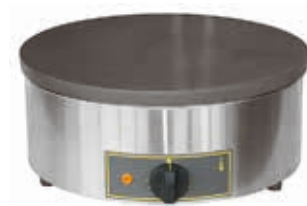

**Crepe machine, high-capacity, CFE 400**

Crepiera tonda, ad alto rendimento  
Crêpegerät  
Crêpière à haut rendement  
Crepera

art.	Ø cm.	h. cm.	Kg.	kW
49850-33	40	20	18	3,6

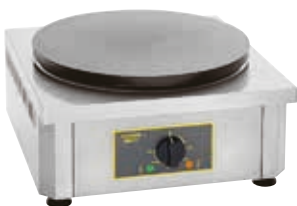

**Double crepe machine, CDE 400**

Crepiera doppia  
Crêpegerät, 2 Platten  
Crêpière double  
Crepera 2 placas

art.	Ø cm.	cm.	Kg.	kW
49850-11	40	45x50x24	23	3,6



**Eggs boiler, CO 60**

Bollitore uova  
Eierkocher  
Cuiseur à oeuf  
Caldera para huevos

art.	cm.	Kg.	kW
49850-36	21,5x43x25,5	4,5	1,2





**Multifunction oven, FC 280**

Forno multifunzione  
Multifunktionsofen  
Four multifonctions  
Horno multifunción

art.	cm.	Kg.	kW
49850-73	46x55x35,5	20	1,5



**Multifunction oven, FC 380 TQ**

Forno multifunzione  
Multifunktionsofen  
Four multifonctions  
Horno multifunción

art.	cm.	Kg.	kW
49850-75	55x55x35,5	22	2,4



**Multifunction oven, FC 60 TQ**

Forno multifunzione  
Multifunktionsofen  
Four multifonctions  
Horno multifunción

art.	cm.	Kg.	kW
49850-76	59,5x61x59	38	3



**Fryer, FD 80 R**

Friggitrice  
Fritteuse  
Friteuse  
Freidora

art.	cm.	kg./H	Kg.	kW
49850-41	26,5x45x36	15	8	3,6



**Fryer, FD 80 DR**

Friggitrice  
Fritteuse  
Friteuse  
Freidora

art.	cm.	kg./H	Kg.	kW
49850-42	59x45x37	30	15	2x3,6



**Fryer, FD 50**

Friggitrice  
Fritteuse  
Friteuse  
Freidora

art.	cm.	kg./H	Kg.	kW
49850-37	21,5x42,5x32	10	5	3,2





**Dish-warmer, DW106 / 110**

Scaldapiatti  
Rechaud  
Chauffe plats  
Calentador de platos

art.	cm.	Kg.	kW
49850-06	40x21,5x33,5	14	0,65
49850-10	40x21,5x47,5	25	1,3



**Ventilated warming display, WD 780 DI**

Espositore caldo ventilato  
Konvektion-Warme Theke  
Présentoir chaud à convection  
Expositor caliente con convección

art.	cm.	Kg.	kW
49850-70	78x49x64	35	1,8

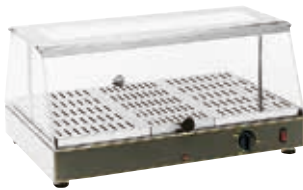

**Warming display**

Vetrina riscaldata  
Warmhalte-Vitrine  
Vitrine chauffante  
Vitrina caliente

art.	GN	cm.	Kg.	kW	range
49850-43	1/1	59x35x28,5	12	0,65	+20 +95°C



**Warming display**

Vetrina riscaldata  
Warmhalte-Vitrine  
Vitrine chauffante  
Vitrina caliente

art.	GN	cm.	Kg.	kW	range
49850-44	2x 1/1	59x35x39	15	0,65	+20 +95°C

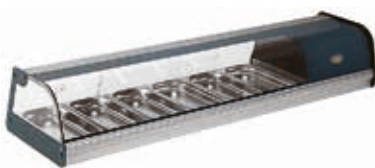

**Tapas display**

Vetrina antipasti  
Vorspeisen-Schaufenster  
Vitrine tapas  
Vitrina para tapas

art.	cm.	Kg.	W	range
49630-06	145x40x26	33	160	+2/+5°C



**Ice cream maker**

Macchina per gelato  
Eismaschine  
Machine à glace  
Maquinas helado

art.	cm.	lt.	kg./H	Kg.	kW
49949-19	51x31x35	1,5	3	30	0,4





**Dehydrator for fruits and vegetables**

Disidratatore per frutta e verdura  
Dehydratisierapparat  
Déshydrateur fruits et légumes  
Deshidratador de frutas y verduras

art.	cm.	Kg.	kW	range
49953-02	43,5x29x21	3,6	0,53	+30 +80°C

**Supplied with 6 reversible trays. Timer up to 72 hours.**  
6 vassoi reversibili. Timer fino a 72 ore.

**Smoker, 2 levels**

Affumicatoio a 2 piani  
Räucherofen  
Fumoir  
Ahumador

art.	cm.	Kg.	kW
49850-63	45x45x35	25	1,5

**Table-top cutter**

Cutter da tavolo  
Gemüseschneidmaschine  
Cutter à légumes  
Cortador verduras

art.	cm.	lt.	Kg.	V
49979-03	32x52x62	3	12	115-220-240

**Single phase. Anodised aluminium, s/s container and blades, transparent lid.**  
Monofase. Alluminio anodizzato, contenitore e lame inox, coperchio trasparente.

**Electric peeler**

Pelatrice elettrica  
Elektr. Schälmaschine  
Eplucheur électrique  
Pelador eléctrico

art.	cm.	Kg.
49750-00	25x16x21,5	2

**Dualit.****Waffle iron**

Macchina per cialde  
Waffeleisen  
Gufrier  
Gofrera

art.	cm.	Kg.	kW
49809-00	40x22x19	5,5	1,6





**Single waffle iron, GESIMPLE**

Macchina per cialde  
Waffeleisen mit 1 Platte  
Gaufrier simple  
Gofrera singular

art.	cm.	Kg.	kW
49850-24	30,5x44x23	22	1,6

**Squares 20x25 mm.**



**Single waffle iron, GESIMPLE**

Macchina per cialde  
Waffeleisen mit 1 Platte  
Gaufrier simple  
Gofrera singular

art.	cm.	Kg.	kW
49850-25	30,5x44x23	22	1,6

**Squares 15x18 mm.**



**Single waffle iron, GESIMPLE**

Macchina per cialde  
Waffeleisen mit 1 Platte  
Gaufrier simple  
Gofrera singular

art.	cm.	Kg.	kW
49850-26	30,5x44x23	22	1,6



**Single waffle iron, GESIMPLE**

Macchina per cialde  
Waffeleisen mit 1 Platte  
Gaufrier simple  
Gofrera singular

art.	cm.	Kg.	kW
49850-27	30,5x44x23	22	1,6



**Single waffle iron, GES23**

Macchina per cialde  
Waffeleisen mit 1 Platte  
Gaufrier simple  
Gofrera singular

art.	cm.	Kg.	kW
49850-03	30,5x44x23	22	1,6



**Infrared lamp with warming plate**

Lampada ad infrarossi con piano caldo  
Infrarot Wärmebrücke mit Wärmeplatte  
Lampe infrarouge avec plaque chauffante  
Lámpara infrarrojos y placa caliente

art.	GN	cm.	kW
49993-21	1/1	38x53x70	0,5
49993-22	2/1	70x53x71	1,0
49993-23	3/1	103x53x70	1,5

**Curved plexiglass fender. Separate switches for plate and lamps. Adjustable thermostat +30°C +90°C.** – Parafiato in plexiglass curvo. Interruttori di accensione separati per piano caldo e lampade. Termostato regolabile +30°C +90°C.

**SS**



**Infrared lamp**

Lampada ad infrarossi  
Infrarot Wärmebrücke  
Lampe infrarouge  
Lámpara infrarrojos

art.	GN	cm.	kW
49993-01	1/1	38x53x70	0,25
49993-02	2/1	70x53x71	0,50
49993-03	3/1	103x53x70	0,75

**Curved plexiglass fender.** – Parafiato in plexiglass curvo.

**SS**



SS

**Warming plate**

Piano caldo  
Wärmeplatte  
Plaque chauffante  
Placa caliente

art.	GN	cm.	kW
49993-11	1/1	33x53x6	0,25
49993-12	2/1	66x53x6	0,50
49993-13	3/1	132x53x6	0,75

**Adjustable thermostat +30°C +90°C. – Termostato regolabile +30°C +90°C.**



SS

**Table with hot box**

Tavolino con box termico  
Tisch mit Hot Box  
Table avec hot box  
Carrito con hot box

art.	Ø cm.	h. cm.	W
44094-02	90/54,6	77	500

**Table with fold down flaps. – Tavolo con flaps pieghevoli.**



SS

**Table with hot box**

Tavolino con box termico  
Tisch mit Hot Box  
Table avec hot box  
Carrito con hot box

art.	Ø cm.	h. cm.	W
44094-04	90/54,6	78,6	500

**Table with fold down flaps. With capsizable top for stacking when not in use. – Tavolo con flaps pieghevoli. Ribaltabile e impilabile quando non in uso.**



SS

**Table with hot box**

Tavolino con box termico  
Tisch mit Hot Box  
Table avec hot box  
Carrito con hot box

art.	Ø cm.	h. cm.	W
44094-06	90/73	76	500

**Table with fold down flaps. Foldable for saving space when not in use. – Tavolo con flaps pieghevoli. Pieghevole per ridurre l'ingombro quando non in uso.**

**Mixer/liquidiser combi unit**

Combi mixer/frusta  
Kombigerät  
Combiné mixeur-fouet  
Brazo triturador/batidor, unidad combinada

art.	h. cm.	Kg.	kW	rpm
49907-01	79	4,95	0,35	15000

**For containers up to 100 liters. – Per contenitori fino a 100 litri.**

**Liquidiser**

Mixer  
Stabmixer  
Mixeur  
Brazo triturador

art.	h. cm.	Kg.	kW	rpm
49907-06	55,5	1,45	0,25	15000

**For containers up to 30 liters. – Per contenitori fino a 30 litri.**







**Wall rack**

Supporto murale  
Wandständer  
Support murale  
Soporte mural

art.  
49907-AA



**Mini mixer**

Mini mixer  
Mini-Stabmixer  
Mini mixeur  
Mini batidora

art.	h. cm.	Kg.	kW	rpm
49808-00	40	0,78	0,45	12500-14000

SS

ABS



**Liquidiser**

Mixer  
Stabmixer  
Mixeur  
Brazo triturador

art.	h. cm.	Kg.	kW	rpm
49911-24	24	1,4	0,27	2000-12500
49916-25	25	3,0	0,27	2300-9600
49916-35	35	3,3	0,35	2300-9600
49916-45	45	4,9	0,44	1500-9000
49916-55	55	5,2	0,75	9000



**Mixer/liquidiser combi unit**

Combi mixer/frusta  
Kombigerät  
Combiné mixeur-fouet  
Brazo triturador/batidor, unidad combinada

art.	h. cm.	Kg.	kW	rpm
49911-19	19	1,9	0,25	2000-12500
49911-30	30	3,1	0,30	2300-9600
49911-35	35	5,9	0,44	1500-9000
49911-45	45	6,1	0,50	1500-9000



**Juice extractor J80 Ultra**

Centrifuga  
Fruchtpresse  
Centrifugeur-presse agrumes  
Centrifugadora/exprimidor jugos

art.	cm.	kg./H	Kg.	kW	rpm
49949-20	23,5x42x50,5	60	11	0,7	3000



**Vegetable preparation machine CL 50 Ultra**

Tagliaverdure  
Gemüseschneidmaschine  
Coupe-légumes  
Cortador verduras

art.	cm.	Kg.	kW	rpm
49940-01	30x36x55,5	15	0,55	375

**Suitable also for cutting mozzarella. For cutting discs contact our customer service. – Ideale anche per tagliare mozzarella. Per i dischi di taglio contatta il ns customer service.**





**Cutter & vegetable slicer R301 Ultra**

Combinato cutter/tagliaverdure  
Gemüseschneid/- u. Schälmaschine  
Cutter/Coupe-légumes  
Cortador verduras

art.	cm.	lt.	Kg.	kW	rpm
49942-01	28,5x36x40	3,7	14	0,65	1500

**For cutting discs contact our customer service.**  
Per i dischi di taglio contatta il ns customer service.

**Cutter & vegetable slicer R502 VV**

Combinato cutter/tagliaverdure  
Gemüseschneid/- u. Schälmaschine  
Cutter/Coupe-légumes  
Cortador verduras

art.	cm.	lt.	Kg.	kW	rpm
49942-03	35,5x30x65,5	5,5	30	1,3	300>3500

**For cutting discs contact our customer service.**  
Per i dischi di taglio contatta il ns customer service.

**Table-top cutter R4**

Cutter da tavolo  
Gemüseschneidmaschine  
Cutter à légumes  
Cortador verduras

art.	cm.	lt.	Kg.	kW	rpm
49943-01	21x32x43	4,5	17	0,9	1500/3000

**Table-top cutter R5 plus**

Cutter da tavolo  
Gemüseschneidmaschine  
Cutter à légumes  
Cortador verduras

art.	cm.	lt.	Kg.	kW	rpm
49943-02	28x34x48	5,5	24	1,2	1500/3000

**Emulsifier-mixer Blixer 4**

Omogeneizzatore  
Mixergerät  
Emulsionneur-mixer  
Omogenizador/emulsificador

art.	cm.	lt.	Kg.	kW	rpm
49944-01	46x22,5x30,5	4,5	18	1	1500/3000

**Emulsifier-mixer Blixer 4 VV**

Omogeneizzatore  
Mixergerät  
Emulsionneur-mixer  
Omogenizador/emulsificador

art.	cm.	lt.	Kg.	kW	rpm
49944-02	46x22,5x30,5	4,5	18	1,1	300>3500





**Sieving juicer C80**

Centrifuga  
Passiermaschine  
Centrifugeuse  
Centrifugadora

art.	cm.	kg./H	Kg.	kW	rpm
49946-01	61x36x54	50	21	0,65	1500



**Citrus fruit squeezer**

Spremiagrumi  
Zitruspresse  
Presse agrumes  
Exprimidor cítricos

art.	cm.	Kg.	kW	rpm
49922-01	20x30x35	5	0,13	1500



**Citrus fruit squeezer**

Spremiagrumi  
Zitruspresse  
Presse agrumes  
Exprimidor cítricos

art.	cm.	Kg.	kW	rpm
49922-02	20,5x30,5x49	10	0,23	1500-1800



**Citrus fruit squeezer**

Spremiagrumi  
Zitruspresse  
Presse agrumes  
Exprimidor cítricos

art.	cm.	Kg.	kW	rpm
49922-03	20x30x38	10	0,23	1500-1800



**Citrus fruit squeezer**

Spremiagrumi  
Zitruspresse  
Presse agrumes  
Exprimidor cítricos

art.	cm.	Kg.	kW	rpm
49922-04	24x40x49	10	0,275	1500-1800



**Juice extractor**

Centrifuga, spremisucchi  
Fruchtpresse  
Centrifugeur-presse agrumes  
Centrifugadora/exprimidor jugos

art.	cm.	Kg.	kW	rpm
49922-06	26x47x45	16	0,8	3000-3300



**Ice crusher**

Spaccagiaccio  
Eiszerstosser  
Broyeur à glace  
Triturador de hielo

art.	cm.	Kg.	kW	rpm
49922-08	24x35x47	10	0,13	73-89

**Drink Mixer**

Frullino frappè  
Getränkemixer  
Shaker électrique  
Batidora para batidos

art.	cm.	Kg.	kW	rpm
49949-09	18,6x18x53	6	0,12	8000-16000

**Equipped with 3 stirrers and 2 bowls, s/s and polycarbonate.**  
Fornito di 3 utensili agitatori e 2 bicchieri, inox e policarbonato.

**Blender**

Frullatore  
Getränkemixer  
Mixeur  
Licuadora

art.	cm.	lt.	Kg.	kW	rpm
49922-22	30x22x56,6	2	11	1,2	500-15000
49922-23	30x22x56,6	4	11	1,2	500-15000

**Stainless steel bowl. – Bicchieri inox.**



**BPA FREE**

**Blender**

Frullatore  
Getränkemixer  
Mixeur  
Licuadora

art.	cm.	lt.	Kg.	kW	rpm
49922-20	30x22x56,6	2	11	1,2	500-15000
49922-21	30x22x56,6	4	11	1,2	500-15000

**Clear bowl BPA Free. – Bicchieri trasparente BPA Free.**



**BPA FREE**

**Blender**

Frullatore  
Getränkemixer  
Mixeur  
Licuadora

art.	cm.	Kg.	kW
49922-09	20x47x44	9	3

**Clear bowl BPA Free. – Bicchieri trasparente BPA Free.**

**Citrus fruit squeezer**

Spremiagrumi  
Zitruspresse mit Spritzschutz  
Presse agrumes  
Exprimidora

art.	cm.	Kg.	kW	rpm
49958-00	31x22x34	8	0,3	1400





**Lever citrus fruit squeezer**

Spremiagrumi a leva  
Zitruspresse mit Pressarm  
Presse agrumes à levier  
Exprimidora

art.	cm.	Kg.	kW	rpm
49959-00	31x22x35	9	0,34	1400



**Blender**

Frullatore  
Getränkemixer  
Mixeur  
Licuadora

art.	cm.	lt.	Kg.	kW	rpm
49956-01	20x20x46	1,7	4	0,4	10000-15000

**Plastic bowl.** – Bicchiere plastica.



**Blender**

Frullatore  
Getränkemixer  
Mixeur  
Licuadora

art.	cm.	lt.	Kg.	kW	rpm
49957-00	23x23x52	3	5,5	1	12000-22000

**Stainless steel bowl.** – Bicchiere inox.



**Ice crusher**

Tritaghiaccio  
Eiszerstosser  
Broyeur à glace  
Trituradora de hielo

art.	cm.	Kg.	kW	rpm
49960-00	42x21x29	11	0,34	1400



**Drink mixer**

Frullino  
Getränkemixer  
Shaker électrique  
Licuadora

art.	cm.	lt.	Kg.	kW	rpm
49955-01	20x22x50	0,8	2,8	0,12	15000

**Plastic bowl.** – Bicchiere plastica.



**Rice steamer**

Cuoci riso a vapore  
Reiskocher  
Cuit riz  
Olla arroccera

art.	Ø cm.	h. cm.	lt.	kW
49954-21	5,0	35	21	3







SS

**Steamer**

Vaporiera

Dampfer

Cuit vapeur

Olla para cocinar al vapor

art.	Ø cm.	h. cm.	lt.	Kg.	V	kW
49954-18	38	46	15	7	230	2

+70°C +80°C



SS

**Water boiler with tap**

Bollitore per acqua con rubinetto

Wasserkocher mit Hahn

Chauffe-eau avec robinet

Calentador de agua con grifo

art.	Ø cm.	h. cm.	lt.	Kg.	V	kW
49954-20	37	48	20	5,7	230	2,1

+30°C +100°C

**Planetary mixer**

Impastatrice planetaria

Knet- u. Schlagmaschine

Batteur-mélangeur

Batodira planetaria

art.	cm.	lt.	Kg.	kW	rpm
49947-08	30x40x58	7,6	27	0,18	1420

3 speeds. Timer 0-15 min. – 3 velocità. Timer 0-15 min.

**Planetary mixer**

Impastatrice planetaria

Knet- u. Schlagmaschine

Batteur-mélangeur

Batodira planetaria

art.	cm.	lt.	Kg.	kW	rpm
49945-05	38x31x45,5	5	15	0,75	40>260

10 speeds. – 10 velocità.



SS

**Microwave oven - PROG**

Forno microonde

Mikrowelle

Four à micro-ondes

Microonda

art.	cm.	lt.	Kg.	kW
49997-12	54,2x46,1x32,9	30	18	1,6

5 power levels. Time key X2. Digital timer. 3 cooking stages, 5 power levels. 10 programmable keys. 20 programs.

5 livelli di potenza, da 200 a 1000W. Tasto tempo X2. Timer digitale. 3 stadi cottura e 5 livelli di potenza. 10 tasti programmabili. 20 programmi.



SS

**Microwave oven - SELF**

Forno microonde

Mikrowelle

Four à micro-ondes

Microonda

art.	cm.	lt.	Kg.	kW
49997-13	54,2x46,1x32,9	30	18	1,6

Time key X2. Digital timer. "START" button preprogrammed "1 minute" at full power. Parameters customizable.

Tasto tempo X2. Timer digitale. Tasto "START" pre-programmato "1 minuto" a piena potenza. Parametri pre-impostati personalizzabili.





**Sous-vide cooking device**

Apparecchio per cottura sottovuoto

Sous-Vide Garer

Cuiseur bain marie - sous vide

Equipo para cocinar al vacío

art.	cm.	lt.	Kg.	kW
49954-22	36x29,2x29	11	5,9	0,85

**Cooks food in vacuum-sealed pouches submerged in a water bath held at a precisely-controlled temperature from 30°C to 100°C.**

Per cuocere a bagnomaria in buste sottovuoto. La temperatura è mantenuta precisamente costante e può essere regolata da 30°C a 100°C.



**SS**

**Sous-vid water bath**

Apparecchio per cottura sottovuoto

Sous-Vide Garer

Cuiseur bain marie - sous vide

Equipo para cocinar al vacío

art.	cm.	lt.	Kg.	kW
49952-08	22x25x38	8	4	0,8

**LED touch screen controls. The temperature can be set between 30 and 90°C and time between 0 and 99 hours. Stainless steel lid and wire rack included.**

Controlli touchscreen a LED. La temperatura può essere impostata tra 30 e 90°C, tempo tra 0 e 99 ore. Coperchio e griglia in acciaio inossidabile inclusi.



**Soft cooker**

Apparecchio per cottura sottovuoto

Sous-Vide-Garer

Thermoplongeur

Máquina para cocinar al vacío

art.	cm.	Kg.	kW
49851-10	16,4x22x41,5	8	0,2

**Stainless steel structure. Suitable for containers up to 60 liters. Min. height of the tank 180 mm, electronic temperature control with 1/10°C precision, adjustable temperature 0>95°C. Pump for water circulation. Acoustic timer. Possibility to memorize up to 20 programs. Level sensor for lack of water.**

Struttura in acciaio inox. Per recipienti fino a 60 litri. Altezza minima del recipiente 180 mm, controllo elettronico della temperatura con precisione al 1/10°C, temperatura regolabile 0>95°C. Pompa per la circolazione dell'acqua. Timer acustico. Possibilità di memorizzare fino a 20 programmi. Sensore di livello per mancanza acqua.



**Induction cooker TC 3500**

Piastra ad induzione  
Induktionsplatte  
Plaque à induction  
Placa de inducción

art.	cm.	Kg.	kW
49998-35	35,5x46x11	5,5	3,5

**Stainless steel body, Schott Ceran surface. Thermocontrol. 12 power levels. Temperature preselection 60-240°C. Timer 23 hours 59 min.**  
Corpo in acciaio inox, piano Schott Ceran. Thermocontrol. 12 livelli di potenza. Preselezione temperatura 60-240°C. Timer 23 ore 59'.

**Induction cooker**

Piastra ad induzione  
Induktionsplatte  
Plaque à induction  
Placa de inducción

art.	cm.	Kg.	kW
18162-RA	30x37x10	6	2,7

**Stainless steel body, Schott ceran surface. Timer 0-180 min. 10 power levels. Temperature range 60-240°C.** – Corpo inox, piano Schott ceran. Timer 0-180 min. 10 livelli di potenza. Temperatura 60-240°C.

**Induction cooker, to be built into counter**

Piastra ad induzione da incasso  
Induktionsplatte, thekeneinbau  
Plaque à induction encastrable  
Placa de inducción para emportar

art.	cm.	Kg.	kW
18162-RB	36X38x12,5	5,7	3,5

**Schott ceran surface. Timer 0-180 min. 10 power levels. Temperature range 60-240°C.** – Piano Schott ceran. Timer 0-180 min. 10 livelli di potenza. Temperatura 60-240°C.

**Induction cooker, to be built into counter**

Piastra ad induzione da incasso  
Induktionsplatte, thekeneinbau  
Plaque à induction encastrable  
Placa de inducción para emportar

art.	cm.	Kg.	kW
49998-20	35,5x35,5x6	3,4	2

**Schott ceran surface. 5 power levels. Temperature range 60-240°C.**  
Piano Schott ceran. 5 livelli di potenza. Temperatura 60-240°C.

**Induction station**

Stazione induzione  
Induktionsstation  
Station d'induction  
Estación inducción

art.	Ø cm.	cm.	V	W
49999-04	24	35,4x32,5x19	220-240	900

**Induction plate with temperature regulator 60>140°C. Black metal support, walnut wood insert and stainless steel frame.**  
Piastra a induzione con regolatore di temperatura 60>140°C. Supporto in metallo nero, inserto in legno di noce e cornice inox.

NEW

**Coffee percolator**

Percolatore per caffè  
Kaffee-Perkolator  
Percolateur à café  
Percolator de café

art.	Ø cm.	h. cm.	lt.	W
49846-05	28	38,5	4,5	950
49846-09	28	38,5	9,2	950
49846-15	33	54,0	15,0	1650

SS





SS

**Samovar PYRAMID**

Samovar  
Samovar  
Samovar  
Samovar

art.	cm.	lt.	W
49856-04	35,5x30x45,2	4+1,2	2500

**Teapot with strainer. Cable length approx. 130 cm. With 2 heating elements 2000W and 500W.** – Teiera con colino. Lunghezza cavo circa 130 cm. Con 2 resistenze 2000W e 500W.



SS

**Samovar 2017**

Samovar  
Samovar  
Samovar  
Samovar

art.	cm.	lt.	W
49854-03	31x27,5x48,5	3+1,2	1500

**Teapot with strainer, cable length approx. 130 cm.**  
Teiera con colino. Lunghezza cavo circa 130 cm.



SS

**Samovar ROMANOV**

Samovar  
Samovar  
Samovar  
Samovar

art.	cm.	lt.	W
49855-05	34x27x59	5+1,3	1800

**Teapot with strainer. Cable length approx. 100 cm. With 2 heating elements 1300W and 500W.** – Teiera con colino. Lunghezza cavo circa 100 cm. Con 2 resistenze 1300W e 500W.



SS

**Samovar 3006C**

Samovar  
Samovar  
Samovar  
Samovar

art.	cm.	lt.	W
49854-06	35,5x30x45,2	6+1,5	2500

**Teapot with strainer. With 2 heating elements 2000W and 500W.**  
Teiera con colino. Con 2 resistenze 2000W e 500W.



SS

**Samovar SORAYA**

Samovar  
Samovar  
Samovar  
Samovar

art.	cm.	lt.	W
49855-10	35,2x44,5x69	10+1,6	3000

**Teapot with strainer. Cable length approx. 130 cm. With 2 heating elements 2300W and 700W.** – Teiera con colino. Lunghezza cavo circa 130 cm. Con 2 resistenze 2300W e 700W.



SS

**Samovar KATHARINA**

Samovar  
Samovar  
Samovar  
Samovar

art.	cm.	lt.	W
49855-15	39,5x44,5x74,5	15+2	3000

**Teapot with strainer. Cable length approx. 130 cm. With 2 heating elements 2300W and 700W.** – Teiera con colino. Lunghezza cavo circa 130 cm. Con 2 resistenze 2300W e 700W.







SS

**Chocolate fountain**

Fontana cioccolato  
Schokoladenbrunnen  
Fontaine à chocolat  
Fuente para chocolate

art.	Ø cm.	h. cm.	lt.	W
42982-08	38	80	3,5	370

**230V-50Hz-Amps 1,6A. Minimum quantity of chocolate necessary for operation is about 3.5 kg, the maximum is 8 kg.** – Quantità minima di cioccolata richiesta per funzionare è di circa 3,5 kg e può contenerne fino a 8 kg.



PP

SS

**Soup kettle**

Zuppiera  
Suppenwärmer  
Marmite à soupe  
Marmita para sopa

art.	Ø cm.	h. cm.	lt.	W
49847-38	38	36,5	10	450-550

**Soup kettle**

Zuppiera  
Suppenwärmer  
Marmite à soupe  
Marmita para sopa

art.	Ø cm.	h. cm.	lt.	W
49847-08	33	37	10	400

**Raclette maker**

Macchina per raclette  
Raclette Tischgerät  
Appareil à raclette  
Máquina raclette

art.	cm.	V	W
42420-06	44,5x21,5x30	230	850

**Foldable model with transport hook. 2 heating ramps, adjustable height. Suitable for cheese size 1/6 to 1/3 of a wheel. In stainless steel and painted steel.** – Modello pieghevole con gancio di trasporto. 2 rampe di riscaldamento, altezza regolabile. Adatto per formaggi da 1/6 a 1/3 di una forma. In acciaio inossidabile e acciaio verniciato.

**Raclette maker**

Macchina per raclette  
Raclette Tischgerät  
Appareil à raclette  
Máquina raclette

art.	cm.	V	W
42420-08	46x26,5x40	230	850

**Tiltable and easily removable cheese holder. Heating block adjustable height. Ideal for 6-8 people, 1/2 shape. Cheese holder in stainless steel and epoxy painted steel structure.** – Porta formaggio inclinabile e facilmente rimovibile. Blocco riscaldante regolabile in altezza. Ideale per 6-8 persone, 1/2 forma. Porta formaggio in acciaio inossidabile e struttura in acciaio verniciato epossidico.

**Raclette maker, 4 pans**

Macchina per raclette, 4 padelle  
Raclette Tischgerät, 4 Pfannen  
Appareil à raclette, 4 poêlons  
Máquina raclette

art.	cm.	W
41318-00	51x10x12	600

**Non-stick upper plate for all cooking (vegetables, meats, etc.).**  
Piastra superiore antiaderente per tutte le cotture (verdure, carne, ecc.).





**Sugar lamp**

Lampada per zucchero  
Zuckerlampe  
Lampe à sucre  
Lâmpara para azúcar

art.	cm.	Kg.
47840-11	61x41x50	6,4

**Stainless steel. Infrared lamp, 3 selection powers 500-1000-1500W. Cable included.** – Acciaio inox. Lampada infrarossi con 3 potenze selezionabili, 500-1000-1500W. Incl. cavo di alimentazione.



**Spray gun**

Pistola  
Sprühpistole  
Pistolet  
Pistola

art.	ml.	Kg.	W	rpm
47848-07	700	1,1	60	280

**Usable for hot liquids max. 65 °C. Equipped with nozzle 0,6 mm.**  
Per liquidi caldi max. 65°C. Bocchetta in dotazione da 0,6 mm.



**ABS**

**Tempering unit**

Temperatrice  
Temperiergerät  
Tempéreuse  
Templadora

art.	Ø cm.	h. cm.	lt.
47698-01	20,5	21,2	1,7

**For ice cream parlours, ideal for chocolate coatings of ice creams on sticks. Can be used straight on the counter. Removable anodized aluminum tank.**  
Per gelaterie, ideale per coperture in cioccolato di gelati e semifreddi su stecco. Può essere utilizzato direttamente sul banco. Vasca estraibile in alluminio anodizzato.



**ABS**

**Tempering unit**

Temperatrice  
Temperiergerät  
Tempéreuse  
Templadora

art.	Ø cm.	h. cm.	lt.
47698-02	26	16	1,8

**Mini dry melter, allows to process tiny chocolate quantities without any waste. Practical removable tank.** – Mini scioglitore a secco, adatto per piccole produzioni senza sprechi. Pratica vasca estraibile.



**SS**

**ABS**

**Tempering unit**

Temperatrice  
Temperiergerät  
Tempéreuse  
Templadora

art.	cm.	lt.
47698-03	40x24x13,5	3,6
47698-06	40x33x13,5	6,0

**Analog tempering units. Housing made with heat-resistant plastic. Removable stainless steel tank. UK/US/JAPAN/AUSTRALIA/CHINA wirings upon request.**  
Temperatrici analogiche. In materiale plastico termoresistente. Vasca inox removibile. Su richiesta cablaggio GB/USA/GIAPPONE/AUSTRALIA/CINA.



**SS**

**ABS**

**Tempering unit, digital**

Temperatrice digitale  
Temperiergerät, digital  
Tempéreuse digitale  
Templadora digital

art.	cm.	lt.
47698-07	40x33x13,5	6,0

**Made of heat-resistant plastic material, stainless steel tank and lid, thermal probe for chocolate temperature control. Tempering manually adjustable or following the 3 programs depending on the type of chocolate: white, milk and dark.** – In materiale plastico termoresistente, vasca e coperchio in acciaio inox, sonda termica per la regolazione della temperatura del cioccolato. Temperaggio regolabile manualmente o seguendo i 3 programmi in base al tipo di cioccolato: bianco, al latte e fondente.

**Airbrush compressor**

Compressore per penna aerografa  
Airbrush Kompressor  
Compresseur  
Compresor

art.	cm.	W
47844-06	16x30x23	200

**Cap. 4 bar.**

**Caramelizer**

Caramellizzatore  
Caramelisier-Eisen  
Carameliseur  
Quemador

art.	Ø cm.	W
47847-10	10	0,65
47847-12	12	1,00

**Caramelizer**

Caramellizzatore  
Caramelisier-Eisen  
Carameliseur  
Quemador

art.	l. cm.	W
47847-23	23	1,5

**Meat mincer**

Tritacarne  
Fleischwolf  
Hachoir  
Picadora de carne

art.	cm.	Kg.	kW
49921-00	18x42x43	6	0,35

**Gravity slicing machine**

Affettatrice a gravità  
Schräg Aufschnittmaschine  
Trancheuse à gravité  
Cortadora de gravedad

art.	Ø cm.	cm.	Kg.	rpm
49975-19	19,5	52x36x31,5	10	300
49975U19*	19,5	52x36x31,5	10	300

\*Extra CE. Built-in blade sharpener. – Extra CE. Affilatoio fisso.

**Gravity slicing machine**

Affettatrice a gravità  
Schräg Aufschnittmaschine  
Trancheuse à gravité  
Cortadora de gravedad

art.	Ø cm.	cm.	Kg.	rpm
49975-25	25	62x42,5x37	15,5	300
49975U25*	25	62x42,5x37	15,5	300

\*Extra CE. Built-in blade sharpener. – Extra CE. Affilatoio fisso.





**Gravity slicing machine**

Affettatrice a gravità  
Schräg Aufschnittmaschine  
Trancheuse à gravité  
Cortadora de gravedad

art.	Ø cm.	cm.	Kg.	rpm
49975-22	22	58x40,5x34	10	300
49975U22*	22	58x40,5x34	10	300

\*Extra CE. Buit-in blade sharpener. – Extra CE. Affilatoio fisso.



**Gravity slicing machine**

Affettatrice a gravità  
Schräg Aufschnittmaschine  
Trancheuse à gravité  
Cortadora de gravedad

art.	Ø cm.	cm.	Kg.	rpm
49975-30	30	65x49,5x44	23	300
49975U30*	30	65x49,5x44	23	300

\*Extra CE. Buit-in blade sharpener. – Extra CE. Affilatoio fisso.



**Gravity slicing machine**

Affettatrice a gravità  
Schräg Aufschnittmaschine  
Trancheuse à gravité  
Cortadora de gravedad

art.	Ø cm.	cm.	Kg.	rpm
49975-35	35	89x58,5x48	36	260
49975U35*	35	89x58,5x48	36	260

\*Extra CE. Buit-in blade sharpener. – Extra CE. Affilatoio fisso.

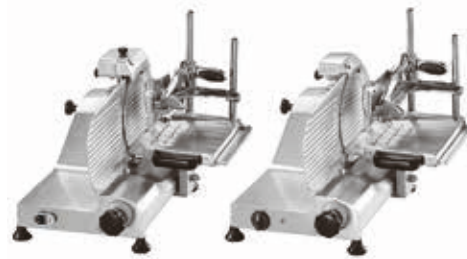

**Vertical slicing machine**

Affettatrice verticale  
Vertikal Aufschnittmaschine  
Trancheuse verticale  
Cortadora vertical

art.	Ø cm.	cm.	Kg.	rpm
49974-25	25	53x52x50	24	300
49974U25*	25	53x52x50	24	300

\*Extra CE. – Extra CE.



**Vertical slicing machine**

Affettatrice verticale  
Vertikal Aufschnittmaschine  
Trancheuse verticale  
Cortadora vertical

art.	Ø cm.	cm.	Kg.	rpm
49974-30	30	53x52x50	27	300
49974U30*	30	53x52x50	27	300

\*Extra CE. – Extra CE.







SS

**Sieve**

Passaverdura  
Passiergerät  
Moulin  
Molino

art.	Ø cm.	h. cm.	kg./H	Kg.	W
49879-37	37	108	300	23,5	600

**Threephase motor 380V. Disc 3 mm. – Motore trifase 380V. Griglia 3 mm.**



SS

**Can opener**

Apriscatole  
Dosenöffner  
Ouvre-boîte  
Abrelatas

art.	cm.	Kg.
49814-00	44x25x75	13

**Dual speed motor. Opens all can shapes from 50 to 270 mm height.  
Motore a 2 velocità. Per formati scatola da 50 a 270 mm di altezza.**



SS

**Knife sterilizer**

Sterilizzatore per coltelli  
Messerentkeimer  
Armoire de sterilisation  
Esterilizador para cuchillos

art.	cm.	W
49871-10	57,5x17x60	15

**Plexiglas door, magnetic lock. Timer setting from 0 up to 2 hours. Door with stop device when opening. Protection IP 24.**

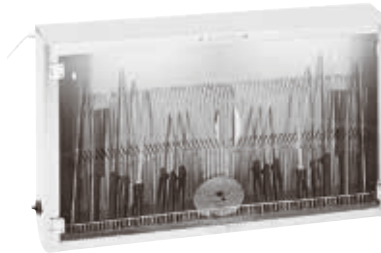

SS

**Knife sterilizer**

Sterilizzatore per coltelli  
Messerentkeimer  
Armoire de sterilisation  
Esterilizador para cuchillos

art.	cm.	W
49871-20	103x17x60	30

**Porta in plexiglas, chiusura magnetica. Programmabile da 0 a 2 ore. Dispositivo d'arresto all'apertura porta. Indice di protezione IP 24.**



Edlund

**Knife sharpener**

Affilacoltelli  
Messerschleifapparat  
Aiguiseur  
Afilador

art.	cm.	Kg.	W	rpm
49872-00	25x10x12	4	172	1550

**ABS knife guide. Pressure sensitive motor shuts down automatically.  
Guida in ABS estraibile. Motore con dispositivo autobloccante.**

**Knife sharpener**

Affilacoltelli  
Messerschleifapparat  
Aiguiseur  
Afilador

art.	cm.	Kg.
49741-15	23x33x16	6,4
49741-07	23x16x16	4,6



**GLUTEN-FREE COOKING**  
CUCINA SENZA GLUTINE

# CUCINA SENZA GLUTINE

FOR GLUTEN-FREE COOKING



**UNA LINEA COMPLETA DI ARTICOLI E STRUMENTI PROFESSIONALI FACILMENTE IDENTIFICABILI PER:**

- diminuire il rischio di accidentali contaminazioni crociate degli alimenti;
- facilitare il professionista nell'operare e nell'offrire un servizio a favore del cliente con intolleranza al glutine;
- sensibilizzare il settore sul tema "gluten free" di fronte alle nuove esigenze dei consumatori.

**A FULL LINE OF HORECA TOOLS AND ITEMS, EASY TO IDENTIFY, AIMED AT:**

- reducing the risk of accidental food cross-contamination;
- making it easier for professionals to work and to provide services to clients with gluten intolerance;
- raising awareness on the gluten-free diet issue in the industry so as to respond to the new needs of consumers.



**Frypan**

Padella

art.	Ø cm.
11014F20	20
11014F24	24
11014F28	28
11014F32	32



**Cover**

Coperchio

art.	Ø cm.
11161F16	16
11161F20	20
11161F24	24
11161F28	28



**Baking sheet alusteel**

Teglia forno, acciaio alluminato

art.	Ø cm.
11739F20	20
11739F24	24
11739F28	28
11739F32	32



**Strainer with hook**

Colapasta con manico e gancio

art.	Ø cm.
11924F20	20



**Conical colander**

Colapasta tronco conico

art.	Ø cm.
11930F24	24





**One piece ladle**  
Mestolo unipezzo



art.	Ø cm.
11970F06	6,5
11970F08	8,0
11970F10	10



**One piece skimmer**  
Schiumarola unipezzo



art.	Ø cm.
11971F10	10
11971F12	12



**One piece perforated spatula**  
Paletta forata unipezzo



art.	Ø cm.
11973F10	10
11973F12	12



**One piece basting spoon**  
Cucchiaione unipezzo



art.	
11982F38	



**Stock pot**  
Pentola alta



art.	Ø cm.
12001F20	20
12001F24	24
12001F28	28



**Saucepot 2 handles**  
Casseruola alta 2 maniglie



art.	Ø cm.
12007F16	16
12007F24	24
12007F28	28



**Colander for low stock pot**  
Colapasta per pentola bassa



art.	Ø cm.
12123F20	20
12123F24	24
12123F28	28



**Wire whip, 8 wires**  
Frusta 8 fili



art.	l. cm.
12928F30	30
12928F35	35



**Egg whisk, 11 wires**  
Frusta 11 fili



art.	l. cm.
12929F30	30
12929F35	35



**Gastronorm Container**  
Bacinella gastronorm



art.	GN	dim. cm.
14102F02	1/1	53x32,5x2
14102F04	1/1	53x32,5x4
14102F06	1/1	53x32,5x6,5
14102F10	1/1	53x32,5x10
14102F15	1/1	53x32,5x15
14102F20	1/1	53x32,5x20
14103F02	2/3	35,3x32x2
14103F04	2/3	35,3x32x4
14103F06	2/3	35,3x32x6,5
14103F10	2/3	35,3x32x10
14103F15	2/3	35,3x32x15
14103F20	2/3	35,3x32x20
14104F06	2/4	53x16,2x6,5
14104F10	2/4	53x16,2x10
14104F15	2/4	53x16,2x15
14105F02	1/2	32x26,5x2
14105F04	1/2	32x26,5x4
14105F06	1/2	32x26,5x6,5
14105F10	1/2	32x26,5x10
14105F15	1/2	32x26,5x15
14105F20	1/2	32x26,5x20
14107F06	1/3	32,5x18x6,5
14107F10	1/3	32,5x18x10
14107F15	1/3	32,5x18x15
14107F20	1/3	32,5x18x20
14108F06	1/4	26,5x16x6,5
14108F10	1/4	26,5x16x10
14108F15	1/4	26,5x16x15
14108F20	1/4	26,5x16x20
14109F06	1/6	17,6x16x6,5
14109F10	1/6	17,6x16x10
14109F15	1/6	17,6x16x15
14109F20	1/6	17,6x16x20
14110F06	1/9	17,6x11x6,5
14110F10	1/9	17,6x11x10



**Gastronorm cover**  
Coperchio gastronorm



art.	GN
14502F00	1/1
14503F00	2/3
14504F00	2/4
14505F00	1/2
14507F00	1/3
14508F00	1/4
14509F00	1/6
14510F00	1/9



**GN-lids****GN coperchi**

art.	GN	dim. cm.
14922-77	1/1	53x3,25
14925-77	1/2	32,5x26,5
14927-77	1/3	32,5x17,5
14928-77	1/4	26,4x16,2
14929-77	1/6	17,6x16,2
14930-77	1/9	17,6x10,8

**GN-containers****GN bacinelle**

art.	GN	dim. cm.	lt.
15101-10	1/1	53x32,5x10	13,3
15105-10	1/2	32,5x26,5x10	6,1
15107-10	1/3	32,5x17,5x10	3,8
15108-10	1/4	26,4x16,2x10	2,6
15109-10	1/6	17,6x16,2x10	1,6
15110-10	1/9	17,6x10,8x10	0,9

**Bread knife****Coltello pane**

art.	l. cm.
18028F21	21
18028F25	25
18028F30	30
18028F36	36

**Pizza wheel****Rotella tagliapizza**

art.	Ø cm.
18324F10	10

**Spatula perforated****Spatola pasticcio e pizza forata**

art.
18510F07

**Pizza turner****Spatola per pasticcio e pizza**

art.
18511F15

**Pastry spatula****Spatola per dolci**

art.
18513F14

**Perforated pizza peel, aluminum****Pala pizza forata, alluminio**

art.	Ø cm.	dim. cm.	l. cm.
41704G33	-	33x33	150
41704G36	-	36x36	150





**Perforated pizza peel, small**  
Palettino pizza forato

art.	Ø cm.	dim. cm.	l. cm.
41737G20	20	-	150
41737G23	23	-	150



**Adjustable brush**  
Spazzola orientabile

art.	Ø cm.	dim. cm.	l. cm.
41767G20	-	20x6	160



**Baking sheet alusteel**  
Teglia rettangolare, alluminata

art.	dim. cm.
41751F30	30x23x3
41751F40	40x30x3
41751F60	60x40x3



**Cutting board**  
Tagliere

art.	GN	dim. cm.	col.
42522-07	-	32x26,5x2	●
42538-07	1/1	53x32,5x2	●
42539-07	-	60x40x2	●



**Cutting board**  
Tagliere

art.	GN	dim. cm.	col.
42522F09	1/2	32x26,5x2	●
42538F09	1/1	53x32,5x2	●
42539F09	-	60x40x2	●



**Labels 14 allergens**  
Etichette 14 allergeni

art.	dim. cm.	Pcs/Pz
44630-02	7,5x4	500

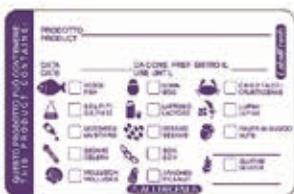

**Labels Allergens**  
Etichette allergeni

art.	dim. cm.	Pcs/Pz
44630-06	7x4,5	500



**Delivery labels with allergens**  
Etichette delivery con allergeni



art.	dim. cm.	Pcs/Pz
44630-07	14x4,5	250

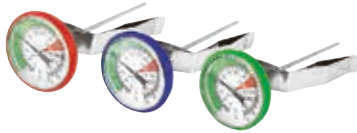

**Milk frothing thermometers, 3 pcs**  
Termometri latte/barista, 3 pz



art.	Ø cm.		
49709-03	4,5	-10+110°C	1°C



**Digital thermometer**  
Termometro digitale



art.		
49880-17	-49,9>299,9°C	0,1/1°C



**Bread tongs**  
Molla pane



art.	l. cm.
52550F63	23



**Spaghetti tongs**  
Molla spaghetti



art.	l. cm.
52550F73	21



**Toast-pastry tongs**  
Molla toast-dolci



art.	l. cm.
52550F78	24



**Cake pliers**  
Pinza torta



art.	l. cm.
52550F80	28



**Pastry pliers**  
Pinza dolci



art.	l. cm.
52550F88	18

**SPARE PARTS  
RICAMBI**



**Tap/Rubinetto : For/Per # 11102**

art.  
11102-99



**Roasting pan grid/Griglia brasiera : For/Per # 11965**

art.	dim. cm.
11966-50	50x30
11966-60	60x35
11966-61	61x43



**Clutch left, Asia rectangular/Frizione sx Asia rettangolare**

art.  
18132-KP



**Clutch right, Asia rectangular/Frizione dx Asia rettangolare**

art.  
18132-KQ

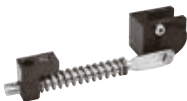

**Clutch right Asia /Frizione dx Asia**

art.	Ø cm.
18136-KQ	33-40



**Clutch left, Asia/Frizione sx Asia**

art.	Ø cm.
18136-KP	33
18136-KR	40



**Clutch spring for rect. ABS, long side opening/Frizione molla ABS rett., apertura lato lungo**

art.  
18162-AF



**Clutch spring for rect. ABS, short side opening/Frizione molla ABS rett., apertura lato corto**

art.  
18162-AG





#### Spare parts/Ricambi : For/Per # 18166A

art.	des	Ø cm.
18166-AD	Clutch/Frizione	24
18166-AE	Clutch/Frizione	36
18166-AF	Clutch/Frizione	40
18166-AH	Clutch/Frizione	30



#### Spare parts/Ricambi : For/Per # 18172A54

art.	des
18172-AF	Clutch spring/Frizione molla



#### Spare parts/Ricambi : For/Per # 18172A56

art.	des
18172-AG	Clutch spring/Frizione molla



#### Spare parts/Ricambi : For/Per # 18176A

art.	des
18176-AE	Clutch for ABS Ø cm 36/Frizione ABS Ø cm 36
18176-AF	Clutch for ABS Ø cm 40/Frizione ABS Ø cm 40
18176-AH	Clutch for ABS Ø cm 30/Frizione ABS Ø cm 30



#### Cutlery bag Borsa porta coltelli

art.
18190-AA



#### Spare parts/Ricambi : For/Per # 18353-17

art.	des
18353-AA	Juice container/Contentitore succhi
18353-BB	Tap/Rubinetto
18353-CA	Lid/Coperchio
18353-DB	Drip bowl/Ciotola raccogli gocce
18353-VA	Eutectic pad/Contentitore eutettico



#### Spare parts/Ricambi : For/Per # 19810-00

art.	des
19810-AA	Blade/Lama
19810-AB	Gear/Ruota dentata



**Spare porcelain/Ricambio porcellana : For/Per # 41311-00**

art.  
41311-AA



**Spare stand/Ricambio supporto : For/Per # 41311-00**

art.  
41311-AB



**Non slip feet/Piedini antiscivolo : For/Per # 41323**

art.	Pcs/Pz
41323-AA	6



**Folding lid/Coperchio a ribalta**

art.	Ø cm.
41400-AB	23,5
41405-AB	13,5



**Cereal-bar glass/Barattolo cereali, vetro : For/Per # 42460-43; 42470-43**

art.	lt.
41402-AA	2



**Eutectic pad/Eutettico : For/Per # 41488**

art.	Ø cm.	h. cm.
41443-AE	10,5	2



**Tray/Vassoio : For/Per # 41447-05**

art.  
41447-39



**Stoppers/Tappi pompa : For/Per # 41500-00**

art.	Pcs/Pz
41500-AA	2

**China cup/Porcellana : For/Per # 41563-07**

art.

41563-AA

**China cup/Porcellana : For/Per # 41564-07,**

art.

41564-AA

**Cheese jar/Vetro formaggiera : For/Per # 41638-01**

art.

Ø cm.

41638-91

10,5

**Spare parts/Ricambi : For/Per # 41638-02-04-12-13**

art.

des

Ø cm.

h. cm.

lt.

41638-92

Oil/Winegar bottle/Ampolla olio/acetato

6

18,5

0,2

41638-93

Salt shaker/Spargisale - Holes/Fori 6 Ø Mm 1,85

4

9

41638-94

Pepper shaker/Spargipepe - Holes/Fori 18 Ø Mm 1,35

4

9

41638-95

Toothpick holder/Porta stecchi

4

9

**Brush/Spazzola : For/Per # 41767-20**

art.

41767-AA

**Euthetic pad/Eutettico tondo**

art.

Ø cm.

h. cm.

41910-AL

15

2,5

**Spare parts/Ricambi : For/Per # 41911**

art.

des

41911-AA

Canister/Contenitore, SAN

41911-AE

Slide/Scivolo, SAN

**Cover/Tappo : For/Per # 42401**

art.

42401-AA



**Cover/Tappo : For/Per # 42505**

art.  
42405-AA



**Set 10 blades/Set 10 lame : For/Per # 42520-00**

art.  
42520-AA



**Spare parts/Ricambi : For/Per # 42570-32**

art.	des	mm.
42570-91	Disc/Griglia	1,5
42570-92	Disc/Griglia	2,5
42570-94	Disc/Griglia	4,0
42570-99	Cranck/Manovella	



**Spare parts/Ricambi : For/Per # 42573-31**

art.	des	mm.
42573-91	Disc/Griglia	1,5
42573-92	Disc/Griglia	2,5
42573-94	Disc/Griglia	4,0
42573-99	Cranck/Manovella	



**Spare parts/Ricambi : For/Per # 42574-37**

art.	des	mm.
42574-90	Disc/Griglia	1,0
42574-91	Disc/Griglia	1,5
42574-92	Disc/Griglia	2,0
42574-93	Disc/Griglia	3,0
42574-94	Disc/Griglia	4,0
42574-99	Cranck/Manovella	



**Spare parts/Ricambi : For/Per # 42575-37**

art.	des	mm.
42575-90	Disc/Griglia	1,0
42575-91	Disc/Griglia	1,5
42575-92	Disc/Griglia	2,0
42575-93	Disc/Griglia	3,0
42575-94	Disc/Griglia	4,0
42575-99	Cranck/Manovella	



**Spare parts/Ricambi : For/Per # 42577-39**

art.	des	mm.
42577-90	Disc/Griglia	1,0
42577-91	Disc/Griglia	1,5
42577-92	Disc/Griglia	2,0
42577-93	Disc/Griglia	3,0
42577-94	Disc/Griglia	4,0
42577-99	Cranck/Manovella	



**Spare parts/Ricambi : For/Per # 42929-03**

art.	des	Ø cm.	h. cm.
42929-AA	Pepper shaker/Spargipepe - Holes/Fori 6 Ø Mm 1,85	4	9
42929-AB	Salt shaker/Spargisale - Holes/Fori 18 Ø Mm 1,35	4	9
42929-AC	Oil/Winegar bottle/Ampolla olio/acetato	6	18,5

**Glass/Vetro : For/Per # 42939-15**

art.  
42939-AA

**Glass/Vetro lampada : For/Per # 42941-22**

art.  
42941-AA

**Wheel/Ruota : For/Per # 44023-00 # 44024-00**

art.  
44023-AA

**Dish separation grid /Griglia divisoria : For/Per # 44027-00**

art.  
44027-AA

**Eutectic pad/Piastra eutettica : For/Per # 44094R00**

art.	des	dim. cm.
44094-RE	Temp. -32°C	13X23X3,5

**Sponge/Spugna : For/Per # 44101-03**

art.  
44101-AA

**Container/Contenitore : For/Per # 44103**



art.	des
44103-AA	3 comp.
44103-AB	4 comp.
44103-AC	6 comp.

**Flat mop/Frangia mop : For/Per # 44160-03**



art.
44160-AA

**Trolley bags/Sacchi carrello : For/Per # 44174-24**



art.
44174-AA

**Burner/Portacombustibile : For/Per # 44225-22; 44227-30**



art.
44220-AA

**Cream puff nozzle/Beccuccio riempi bignè : For/Per # 47612-01**



art.
47612-AA

**Knife insert/Inserto porta coltelli : For/Per # 48040-00 - 48040-10**



art.
48040-AA

**Bone-saw blade/Lama per sega : For/Per # 48231**



art.	mm.
48232-40	400
48232-45	450
48232-50	500

**Spare parts/Ricambi : For/Per # 49811-00**



art.	des
49811-01	Cutting knife kit/Kit lama
49811-02	Blade/Lama

**Spare parts/Ricambi : For/Per # 49812-00**



art.	des
49812-01	Blade and wheel/Lama e ruota dentata
49811-02	Blade/Lama

**Spare parts/Ricambi : For/Per # 49814-00**



art.	des
49811-02	Blade/Lama
49814-01	Blade and wheel/Lama e ruota dentata

**Spare parts/Ricambi : For/Per # 49818-00**

art.	des	Ø cm.
49818-AC	Blade/Lama	7,4
49818-AD	Pusher/Pressatore	7,4
49818-AE	Blade/Lama	10,2
49818-AF	Pusher/Pressatore	10,2

**Set 7 blades/Set 7 lame : For/Per # 49829-11**

art.	
49829-BA	

**Spare parts/Ricambi : For/Per # 49830-60**

art.	des
49830-00	Slicer/Mandolino
49830-02	Protective carriage/Carrello
49830-AA	38 Blades/Pettine 38 lame
49830-AB	44 Blades/Pettine 44 lame
49830-AC	60 Blades/Pettine 60 lame

**Spare parts/Ricambi : For/Per # 49832-10**

art.	des	mm.
49832-80	Pusher/Pressatore	10
49832-86	Pusher/Pressatore	6
49832-88	Pusher/Pressatore	8
49832-90	Blade/Lama	10
49832-96	Blade/Lama	6
49832-98	Blade/Lama	8
49832-99	Carriage/Guida di scorrimento	

**Spare parts/Ricambi : For/Per # 49834-00**

art.	des
49834-01	Peeling blade/Lama a pelare
49834-02	Slicing blade/Lama affettare

**Spare parts/Ricambi : For/Per # 49835-00**

art.	des
49835-01	Peeling blade/Lama a pelare
49835-02	Slicing blade/Lama affettare

**Blade assembly/Set lame : For/Per # 49837-05**

art.	
49837-AA	

**Blade assembly/Set lame : For/Per # 49838-08**



art.  
49838-AB

**Corkscrew worm/Verme cavatappi : For/Per # 49858-00**



art.  
49858-AA

**Grinding wheel assembly/Set ruota molatrice : For/Per # 49872-00**



art.  
49870-AA

**Disc/Griglia : For/Per # 49879-37**



art.	mm.
49879-90	1,0
49879-91	1,5
49879-92	2,0
49879-93	3,0
49879-94	4,0

**Pedal & opening assembly/Pedaliera e movimento : For/Per # 49899-01**



art.  
49899-AA

**Glass/Bicchieri : For/Per # 49956-01**



art.  
49956-AA

**Display for fry pans/Espositore per padelle ferro**



art.  
XO1046



# ALPHABETICAL INDEX

## INDICE ALFABETICO



Cigar scissors	370	Cream chargers	296	Duck fur pincer	262
Citrus bar knife	87	Cream dispenser	192	Dumplin maker	123
Citrus fruit squeezer electric	506>508	Cream roll/horn molds	187	Dunnage rack	493
Citrus stripper	88	Cream whipper	295	Dust beater V sweeper	488
Clay pot	261	Crème caramel	205	Dust cover	469
Cleaning system, Pulse	488	Crepe machine	498	Dustpan	488
Cleaning wand	488	Crepe spreader	101	<b>E</b>	
Clip tags for dish racks	467	Crepes pan	32, 33	Eclairs mold	245, 246
Cocktail fountain	415	Croissant cutter	196	Egg basket	427
Cocktail jigger	305	Cube cutter	114	Egg container	116
Cocktail spoon	92, 304	Cut resistant glove	167	Egg cup	352
Cocktail strainer	305	Cutlery dispenser	357, 430	Egg dish	50
Cocoa dredger	277	Cutlery holder	467, 468	Egg knocker	115
Cocoa stencils	276	Cutlery rack	467	Egg mold	224
Coffee measuring spoon	92	Cutter & vegetable slicer	505	Egg rings	116
Coffee percolator	451, 511	Cutting board HDPE	164, 165	Egg separator	92
Coffee set	280	Cutting board rack	166	Egg wedger	115
Coffee shop	275>284	<b>D</b>		Eggs boiler	498
Coffee urn	450	Dash bottle	316, 317	Electric appliances	496>517
Cognac warmer	365	Decorating combs	198	Emulsifier-mixer	505
Colander	108, 109	Decorating spoons	107, 179	Escargot dish	361
Collapsible frame	486	Decorating tips for cream whipper	295	Escargot fork	400
Condiment holder	319	Decoration tools	120	Escargot picks	361
Condiment set	356, 357	Dehydrator	501	Ethnic cuisine	249>262
Confectionery funnel	191	Digital timer	131	Eutectic pad	430, 476
Contact grill	496	Dim Sum steam rack	259	Expanding pastry cutter	196
Cookie press	188	Dipping forks	179, 359	<b>F</b>	
Cooking tongs	102, 103	Dish dolly	467	Fast food tray	480, 481
Cookware enamelled cast iron	43>48	Dish oval melamine	403	Fingesfood porcelain	337, 338
Cookware series 1000 stainless steel	14>16	Dish racks	466, 467	Fish & chips spatula PA+	80
Cookware series 1100 stainless steel	10>12	Dish-warmer	500	Fish kettle	27, 33, 40
Cookware series 12300 3-ply	441	Display tray	199, 200	Fish scaler	84, 85, 88, 262
Cookware series 12300 3-ply	441	Disposable baker's blades	248	Fish-bone remover	102
Cookware series 15200 copper 3-ply mini pans	38	Disposable covers	481	Flair bottle	315
Cookware series 15300-15400 tinned copper	39, 40	Disposable forks & spoons	326	Flambé trolley	457, 458
Cookware series 15500 copper 3-ply induction	36, 37	Dollies	189	Flavour marker	287, 288
Cookware series 16130 aluminum mini pans	41	Dolly for cases	484	Flexipan baking sheets	232>247
Cookware series 2000 stainless steel	17>19	Dolly for PPE containers	476	Floor sign	489
Cookware series 2100 stainless steel	13	Dolly with handle	468	Floor standing ashtray	493
Cookware series 2500 3-ply	23>25	Dome cover	358	Flour brush	199
Cookware series 6100 aluminum	29>33	Dough box	271	Flour scoop	107
Cookware series Gluten Free stainless steel	21, 518, 519	Dough cutter	271	Flour sieve	107
Cookware, pots & pans	10>48	Dough plunger cutters w/extractor	178, 179	Flour sifter	199
Cool bowl	431>432	Dough scraper	198, 271	Flower vase	365
Cooled buffet showcase	429, 430	Drainer	231	Foil cutter	324
Counter showcase	283, 284	Drainer plate	60	Folding ladder	493
Couscous pan	30	Draining rack	190	Fondue set	40, 359
Cover clamps Weck	349	Drawer	407	Food container	471, 472, 478
Cover for bowls	431	Drink mixer	508		
Cover for bread basket	425				

Food-grade resin spatula	103	Grater	85, 90, 118, 122, 123	Icing bags & nozzles wall rack	189
Foodloops	113	Gravity slicing machine	515	Icing sugar sieve	199
Forged knives	136>138	Griddle plate	46	Induction adapter	110
Free flow pourer	322	Grill pan	45	Induction cooker	453, 511
French fry cutter	117	Gueridon trolley	457	Infrared lamp	502
French fry scoop	101	Guitar	195	Ingredient bin	472
French press	350	<b>H</b>		Insulated beverage server	349, 350
French stick bread basket	423	Ham boner	151	Insulated container	475>478
Fruit basket	311, 312, 353	Ham knife	137, 143	Insulated dispenser	439
Fruit stand	415, 433, 434	Ham stand	162	<b>J</b>	
Fry basket	60, 262	Ham tongs	161	Jam bar	437
Fry dripping tray	27	Hamburger press	163	Japanese sushi knives	155, 156
Fryer	499	Hand roll stand	252	Jar opener	90
Frying oil tester	131, 132	Hangiri/sushi rice tub	258	Jelly fuel	455
Frying pans steel	34, 35	Heat accumulator	476	Juice dispenser	438, 439
Fuel Holder	454	Heating units electric	455	Juice extractor	504, 506
Funnel	105	Herb mill	124	Juice pitcher	350, 351
<b>G</b>		Herb scissors	117	Julep mug	300, 301
Ganache frame set	195	Herbs/chili mill	385	Julep strainer	305
Garlic press	90, 118	Honey/cream dispenser	277	<b>K</b>	
Gastronorm basket	473	Hors d'oeuvre trolley	458	Kaiser bread marker	248
Glass bowl	431	Hot dog heater	498	Kebab/Gyros grill	498
Glass cleaning brush	321	Housekeeping cart	487	Kitchen utensils	78>135
Glass clip holder	326	Hydrometer for brine/salt	131	Kitchen utensils PA+	79>82
Glass rack	321	Hygienic cover	422	Kitchenbowl	108
Glass rimmer	319	<b>I</b>		Knife block	158, 159
Glasses	308>311	Ice bucket	315, 478	Knife case	157
Glasses Weck	347, 348, 349	Ice cart	478	Knife roll-bag	158
GLUTEN FREE products	518>523	Ice chisel	121	Knife sanitizing system	159
GN baking sheets aluminum/non stick	58	Ice cream basin	286	Knife sharpener electric	517
GN food pans	51>77	Ice cream cone holder	288>290	Knife sterilizer	517
GN food pans induction porcelain	76, 77	Ice cream container	286	Knives	136>158
GN food pans melamine	72, 73	Ice cream counter display	294	<b>L</b>	
GN food pans PC	61, 62	Ice cream cup	290>292	Labels	132, 133
GN food pans porcelain	74, 75	Ice cream maker	500	Ladle	100
GN food pans PP	67>71	Ice cream mold	293, 294	Ladle PA+	80, 81
GN food pans stainless steel	52>58	Ice cream scoop	91, 287	Lanterns	418
GN food pans Tritan	63, 64	Ice cream server	286	Led candles	367, 418
GN hermetic lids with overmolded GASKET	69	Ice crusher electric	507	Lemon squeezer	312
GN-baking sheets	58, 59	Ice crusher manual	313	Lever dispenser	106
GN-containers non stick coated	55	Ice knife	121	Lightning column	413
GN-containers, falling handles	55	Ice molds	314	Liquidiser	503, 504
GN-containers, fixed handles	53, 54	Ice pick	313	Lobster cracker	361
GN-containers, internal handles	54	Ice scoop	313, 478	Lobster forks	361
GN-lid with silicone seal	62	Ice tongs	315, 398	Lobster pick	361
GN-lids	57	Ice-box	429		
GN-lids, hermetic	64	Ice-Cream	285>296		
Graduated bucket	109, 490	Icing bag	187, 188		
Grapefruit knife	87, 91	Icing bag holder	189		



<b>M</b>		
Magnetic knife rack	159	
Mandoline	118, 119	
Manual sharpener	159	
Manual slicing machine - Flywheel	163	
Marinating syringe	102	
Martini/margarita cup	298	
Measuring jug	105	
Measuring pourer	323	
Meat cleaver	149, 150	
Meat fork	100, 138, 151	
Meat hooks	160, 161	
Meat mincer electric	515	
Meat pan	162	
Meat tenderizer	161, 162	
Mechanical sweeper	488	
Melon baller	86, 91	
Melon peeler	87	
Menu stand	367	
Microfibre cloth	489	
Microfibre mops	488	
Microwave oven	509	
Milk dispenser	438, 439	
Milk pot with lid	277	
Mincing knife	151	
Minibar restocking cart	483	
Mirrors	417	
Mixer/liquidiser combi unit	503	
Mixing bowl	40, 108, 110	
Mixing glass	308	
Mobile pedal bin	492	
Mobile plate rack	479	
Moisture bottle	199	
Mooncake mould	256	
Mop holder	489	
Mopping trolley with press	490	
Mortar and pestle	261	
Moscow mule mug	298>300	
Mozzarella/tomato cutter	113	
Muddler	313	
Multi rack	435, 436	
Multifunction oven	499	
Mushroom cutter	116	
Mussel pot	360	
Mustard cup	352	
<b>N</b>		
Napkin holder	278, 279, 358	
Newspaper stick	368	
Nigiri mold	257	
Nitro Whip	276	
Nozzles	180>186	
Nut-cracker	361	
Nutmeg grater	123	
Nutmeg mill	383, 386	
<b>O</b>		
Octopus-press	113	
Odor eliminator soap bar	92	
Oil pourer	261, 264	
Oil/vinegar sprayer	356	
One piece basting spoon	98, 99	
One piece ladle	98, 99	
One piece meat fork	98, 99	
One piece skimmer	99, 100	
One piece spatula	99	
One-hand mincing knife	84	
Orange juicer manual	312	
Orange peeler	87, 91	
Oven dishes	50	
Oven dishes APPOLIA PEUGEOT	388>395	
Oven mitt	166, 167	
Oyster fork	399	
Oyster knife	84, 90, 150	
Oyster plate	415	
Oyster tray	362	
<b>P</b>		
Pallet	493	
Pan gripper	267	
Paper napkins holder	288	
Paring knife	89, 138, 146	
Parmesan cheese knife	84, 89, 150	
Party plate	403	
Party spoon	405	
Pastry brush	198	
Pastry cutters PA+	178	
Pastry cutters stainless steel	169>177	
Pastry utensils	168>248	
Pastry wheel	84, 88, 196	
Peeling machine	115, 501	
Pepper/salt mill PEUGEOT	374>385	
Perforated GN-containers	56	
Pie knife	151	
Pie server	96	
Piepans aluminum	206	
Pineapple coring tool	86	
Pineapple cup	298	
Pineapple-peeler/corer	114	
Pinneapple slicer	115	
Piping tip adapter	186	
Pizza cutter	267	
Pizza delivery bag	269, 270	
Pizza items	263>274	
Pizza pan	272, 273	
Pizza pan rack	272	
Pizza peel	264>267	
Pizza screen	272	
Pizza wheel	84, 88, 267	
Planetary mixer	509	
Plate cover	104, 433	
Plate melamine	402, 404, 406, 408	
Plate warmer	360	
Platform cart	484	
Pocket crumbler	358	
Polycarbonate Christmas molds	225	
Polycarbonate Easter molds	225	
Portion rings	112	
Potato fork	91	
Potato masher	90	
Potato peeler	87, 91, 117	
Potato ricer	117	
Poultry shears	152	
Pourer	365	
Praline's polycarbonate molds	217>223	
Praline's silicone molds	216	
Presse canard	113	
Pretzel stand	422	
Protective apron	166	
Pumpkin mug	298	
Punch bowl	416	
<b>R</b>		
Raclette maker	359, 513	
Rapid infusion kit	296	
Reception bell	368	
Refrigerated box	463, 480	
Refuse bag holder trolley	492	
Retractable barrier set	494	
Rice bowl	250, 252	
Rice scoop	112	
Rice spoon	257	
Rice steamer	508	
Roast beef/stew trolley	457	
Roasting pan	27	
Roll holder	104, 481	
Rolling pin	197	
Roll-top cover	425, 428>430	
Room service table	463, 464	

Room service tray	461	Silicone molds	226>231	Store & pour container	317, 318
Room serving trolley	462, 464	Sink trolley	472	Strainer	109, 111
Rouet	120	Skewers	160, 256, 325, 326	Strainer PA+	82
Rubber comb, wood effect	214	Skimmer	100, 101	Straw holder	278
Rubber rings Weck	349	Skimmer PA+	80, 81	Straws	302, 303
Ruler	194	Slotted turner	100	Straws case	289
Runner	341	Smoker	501	String holder	162
<b>S</b>		Smoking chips	316	String mop	489
Safety chain for floor signs	489	Smoking gun	315	Sturdy chair	486
Sake cup	254	Smoking gun dome cover	316	Sugar bulb	193
Sake jug	254	Smoother	194	Sugar dredger	199
Sake warmer	254	Snack holder	327, 328	Sugar gloves	167
Salad bowl	353	Snail tongs	396	Sugar lamp	193, 514
Salad bowl melamine	406	Soda chargers	313	Sugar packet holder	278
Salad spinner	111	Soda siphon	313	Sugar pourer	277
Salamander	497	Soufflé pot	44, 48	Sugar saucepan	40
Salami pricker	159	Soup bowl, lion-headed	353	Sugar tongs	398
Salmon knife	137, 143, 145	Soup kettle electric	452, 513	Sushi geta board	252
Salt tester	131	Sous-vide cooking device	510	Sushi mat	257
Salt/pepper shaker	355	Soy pot	254	Sushi-sashimi boat	253
Samovar	450, 451, 512	Space saving box	473	Sushi-sashimi bridge	252
Sandwich board	368	Spaghetti spoon	100	Swivelling table top rack	479
Sauce boat	352	Spaghetti tongs	397	Syrup density meter	194
Sauce bowls melamine	335	Spare parts	524>532	Syrup hydrometer	131
Sauce ladle	100	Spatulas PA+	79	<b>T</b>	
Sauce pot	334	Spatzle sieve	123	Table accessories series Natural slate	342, 343
Sauce pourer	253	Speed rack	103, 321	Table bag holder	363
Saucepot platter	44	Spiked roller	196	Table barbecue	46, 360
Saucepot stand	44	Spits, disposable	326	Table bread basket	353, 354
Scales	133>135	Spoon and cup holder	277, 289	Table caddy	357
Scissors	153, 154	Spoon mold	223	Table cigar cutter	369
Scrubbing gloves	167	Spoon PA+	79	Table crumbler	358
Sea urchin cutter	361	Spray gun	192	Table mat	341
Seafood display rack	362	Spray gun	514	Table number stand	367
Segment colander	28	Spraying bottle	199	Table sign	367
Serving board melamine	408	Squeeze bottle	106, 107	Table top	339>370
Serving boards	330>334	Stackable container	473, 474	Table top can opener	125
Serving box	346	Stamped knives	139>147	Table top waste bin	361
Serving stand	312, 402, 432, 436	Stand with grill stone	359	Table with hot box	480, 503
Serving tongs	102	Stand/basket	413	Table-cloth clips	358
Serving trolley 2/3 tiers	482, 483, 487	Steak knife	138, 145, 146	Table-top cutter	501, 505
Shaker	306, 307	Steamer	257, 261	Tamagoyaki pan	260
Sharpening steel	152	Steamer electric	509	Tart mold	211, 212
Sharpening stone	152	Stencils	216	Tart ring	202
Showplate buffet set	428, 429	Step on bin	492	Tasting bowls/glasses	335, 336
Sieve electric	517	Sticky rice lao pot	258	Tasting/dessert set	328, 329
Sieve for flour	199	Stirrers	303, 304	Tawa pan	260
Sign holders	367, 427	Storage box	470	Tea strainer	352
Silicone baking sheet	201	Storage canister	318	Tea-box	278
		Storage, transport, cleaning	468>494		

Teapot	254, 255	Vegetable preparation machine	504
Telescopic door sign	490	Vegetable sharpener	85
Telescopic rod	489	Vegetable sieve	111, 124
Tempering unit	193, 294, 295, 514	Ventilated warming display	500
Tempura rack	259	Vertical manual sausage filler	163
Thai knife	120	Vertical slicing machine	516
Thermic hot box	463, 480	Vinyl bag	487
Thermo cover	479	<b>W</b>	
Thermohygrometer	131	Waffle case	289
Thermometers	126>132	Waffle iron	501, 502
Thermoregulator	455	Waiter's corkscrew	324
Tickets-holder	103	Waiter's corkscrew case	325
Tiki mug	301, 302	Wall board	368
Tilt truck	492	Wall clock	133
Toast rack	352	Wall draining rack	469
Toaster	496	Wall film box	104
Toban skillet	259	Wall rack	100
Tomato cutter	114	Wall rack for icing bags	189
Tomato juicer sieve	124	Wall rack for nozzles	189
Tomato peeler	87	Warming display	500
Tongs and serving pliers series Living	397>400	Warming plate	503
Tongs PA+	80	Wasabi grater	261
Toothpicks	326	Waste container	490, 491
Tortillas cup	48	Water boiler with tap	509
Tortillas wedger	117	Water jug	310, 350, 351
Towel tray	252	Weck glasses serving stand	349
Tray stainless steel	418, 419	Wedding cake stand	415
Tray stand	418	Wedger	114, 115
Tray with dome cover	355	Wet mop handles	488
Trays & bowls melamine series Thara	250, 251	Whisk	100, 103
Trays melamine	403, 404, 407, 410	Whisk PA+	82
Trivet	360	Whistling kettle	27
Trolley 3 levels	469	Wine bucket	363
Trolley convertible	484	Wine bucket table clip	363
Trolley Quick Cart	486	Wine collar	365
Trolleys	457>464	Wine cooler stand	363
Truffle server	355	Wine holder	364
Truffle-slicer	355	Wine stopper	323
Trussing needle	160	Wine taster	365
Turners	95, 96	Wine/liqueur trolley	460
Tweezer	304	Winged corkscrew	324
<b>U</b>		Wire dish rack	469
Universal tray collector trolley	481	Wire grid	60
Utility rack GN	481>483	Wok	24, 35, 258, 259
<b>V</b>		Wok brush	262
Vacuum pump wine preserver	324	Wonton noodle skimmer	262
Vegetable cutter	114, 119, 120	Wooden buffet stand	436
Vegetable knife	84	Wooden stand	436
		Zabaione bowl	40
		Zester	88, 92
		Zippered plastic cover	479
		Zucchini corer	86, 91

<b>A</b>		<b>B</b>	
Accessori chafing dish	453>455	Bacchette cinesi	255, 256
Accessori tavola serie ardesia naturale	342, 343	Bacinella carré	191
Acciaino	152	Bacinella conica	108
Accumulatore freddo/caldo	430, 476	Bacinella per gelato	286
Acetato in fogli	201	Bagnomaria	28, 33, 40
Adattatore induzione	110	Bar	297>326
Adattatore per bocchette	186	Barbecue da tavola	46, 360
Affetta formaggio	85, 89	Barca per sushi e sashimi	253
Affetta mozzarella/pomodori	113	Barra magnetica	159
Affetta pomodori	114	Bastardella	40, 108, 110
Affettatrice a gravità	515	Batticarne	161, 162
Affettatrice manuale	163	Benna ribaltabile	492
Affettatrice verticale	516	Bento box	346
Affilacoltelli elettrico	517	Bicchiere miscelatore	308
Affilacoltelli manuale	159	Bicchieri	308>311
Affumicatoio	501	Bicchierini/ciotoline degustazione	335, 336
Affumicatore	315	Bilance	133>135
Ago da cucina	160	Bistecchiera	45
Alzata 2/3 piani	312, 436	Bocchette	180>186
Alzata buffet	410	Bocchette per sifone panna	295
Alzata cromata	411, 432, 433	Bollitore	27
Alzata frutta	415	Bollitore con rubinetto	509
Alzata legno	436	Bollitore uova	498
Alzata torta/dolci	279>283, 415	Bordatore bicchieri	319
Alzata/cesto	413	Borsa isoterma	269, 270
Amuse-bouche	327>338	Boston shaker	307
Anelli per impiattare	112	Bottiglia angostura	316, 317
Anelli per uova	116	Box portaghiaccio	429
Anello distanziatore	104	Box refrigerato	463, 480
Anello per torte	202	Box termico	463, 480
Aperitivo/degustazione set	328, 329	Brasiera	27
Apparecchi elettrici	496>517	Buffet e presentazione	401>439
Apparecchio cottura sottovuoto	510	<b>C</b>	
Apribarattoli	90	Caffetteria	275>284
Apriscatole	86, 91, 123	Caffettiera pressa filtro	350
Apriscatole da banco	125	Campana per alzata torta	281
Apriscatole elettrico	125, 517	Campanella reception	368
Apriuovo	115	Candelabro	365, 366
Arricciaburro	92, 87	Candele led	367, 418
Articoli GLUTEN FREE	518>523	Candeliere	365, 366
Aspirapolvere meccanico	488	Cannello	193
Asta per mestolame	100	Cannoli/cornetti	187
Asta portascontrini	103	Cannucce	302, 303
Aste delimita corsie a nastro estensibile	494	Cannula disosso	151
Attrezzi decoro	120	Caraffa	310, 350, 351
		Caraffa cereali	437
		Caraffa graduata	105
		Caraffa sake	254
		Caraffa termica	349, 350, 439
		Caramellizzatore	192, 515
		Carapina	286
		Carrelli sala	457>464
		Carrello 3 piani	469
		Carrello antipasti	458
		Carrello arrostiti/bolliti	457
		Carrello con maniglione	468
		Carrello convertibile	484
		Carrello di servizio 2/3 piani	482, 483, 487
		Carrello dolci-formaggi	459
		Carrello flambé	457, 458
		Carrello GN	481>483
		Carrello gueridon	457
		Carrello lavapavimenti con strizzatore	490
		Carrello liquori/vini	460
		Carrello per contenitori PPE	476
		Carrello per derrate alimentari	472
		Carrello porta cassette	484
		Carrello porta ghiaccio	478
		Carrello porta piatti	479
		Carrello porta teglie	482, 483
		Carrello portabiancheria	487
		Carrello portapiatti	469
		Carrello portasacco	492
		Carrello Quick Cart	486
		Carrello rifornimento frigobar	483
		Carrello ritiro vassoi universale	481
		Carrello servizio in camera	462, 464
		Carrello trasporto materiali	484
		Carrello vasca	472
		Carta da forno	200
		Cascata champagne	416
		Casseruola Agemono	259
		Casseruola terracotta	261
		Casseruola zabaione	40
		Casseruola zucchero	40
		Cassetto buffet	411
		Catenella di sicurezza per cavalletti	489
		Cavalletto segnalazione	489
		Cavatappi a doppia leva	324
		Cavatappi cameriere	324
		Centrifuga manuale per verdura	111
		Centrifuga spremisucchi	504, 506
		Ceppe	165
		Ceppo portacoltelli	158, 159
		Cesta baguettes	423
		Cesta per friggere	60
		Cestelli bicchieri	466, 467



Cestello per posate	467	Coltello pompelmo	87, 91	Copripiatto	104, 431
Cestino impasto	248	Coltello prosciutto	137, 143	Cornetto cinese	111, 112
Cesto agrumi	312	Coltello salmone	137, 143, 145	Couscoussiera	30
Cesto con supporto filo	426	Coltello torta	151	Crème caramel	205
Cesto frutta	311, 312, 353	Coltello verdure	84	Crepiera	498
Cesto gastronorm	473	Combi mixer/frusta	503	Cucchiaini decorazione	107, 179
Cesto pane	421>427, 473	Combinato cutter/tagliaverdure	505	Cucchiaino assenzio	305
Cesto pane cotone	427	Compressore per penna aerografa	192, 515	Cucchiaino cinesee	254
Cesto pane tavola	353, 354	Contenitore cilindrico	28	Cucchiaino cocktail	92
Cesto uova	427	Contenitore di riserva	318	Cucchiaino finger-food	405
Chitarra	195	Contenitore isotermico	475>478	Cucchiaino miscelatore	304
Ciotola doppia parete	442	Contenitore per alimenti	471, 472	Cucchiaino per spaghetti	100
Ciotola melamina	402>404, 407>411, 431>432	Contenitore per cannuce	289	Cucchiaino riso	257
Ciotola refrigerata	431>432	Contenitore per cialde	289	Cucchiainone	100
Ciotola testa di leone	353	Contenitore per impasti	271	Cucchiainone PA+	79
Ciotola tortillas	48	Contenitore per uova	116	Cucchiainone salse	100
Ciotola vetro	431	Contenitore rifiuti	490, 491	Cucchiainone unipezzo	98, 99
Ciotole/vassoi serie argilla	345, 346	Contenitore salvaspazio	473	Cucina etnica	249>262
Ciotole/vassoi serie nero & marrone	344, 345	Contenitore sovrapponibile	473, 475	Cuoci riso a vapore	508
Clip chiudi sacco	112, 188	Contenitore universale	470	Cuociasparagi	18
Clip flessibili	367, 427	Contenitore versatore	317, 318	Cuocivapore	257, 261
Clip per vasetti Weck	349	Contenitori GN	51>77	Cutter da tavolo	501, 505
Clip reggibicchieri	326	Contenitori GN inox	52>58	<b>D</b>	
Cloche	358	Contenitori GN melamina	72, 73	Decoratore	88
Cloche per affumicatore	316	Contenitori GN PC	61, 62	Densimetro per salamoia	131
Cocotte molluschi	360	Contenitori GN porcellana	74, 75	Densimetro per sciroppo	131
Colafrutto	27, 100	Contenitori GN porcellana induzione	76, 77	Disidratatore	501
Colapasta	108, 109	Contenitori GN PP	67>71	Display per buffet	413, 414
Colapasta a settori	28	Contenitori GN Tritan	63, 64	Distributore di cereali	437>439
Colapasta rinforzato	111	Coperchi ermetici Weck	349	Distributore di latte	438, 439
Colatutto PA+	82	Coperchi GN ermetici con GUARNIZIONE	69	Distributore di succhi	438, 439
Colino	109, 111	Coperchio per ceste pane	425	Distributore panini	420
Colino cocktail	305	Coperchio per ciotole	431	Distributore termico	437
Colino Julep	305	Coperchio roll-top	425, 428>430	Dosa creme	192
Collare salvagoccia	365	Copertura igienica	422	Dosacaffè	92
Colonna luminosa	415	Copertura protettiva	469	Dosatore a leva	106
Colonna portasecchiello	363	Copertura termica	479	Dosatore miele/cremiera	277
Coltelleria	136>158	Copertura vinile	487	<b>E</b>	
Coltelli forgiati	136>138	Coperture monouso	481	Espositore buffet cromato	434, 435
Coltelli sushi giapponesi	155, 156	Coppa ananas	298	Espositore buffet legno	436
Coltelli tranciati	139>147	Coppa burro	352	Espositore caldo ventilato	500
Coltello apriostriche	84, 90, 150	Coppa caviale	362	Espositore cereali	437
Coltello bar	87	Coppa gelato	290>292	Espositore frutta	433, 434
Coltello bistecca	138, 145, 146	Coppa martini/margarita	298	Espositore marmellate	437
Coltello castagne	84	Coppa punch	416	Espositore per bocchette	189
Coltello formaggio	151	Coppa riso	250, 252	Espositore per cereali	437
Coltello ghiaccio	121	Coppa soufflè	44, 48	Espositore per sacchetti	189
Coltello grana	84, 89, 150	Coppa zucca	298	Espositore per vetrina gelato	294
Coltello pane	138, 147	Coppetta sake	254		
Coltello per marzapane	179	Coppette melamina	335		

Espositore sacchetti/bocchette	189	GN bacinelle antiaderenti	55	Levatorboli	88, 91
Etichette allergeni	132, 133	GN bacinelle forate	56	Lira per formaggi	118
Etichette identificazione x cestelli	467	GN bacinelle, maniglie fisse	53, 54	Lira per pan di Spagna	195
<b>F</b>		GN bacinelle, maniglie interne	54	<b>M</b>	
Falcetta cinese	149	GN bacinelle, maniglie rientranti	55	Macchina per cialde	501, 502
Falcetta macellaio	149, 150	GN coperchi	57	Macchina per gelato	500
Falcetta prezzemolo	84	GN coperchi ermetici	64	Macchina per raclette	359, 513
Falso fondo forato	60	GN coperchio con guarnizione silicone	62	Macina erbe/peperoncino	383
Fascia microforata	203	GN-teglie	58, 59	Macina noce moscata	383, 384
Fasciatoio	486	Grattugia	85, 90, 117, 118, 122, 123	Macina pepe/sale PEUGEOT	374>385
Ferma prosciutto	162	Grattugia noce moscata	123	Macinaerbe	124
Fermatovaglia	358	Grattugia per spatzle	123	Mandolino	118, 119
Fingerfood porcellana	337, 338	Grattugia per wasabi	261	Manico per mop	488
Flacone dosatore	106, 107	Grembiule barman	320	Manico telescopico	489
Flacone nebulizzatore	199	Grembiule di protezione	166	Mantecatore per burro	121
Flacone per bagne	199	Griglia di colaggio	190	Marcatore pane Kaiser	248
Flair bottle	315	Griglia Dim Sum	259	Mascherine per cacao	276
Flexipan teglie silicone	232>247	Griglia in filo	60	Mestolo	100
Flute champagne	298	Griglia kebab/gyros	498	Mestolo PA+	80, 81
Fontana cioccolato	415, 513	Griglia per tempura	259	Mestolo unipezzo	98, 99
Fontana cocktails	415	Griglia reversibile	46	Mezzaluna	151
Forbice	153, 154	Griglia a contatto	496	Miscelatori cocktail	303, 304
Forbice per erbe	117	Guanti in lattice	167	Misurino cocktail	305
Forbice sigari	370	Guanti scrub	167	Mixer	503, 504
Forchetta lumache	400	Guanto anti taglio	167	Molla ghiaccio	315, 398
Forchette fonduta	359	Guanto da forno	166, 167	Molla lumache	398
Forchettina ostriche	399	Guanto in cotta di maglia	166	Molla PA+	80
Forchettina patate	91	Guarnizioni Weck	349	Molla pane	397
Forchettine aragosta	361	<b>I</b>		Molla per asparagi	398
Forchettine lumache	361	Imbuto	105	Molla spaghetti	397
Forchettine pralineria	179	Imbuto colatore	191	Molla zucchero	398
Forchettone	100, 138, 151	Impastatrice planetaria	509	Molle e forbici a servire serie Living	397>400
Forchettone unipezzo	98, 99	Insaccatrice verticale	163	Monouso forchettine & cucchiaini	326
Formaggiera	357	Insalatiera	353	Mop	488, 489
Forno microonde	509	Insalatiera melamina	402	Mortaio e pestello	261
Forno multifunzione	499	<b>K</b>		Multi-distributore	435, 436
Friggitrice	499	Kit di infusione rapida	296	<b>N</b>	
Frullatore	507	<b>L</b>		Nastro per dolci	201
Frullino	508	Laccetti da cucina	113	Nebulizzatore olio/acetato	356
Frusta	100, 103	Lame panettiere usa e getta	248	Noccioli di cottura	201
Frusta PA+	82	Lampada ad infrarossi	502	<b>O</b>	
<b>G</b>		Lampada per zucchero	193, 514	Oliera	261, 264
Ganci	160, 161	Lanterne	418	Omogeneizzatore	505
Gancio appendi borsa	363	Lattiera cappuccino	277	Orologio da parete	133
Gel combustibile	455	Lattiera con coperchio	277	<b>P</b>	
Gelateria	285>296	Lavagna	368	Padella balti/karahi	260
Girello	189	Legatovagliolo	358	Padella blini	33, 35, 42
Glacette termica	363, 364	Levacapsule	86, 91, 325		

Padella crêpes	32, 33	Pentolame serie 2500 3-ply	23>25	Porta posate	467, 468
Padella Tamagoyaki	260	Pentolame serie 6100 alluminio	29>33	Porta rotolo	104, 481
Padella Tawa	260	Pentolame serie Gluten Free inox	21, 518, 519	Porta snack	327, 328
Padella Toban	259	Percolatore per caffè	451, 511	Portabustine zucchero	278
Padelle ferro	34, 35	Pesa sciropo (densimetro)	194	Portacandela	366
Pala ghiaccio	478	Pesciera	27, 33, 40	Portaciotole cromato	431, 433
Pala per patate fritte	101	Pestaghiaccio	313	Portacombustibile	455
Pala pizza	264>267	Pettini decoratori	198	Portacondimenti	319, 357
Pala torta	96, 189	Piano caldo	503	Portagiornale	368
Pala torta	398	Piastra ad induzione	453, 511	Portaposate	357, 430
Paletta forata	100	Piastre elettriche	455	Portarifiuti da tavola	361
Paletta unipezzo	99	Piattino fingerfood	403	Portaspago	162
Palette PA+	79>81	Piatto fingerfood	415	Portataglieri	166
Pallet	493	Piatto lumache	361	Portatoast	352
Panno in microfibra	489	Piatto melamina	404, 406, 410	Portatovaglioli	278, 279, 288
Panno passabrodo	112	Piatto torta/formaggi	409	Portauovo	352
Passapomodoro	124	Pietanziera	478	Porzionatore	91, 112, 287
Passathé	352	Pietra per affilare	152	Posacenera	369, 370
Passaverdura	111, 124	Pinza	304	Posacenera a colonna	493
Passaverdura elettrico	517	Pinza a servire	102	Posate caviale	362
Pasticceria	168>248	Pinza aragosta	361	Pressa bottiglie e lattine	125
Pattumiera	488	Pinza champagne	365	Pressa hamburger	163
Pattumiera a pedale	492	Pinza da cucina	102, 103	Pressapatate	90
Pedana	493	Pinza per affettati	161	Pressapolipo	113
Pela asparagi	86	Pinza per anatra	262	Presse-canard	113
Pela mele	115	Pinza per mop	489	Pungisalame	159
Pela pomodori	87	Pinza per teglie	267	Raccoglibriciole	358
Pela/svuota ananas	114	Pinza togli lisce	102	Raschia per pasta	271
Pela/taglia avocado	116	Pirofila ovale melamina	405	<b>R</b>	
Pelapatate	87, 91, 117	Pirofile forno	50	Raschietti	198
Pelarence	87, 91	Pirofile forno APPOLIA PEUGEOT	388>395	Rastelliera per teglie	272
Pelatrice elettrica	115, 501	Pistola elettrica	192, 514	Rastrelliera	103, 321
Penna a gesso liquido	287, 368, 427	Pizza	263>274	Rechaud	360
Penna aerografa	192	Pizzi sottotorta	189	Retina pizza	272
Pennello	85, 90, 198	Plancia melamina	408	Ricambi	524>532
Pennello per wok	262	Pompa sottovuoto per vino	324	Ricariche panna montata	296
Pentola cinese	260	Pompetta con terminale in rame	193	Ricariche soda	313
Pentola per riso dolce	258	Pompetta per sugo	102	Riga	194
Pentolame	10>48	Ponte per sushi/sashimi	252	Rigalimoni	88, 92
Pentolame ghisa smaltata	43>48	Porta Brezel	422	Riscalda sake	254
Pentolame serie 1000 inox	14>16	Porta cannuce	278	Rompighiaccio	313
Pentolame serie 1100 inox	10>12	Porta coni	288>290	Rotella taglia pasta	84, 88, 196
Pentolame serie 12300 3-ply	441	Porta coppette	334	Rotella taglia pizza	84, 88, 267
Pentolame serie 12300 3-ply	441	Porta cucchiaini	277	Rotolo portacoltelli	158
Pentolame serie 15200 rame 3-ply miniature	38	Porta menù	367	Rouet	120
Pentolame serie 15300-15400 rame stagnato	39, 40	Porta oggetti da bar	315	Rullo	197
Pentolame serie 15500 rame 3-ply induzione	36, 37	Porta pale	266	Rullo bucasfoglia	196
Pentolame serie 16130 alluminio miniature	41	Porta palette e coppette	289	Runner	341
Pentolame serie 2000 inox	17>19	Porta piatti in filo	467		
Pentolame serie 2100 inox	13	Porta piatti rotante	477		

<b>S</b>					
Sacchetto per decorare	187, 188	Sessola	107	Stampo mooncake	256
Sacco vinile	487	Sessola per ghiaccio	313	Stampo panzerotti	123
Salamandra	497	Set fonduta	40, 359	Stampo per burro	121
Salinometro	131	Setacci	107, 199	Stampo per nigiri	257
Salsiera	253, 352	Sgocciolatore	231	Stampo scanalato	40
Samovar	450, 451, 512	Shaker	306, 307	Stampo uovo	224
Saponetta togli odori	92	Sifone nitro	276	Stand per vassoi	418
Sbuccia melone	87	Sifone panna	295	Stencils	216
Scalda würstel	498	Sifone soda	313	Stendipasta	194
Scaldacaffè	450	Siringa per marinata	102	Sterilizzatore coltelli	159, 517
Scaldacognac	365	Siringa per pasticceria	188	Stiletto aragosta	361
Scaldapiatti	500	Sistema di pulizia, kit Pulse	488	Stiletto tailandese	120
Scaldavivande	444>449	Snocciolatore	118	Stoccaggio, trasporto, pulizia	466>494
Scaletta pieghevole	493	Sottopentola	44, 360	Strisce reattive per oli di frittura	131
Scalpellino ghiaccio	121	Spaccaghiaccio elettrico	507	Stuoietta	257
Scatola bento	252	Spalmaburro	85, 90	Stuzzicadenti	326
Scatola buffet acacia	420, 421	Spargi cacao	277	Supporto bacchette cinesi	255
Scatola portabustine thè	278	Spargi formaggio	357	Supporto bottiglie	321, 322
Scavino	86, 91	Spargisale/pepe	355	Supporto buffet in filo	426, 427
Schiaccianoci	361	Spargizucchero	199, 277	Supporto casseruolina	44
Schiacciapatate	117	Spatola crêpe	101	Supporto con pietra ollare	359
Schiumarola	100, 101	Spatola gelato	286	Supporto cromato	402, 432
Schiumarola fritto	262	Spatola in resina alimentare	103	Supporto murale porta pellicola	104
Schiumarola PA+	80, 81	Spatole	95, 96	Supporto numero tavola	367
Schiumarola unipezzo	99, 100	Spatole PA+	79	Supporto per temaki	252
Schiumarola Wonton	262	Spazzola grill	103	Supporto secchio vino tavola	363
Sciabola per Sommelier	365	Spazzola orientabile	265	Supporto targhetta	367
Scolapiatti a muro	469	Spazzola pane	248	Supporto vasetti Weck	349
Scopa a forcice	488	Spazzola per farina	199	Supporto vassoio frutti di mare	362
Scopa c/alza immondizia	488	Spazzole lavabicchieri	321	Svuota ananas	86
Scopa spingiacqua	488	Specchi	417	Svuota carciofi	116
Secchio con strizzatore	490	Spelucchino	89, 138, 146	Svuota zucchine	86, 91
Secchio ghiaccio	315, 478	Spiedini	160, 256, 325, 326		
Secchio graduato	109, 490	Spillone portascontrini	103	<b>T</b>	
Secchio portabottiglie	414	Spremiaglio	90, 118	Taglia ananas	115
Secchio vino	363	Spremiagrumi elettrico	506>508	Taglia capsula	324
Sega per ossa	162	Spremiagrumi manuale	312	Taglia cavolini di Bruxelles	116
Segatura aromatizzata	316	Spremilimone	312	Taglia croissants	196
Seggiolone	486	Squamapesce	84, 85, 88, 262	Taglia cubi	114
Segnagusto	287, 288	Stampi bigné	245, 246	Taglia funghi	116
Segnalatore telescopico di sicurezza	490	Stampi ghiaccio	314	Taglia pane	421
Segnaporzioni	197	Stampi in policarbonato per praline	217>223	Taglia patate	117
Senapiera	352	Stampi in silicone per praline	216	Taglia ricci di mare	361
Separatore	60	Stampi Natale policarbonato	225	Taglia tortillas	117
Separauova	92	Stampi Pasqua policarbonato	225	Taglia uova	115
Servitartufi	355	Stampi per pane	246, 247	Taglia verdure	114, 119, 120
Servizio caffè	280	Stampi silicone	226>231	Tagliapasta	271
Servizio olera	356, 357	Stampi tavolette cioccolato	223	Tagliapasta con espulsore	178, 179
		Stampo cucchiaino	223	Tagliapasta estensibile	196
		Stampo gelato	293, 294	Tagliapasta inox	169>177



Tagliapasta PA+	178	Tritaghiaccio elettrico	508
Tagliasisigari da tavola	369	Tritaghiaccio manuale	313
Tagliatartufi	355	Tronchetto tagliapizza	267
Tagliaverdure elettrico	504	<b>U</b>	
Tagliere HDPE	164, 165	Utensili cucina PA+	79>82
Tagliere melamina	408	Utensili da cucina	78>135
Tagliere pane	166, 411, 421, 429>430	<b>V</b>	
Tagliere sushi	252	Valigetta cameriere	325
Taglieri da portata	330>334	Valigia Barman	320
Tampone finto legno	214	Valigia cuoco	157
Tappeto silicene	200, 201	Vaporiera	509
Tappeto sottobicchieri	319	Vasca riso hangiri	258
Tappo dosatore	323	Vasetti Weck	347, 348, 349
Tappo dosatore automatico	322	Vaso fiori	365
Tappo spumante	323	Vaso porta sacchetto	189
Tappo versatore	317, 322	Vaso soia	254
Tappo vino	323	Vassoi & ciotole melamina serie Thara	250, 251
Targhetta tavola	367	Vassoi inox	418, 419
Tartellette	211, 212	Vassoi melamina	403, 404, 407, 410
Tastevin	365	Vassoio carni	162
Tavola	339>370	Vassoio colazione con gambe	461
Tavolino con box termico	480, 503	Vassoio con campana	355
Tavolino room service	463, 464	Vassoio conto	279
Tazza julep	300, 301	Vassoio espositore	199, 200
Tazza moscow mule	298>300	Vassoio fast food	480, 481
Tegame	27	Vassoio frutti di mare	362
Tegamino uova	50	Vassoio portatovagliolo	252
Teglia forno	272>274	Vassoio room service	461
Teglia pizza	272, 273	Versatore	365
Teglie	190, 191	Versavino	364
Teglie GN alluminio/antiaderenti	58	Vetrina da banco	283, 284
Teiera	254, 255	Vetrina refrigerata	429, 430
Telai per dolci	204, 205	Vetrina riscaldata	500
Telaio per ganache	195	Vetrina set buffet	428, 429
Telaio pieghevole	486	Vetrina sigari	370
Temperatrice	193, 294, 295, 514	<b>W</b>	
Temperino per verdure	85	Wok	24, 35, 258, 259
Termoigrometro	131	<b>Z</b>	
Termometri	126>132	Zuppiera elettrica	452, 513
Termoregolatore	455		
Tester per oli di frittura	132		
Tiki mug	301, 302		
Timer digitale	131		
Tortiere alluminio	206		
Tortiere antiaderenti	209>211, 213, 214		
Tostapane	496		
Tovaglietta	341		
Trancia spicchi	114, 115		
Trinciapollo	152		
Tritacarne elettrico	515		

**NUMERICAL INDEX**

**INDICE NUMERICO**

**NUMERISCH INDEX**

**INDEX NUMERIQUE**

**INDICE NUMERICO**

**NUMERICAL INDEX INDICE NUMERICO NUMERISCH INDEX INDEX NUMERIQUE INDICE NUMERICO**

Cod.	pag.	Cod.	pag.	Cod.	pag.	Cod.	pag.	Cod.	pag.	Cod.	pag.	Cod.	pag.
11001-16	15	11009-36	15	11101-32	11	11109-40	11	11161-32	12	11714-45	35	11742-18	273
11001-18	15	11009-40	15	11101-36	11	11109-45	11	11161-36	12	11714-50	35	11742-20	273
11001-20	15	11009-45	15	11101-40	11	11109-50	11	11161-40	12	11715-12	35	11742-22	273
11001-22	15	11009-50	15	11101-45	11	11112-16	12	11161-45	12	11716-16	35	11742-24	273
11001-24	15	11009-60	15	11101-50	11	11112-18	12	11161-50	12	11716-20	35	11742-26	273
11001-28	15	11010-16	15	11102-28	11	11112-20	12	11161-60	12	11716-22	35	11742-28	273
11001-32	15	11010-18	15	11102-32	11	11112-24	12	11161F16	21	11716-24	35	11742-30	273
11001-36	15	11010-20	15	11102-36	11	11113-18	12	11161F20	21	11716-26	35	11742-32	273
11001-40	15	11010-24	15	11102-40	11	11113-20	12	11161F24	21	11716-28	35	11742-36	273
11001-45	15	11011-16	16	11102-45	11	11113-24	12	11161F28	21	11716-32	35	11742-40	273
11001-50	15	11011-18	16	11102-50	11	11113-26	12	11617-20	32	11716-36	35	11742-45	273
11001-60	15	11011-20	16	11102-99	524	11114-20	12	11617-24	32	11716-40	35	11742-50	273
11006-12	16	11011-24	16	11105-16	11	11114-24	12	11617-28	32	11716-45	35	11742-60	273
11006-14	16	11012-16	15	11105-20	11	11114-28	12	11617-32	32	11717-34	35	11744-20	272
11006-16	16	11012-18	15	11105-24	11	11114-32	12	11701-02	264	11717-37	35	11744-24	272
11006-18	16	11012-20	15	11105-28	11	11114-36	12	11701-06	264	11717-42	35	11744-28	272
11006-20	16	11012-24	15	11105-32	11	11114-40	12	11701-10	264	11717-47	35	11744-32	272
11006-22	16	11013-18	15	11105-36	11	11114-45	12	11701-13	264	11718-20	35	11750-11	60
11006-24	16	11013-20	15	11105-40	11	11115-20	12	11701-16	264	11718-22	35	11760-11	60
11006-28	16	11013-24	15	11106-14	11	11115-24	12	11702-02	264	11718-24	35	11910-12	28
11006-32	16	11013-26	15	11106-16	11	11115-28	12	11702-06	264	11721-28	35	11910-14	28
11006-36	16	11014-20	16	11106-20	11	11115-32	12	11702-10	264	11739-20	272	11910-16	28
11007-16	15	11014-24	16	11106-24	11	11115-36	12	11702-16	264	11739-24	272	11910-18	28
11007-18	15	11014-28	16	11106-28	11	11115-40	12	11704-02	264	11739-28	272	11910-20	28
11007-20	15	11014-32	16	11106-32	11	11115-45	12	11704-06	264	11739-32	272	11911-12	28
11007-22	15	11014-36	16	11106-36	11	11115-50	12	11704-13	264	11739F20	518	11911-14	28
11007-24	15	11014-40	16	11107-16	11	11117-20	12	11704-16	264	11739F24	518	11911-16	28
11007-28	15	11014F20	21	11107-20	11	11117-24	12	11705-02	264	11739F28	518	11911-18	28
11007-32	15	11014F24	21	11107-24	11	11117-28	12	11705-06	264	11739F32	518	11911-20	28
11007-36	15	11014F28	21	11107-28	11	11117-32	12	11705-10	264	11740-14	273	11913-16	28
11007-40	15	11014F32	21	11107-32	11	11117-36	12	11705-14	264	11740-16	273	11913-20	28
11007-45	15	11061-12	16	11107-36	11	11117-40	12	11706-02	264	11740-18	273	11913-24	28
11007-50	15	11061-16	16	11107-40	11	11119-20	11	11706-06	264	11740-20	273	11913-28	28
11007-60	15	11061-18	16	11107-45	11	11119-24	11	11706-10	264	11740-22	273	11922-36	28
11008-16	16	11061-20	16	11107-50	11	11119-28	11	11706-14	264	11740-24	273	11922-40	28
11008-18	16	11061-22	16	11108-16	12	11119-32	11	11710-AA	35	11740-26	273	11924-18	109
11008-20	16	11061-24	16	11108-20	12	11123-20	11	11710-AB	35	11740-28	273	11924-20	109
11008-24	16	11061-28	16	11108-24	12	11123-24	11	11713-32	35	11740-30	273	11924-22	109
11008-28	16	11061-32	16	11108-28	12	11123-28	11	11713-40	35	11740-32	273	11924-24	109
11008-32	16	11061-36	16	11108-32	12	11161-12	12	11714-20	35	11740-36	273	11924-28	109
11008-36	16	11061-40	16	11108-36	12	11161-14	12	11714-22	35	11740-40	273	11924F20	21
11009-16	15	11061-45	16	11109-16	11	11161-16	12	11714-24	35	11741-20	272	11926-22	109
11009-18	15	11061-50	16	11109-20	11	11161-18	12	11714-26	35	11741-24	272	11926-26	109
11009-20	15	11101-16	11	11109-24	11	11161-20	12	11714-28	35	11741-26	272	11927-24	108
11009-24	15	11101-20	11	11109-28	11	11161-22	12	11714-32	35	11741-28	272	11927-28	108
11009-28	15	11101-24	11	11109-32	11	11161-24	12	11714-36	35	11741-32	272	11927-32	108
11009-32	15	11101-28	11	11109-36	11	11161-28	12	11714-40	35	11742-16	273	11927-36	108

Cod.	pag.	Cod.	pag.	Cod.	pag.	Cod.	pag.	Cod.	pag.	Cod.	pag.	Cod.	pag.
11927-40	108	11952-40	110	11970-10	98	12001-28	18	12107-20	13	12303W24	441	12550-09	400
11927-45	108	11953-16	110	11970-11	98	12001-32	18	12107-24	13	12303Y16	441	12550-11	398
11927-50	108	11953-22	110	11970-12	98	12001-36	18	12107-28	13	12303Y20	441	12550-12	398
11928-32	108	11954-26	110	11970-14	98	12001-40	18	12107-32	13	12303Y24	441	12550-13	398
11928-36	108	11954-30	110	11970-16	98	12001-45	18	12107-36	13	12304B26	441	12550-14	398
11928-40	108	11954-32	110	11970F06	519	12001-50	18	12107-40	13	12304G26	441	12550-15	399
11929-20	112	11954-36	110	11970F08	519	12001-60	18	12107-45	13	12304O26	441	12550-16	399
11929-24	112	11954-37	110	11970F10	519	12001F20	21	12107-50	13	12304W26	441	12550-17	399
11930-24	108	11954-40	110	11971-01	100	12001F24	21	12109-16	13	12304Y26	441	12550-19	400
11930-28	108	11955-32	108	11971-08	99	12001F28	21	12109-20	13	12504-20	103	12550-20	399
11930-32	108	11955-36	108	11971-10	99	12007-16	18	12109-24	13	12507-24	24	12550-21	399
11930-36	108	11955-40	108	11971-12	99	12007-18	18	12109-28	13	12507-28	24	12550-22	398
11930-40	108	11955-45	108	11971-14	99	12007-20	18	12109-32	13	12508-24	24	12550-25	399
11930-45	108	11955-50	108	11971-16	99	12007-22	18	12109-36	13	12509-12	25	12550-26	399
11930-50	108	11956-37	416	11971-18	99	12007-24	18	12109-40	13	12509-20	24	12550-30	399
11930F24	21	11956-42	416	11971-20	99	12007-28	18	12109-45	13	12509-24	24	12550-33	399
11932-20	112	11957-20	108	11971-25	99	12007-32	18	12109-50	13	12509-28	24	12550-34	398
11932-24	112	11957-25	108	11971F10	519	12007-36	18	12119-20	18	12511-10	25	12550-36	399
11941-35	27	11957-30	108	11971F12	519	12007-40	18	12119-24	18	12511-12	25	12550-43	399
11941-40	27	11957-35	108	11972-10	99	12007-45	18	12119-28	18	12511-14	25	12550-50	397
11941-45	27	11957-40	108	11972-12	99	12007-50	18	12119-32	18	12511-16	24	12550-53	398
11941-50	27	11965-50	27	11973-01	99	12007-60	18	12123F20	21	12511-18	24	12550-54	398
11941-60	27	11965-60	27	11973-10	99	12007F16	21	12123F24	21	12511-20	24	12550-55	398
11943-40	27	11965-61	27	11973-12	99	12007F24	21	12123F28	21	12511-24	24	12550-56	398
11943-45	27	11966-50	524	11973F10	519	12007F28	21	12300-18	442	12513-16	24	12550-58	397
11943-50	27	11966-60	524	11973F12	519	12009-16	18	12300-24	442	12513-18	24	12550-60	398
11943-60	27	11966-61	524	11974-50	98	12009-18	18	12300B18	442	12513-20	24	12550-62	397
11943-61	27	11967-06	98	11974-70	98	12009-20	18	12300B24	442	12513-24	24	12550-63	397
11944-40	27	11967-08	98	11975-01	99	12009-24	18	12300G18	442	12514-20	25	12550-64	397
11944-45	27	11967-09	98	11975-50	99	12009-28	18	12300G24	442	12514-24	24	12550-66	398
11944-50	27	11967-10	98	11975-99	99	12009-32	18	12300O18	442	12514-26	24	12550-68	397
11944-60	27	11967-12	98	11976-50	99	12009-36	18	12300O24	442	12514-28	24	12550-69	397
11944-61	27	11967-14	98	11976-99	99	12009-40	18	12300W18	442	12514-32	24	12550-70	397
11948-40	27	11967-16	98	11982-01	99	12009-45	18	12300W24	442	12514-36	24	12550-73	397
11948-45	27	11967-18	98	11982-38	98	12009-50	18	12300Y18	442	12517-24	24	12550-74	397
11948-50	27	11967-20	98	11982F38	519	12009-60	18	12300Y24	442	12517-26	24	12550-77	397
11948-60	27	11967-24	98	11983-37	98	12037-16	18	12303B16	441	12517-28	24	12550-78	397
11948-61	27	11968-18	98	11983-38	98	12101-16	13	12303B20	441	12517-32	24	12550-80	397
11951-22	110	11968-20	98	11984-38	98	12101-20	13	12303B24	441	12517-36	24	12550-81	397
11951-26	110	11968-24	98	11985-34	99	12101-24	13	12303G16	441	12529-32	24	12550-83	397
11951-32	110	11969-02	99	11990-16	100	12101-28	13	12303G20	441	12550-01	399	12550-84	397
11951-36	110	11969-06	98	11991-16	100	12101-32	13	12303G24	441	12550-02	398	12550-85	397
11951-40	110	11969-37	98	12001-16	18	12101-36	13	12303O16	441	12550-03	400	12550-87	397
11952-22	110	11970-01	99	12001-18	18	12101-40	13	12303O20	441	12550-04	313	12550-88	397
11952-26	110	11970-06	98	12001-20	18	12101-45	13	12303O24	441	12550-05	400	12550-89	397
11952-32	110	11970-08	98	12001-22	18	12101-50	13	12303W16	441	12550-06	400	12561-12	25
11952-36	110	11970-09	98	12001-24	18	12107-16	13	12303W20	441	12550-07	400	12561-16	25



**NUMERICAL INDEX INDICE NUMERICO NUMERISCH INDEX INDEX NUMERIQUE INDICE NUMERICO**

Cod.	pag.	Cod.	pag.	Cod.	pag.	Cod.	pag.	Cod.	pag.	Cod.	pag.	Cod.	pag.
12561-18	25	12633-16	111	12917-25	79	12940-20	107	14007-00	467	14105-20	53	14119-10	54
12561-20	25	12633-18	111	12920-01	80	12940-25	107	14008-00	467	14105F02	520	14119-15	54
12561-24	25	12633-20	111	12920-05	80	12941-07	82	14010-00	467	14105F04	520	14142-10	54
12561-26	25	12633-23	111	12920-10	80	12941-10	82	14011-00	467	14105F06	520	14142-15	54
12561-28	25	12633-26	111	12920-11	80	12941-12	82	14013-00	467	14105F10	520	14142-20	54
12580-11	108	12635-23	111	12920-15	80	12941-14	82	14015-08	467	14105F15	520	14145-10	54
12580-17	108	12635-26	111	12920-16	80	12941-16	82	14101-02	52	14105F20	520	14145-15	54
12580-21	108	12635-30	111	12921-01	79	12941-18	82	14101-04	52	14107-06	53	14145-20	54
12580-24	108	12635-35	111	12921-05	79	12941-20	82	14101-06	52	14107-10	53	14147-10	54
12580-29	108	12636-32	111	12921-10	79	12941-23	82	14101-10	52	14107-15	53	14147-15	54
12580-30	108	12638-20	111	12921-15	80	12941-26	82	14101-15	52	14107-20	53	14147-20	54
12580-31	108	12640-14	101	12926-35	82	12943-13	112	14101-20	52	14107F06	520	14148-10	54
12580-36	108	12640-16	101	12927-35	82	12944-13	112	14102-02	52	14107F10	520	14148-15	54
12580-40	108	12640-18	101	12927-45	82	12947-13	178	14102-04	52	14107F15	520	14148-20	54
12580-45	108	12640-20	101	12928-25	82	12950-32	82	14102-06	52	14107F20	520	14151-10	55
12580-50	108	12640-24	101	12928-30	82	12950-40	82	14102-10	52	14108-06	53	14151-15	55
12582-13	108	12640-28	101	12928-35	82	12967-06	81	14102-15	52	14108-10	53	14151-20	55
12582-17	108	12641-14	101	12928-40	82	12967-10	81	14102-20	52	14108-15	53	14152-06	55
12582-22	108	12641-16	101	12928-45	82	12968-10	81	14102F02	520	14108-20	53	14152-10	55
12582-24	108	12641-18	101	12928-50	82	12969-06	81	14102F04	520	14108F06	520	14152-15	55
12582-32	108	12641-20	101	12928-55	82	12969-10	81	14102F06	520	14108F10	520	14152-20	55
12582-34	108	12641-24	101	12928-60	82	12970-06	81	14102F10	520	14108F15	520	14155-10	55
12582-38	108	12641-28	101	12928F30	519	12970-08	81	14102F15	520	14108F20	520	14155-15	55
12582-40	108	12642-28	101	12928F35	519	12970-10	81	14102F20	520	14109-06	53	14155-20	55
12604-22	107	12903-30	79	12929-25	82	12970-12	81	14103-02	53	14109-10	53	14157-10	55
12604-30	107	12903-40	79	12929-30	82	12971-10	81	14103-04	53	14109-15	53	14157-15	55
12604-34	107	12903-45	79	12929-35	82	12971-12	81	14103-06	53	14109-20	53	14157-20	55
12604-40	107	12905-25	79	12929-40	82	12972-10	81	14103-10	53	14109F06	520	14158-10	55
12605-22	107	12905-30	79	12929-45	82	12972-12	81	14103-15	53	14109F10	520	14158-15	55
12605-30	107	12905-35	79	12929F30	520	12973-10	81	14103-20	53	14109F15	520	14158-20	55
12605-34	107	12905-40	79	12929F35	520	12973-12	81	14103F02	520	14109F20	520	14159-10	55
12605-40	107	12905-45	79	12930-51	80	12986-01	81	14103F04	520	14110-06	53	14159-15	55
12606-30	107	12905-50	79	12930-52	80	12986-38	81	14103F06	520	14110-10	53	14159-20	55
12606-34	107	12906-35	79	12930-62	80	12992-36	28	14103F10	520	14110F06	520	14162-02	55
12607-22	107	12907-07	79	12930-63	80	12992-40	28	14103F15	520	14110F10	520	14162-04	55
12607-30	107	12907-08	79	12930-68	80	14001-09	466	14103F20	520	14112-10	53	14162-06	55
12607-34	107	12908-30	79	12930-69	80	14001-16	466	14104-06	53	14112-15	53	14165-02	55
12622-07	111	12908-35	79	12930-74	80	14001-25	466	14104-10	53	14112-20	53	14165-04	55
12622-10	111	12908-40	79	12930-77	80	14001-36	466	14104-15	53	14115-10	54	14165-06	55
12622-12	111	12909-12	79	12930-78	80	14001-49	466	14104F06	520	14115-15	54	14201-02	56
12622-14	111	12909-23	79	12931-51	81	14003-09	466	14104F10	520	14115-20	54	14201-04	56
12622-16	111	12915-25	79	12931-53	81	14003-16	466	14104F15	520	14117-10	54	14201-06	56
12622-18	111	12915-26	79	12932-22	82	14003-25	466	14105-02	53	14117-15	54	14201-10	56
12622-20	111	12915-35	79	12932-26	82	14003-36	466	14105-04	53	14117-20	54	14201-15	56
12622-23	111	12915-45	79	12940-02	107	14003-49	467	14105-06	53	14118-10	54	14201-20	56
12622-26	111	12916-25	79	12940-05	107	14004-00	467	14105-10	53	14118-15	54	14202-02	56
12630-22	111	12916-33	79	12940-10	107	14006-00	467	14105-15	53	14118-20	54	14202-04	56

Cod.	pag.	Cod.	pag.	Cod.	pag.	Cod.	pag.	Cod.	pag.	Cod.	pag.	Cod.	pag.
14202-06	56	14502F00	520	14565-15	61	14669-06	64	14718-00	66	14927-11	70	15108-10	22
14202-10	56	14503-00	57	14565-20	61	14669-10	64	14719-00	66	14927-22	70	15108-15	69
14202-15	56	14503F00	520	14567-06	62	14669-15	64	14722-00	67	14927-33	70	15108-20	69
14202-20	56	14504-00	57	14567-10	62	14669-20	64	14722-11	67	14927-77	22	15109-06	69
14203-06	56	14504F00	520	14567-15	62	14670-06	64	14722-22	67	14927-99	70	15109-10	22
14203-10	56	14505-00	57	14567-20	62	14670-10	64	14722-33	67	14928-00	70	15109-15	69
14203-15	56	14505F00	520	14568-06	62	14671-00	64	14722-99	67	14928-11	70	15109-20	69
14203-20	56	14507-00	57	14568-10	62	14672-00	64	14725-00	67	14928-22	70	15110-06	69
14205-02	56	14507F00	520	14568-15	62	14675-00	64	14725-11	67	14928-33	70	15110-10	22
14205-04	56	14508-00	57	14568-20	62	14677-00	64	14725-22	67	14928-77	22	15224-10	38
14205-06	56	14508F00	520	14569-06	62	14678-00	64	14725-33	67	14928-99	70	15224-12	38
14205-10	56	14509-00	57	14569-10	62	14679-00	64	14725-99	67	14929-00	70	15224-14	38
14205-15	56	14509F00	520	14569-15	62	14680-00	64	14727-00	67	14929-11	70	15225-10	38
14205-20	56	14510-00	57	14569-20	62	14682-00	64	14727-11	67	14929-22	70	15225-12	38
14252-06	56	14510F00	520	14570-06	62	14685-00	64	14727-22	67	14929-33	70	15225-14	38
14252-10	56	14512-00	57	14570-10	62	14687-00	64	14727-33	67	14929-77	22	15226-07	38
14252-15	56	14515-00	57	14571-00	62	14688-00	64	14727-99	67	14929-99	70	15226-10	38
14252-20	56	14517-00	57	14572-00	62	14689-00	64	14728-00	67	14930-00	70	15226-12	38
14255-06	56	14518-00	57	14575-00	62	14690-00	64	14728-11	67	14930-11	70	15226-14	38
14255-10	56	14519-00	57	14577-00	62	14691-00	64	14728-22	67	14930-22	70	15227-10	38
14255-15	56	14522-00	57	14578-00	62	14692-00	64	14728-33	67	14930-33	70	15227-12	38
14255-20	56	14523-00	57	14579-00	62	14695-00	64	14728-99	67	14930-77	22	15227-14	38
14301-02	58	14525-00	57	14580-00	62	14702-06	66	14729-00	67	14930-99	70	15228-10	38
14301-04	58	14527-00	57	14585-00	62	14702-10	66	14729-11	67	14942-99	69	15229-10	38
14301-06	58	14528-00	57	14591-00	62	14702-15	66	14729-22	67	14945-99	69	15261-10	38
14302-02	58	14529-00	57	14592-00	62	14702-20	66	14729-33	67	14947-99	69	15261-12	38
14302-04	58	14532-00	57	14595-00	62	14705-06	66	14729-99	67	14958-01	313	15261-14	38
14302-06	58	14535-00	57	14597-00	62	14705-10	66	14730-00	67	14958-02	313	15338-38	40
14303-02	58	14537-00	57	14598-00	62	14705-15	66	14730-11	67	15100-01	71	15339-36	40
14303-04	58	14538-00	57	14599-00	62	14705-20	66	14730-22	67	15100-02	71	15343-36	40
14303-06	58	14539-00	57	14661-20	63	14707-06	66	14730-33	67	15100-03	71	15401-51	40
14305-02	58	14542-00	57	14662-06	63	14707-10	66	14730-99	67	15100-04	71	15403-16	40
14305-04	58	14543-00	57	14662-10	63	14707-15	66	14912-00	69	15100-07	71	15406-16	40
14305-06	58	14545-00	57	14662-15	63	14707-20	66	14915-00	69	15100-AA	71	15406-20	40
14362-02	58	14547-00	57	14662-20	63	14708-06	66	14922-00	70	15101-06	69	15407-16	40
14362-04	58	14548-00	57	14665-06	63	14708-10	66	14922-11	70	15101-10	22	15407-20	40
14362-06	58	14549-00	57	14665-10	63	14708-15	66	14922-22	70	15101-15	69	15409-26	40
14365-02	58	14552-00	58	14665-15	63	14708-20	66	14922-33	70	15101-20	69	15409-30	40
14365-04	58	14555-00	58	14665-20	63	14709-06	66	14922-77	22	15105-06	69	15409-36	40
14365-06	58	14561-15	61	14667-06	64	14709-10	66	14922-99	70	15105-10	22	15415-03	40
14402-00	60	14561-20	61	14667-10	64	14709-15	66	14925-00	70	15105-15	69	15428-06	359
14405-00	60	14562-06	61	14667-15	64	14709-20	66	14925-11	70	15105-20	69	15430-11	40
14407-00	60	14562-10	61	14667-20	64	14710-06	66	14925-22	70	15107-06	69	15438-50	40
14409-01	60	14562-15	61	14668-06	64	14710-10	66	14925-33	70	15107-10	22	15506-16	37
14409-02	60	14562-20	61	14668-10	64	14712-00	66	14925-77	22	15107-15	69	15506-20	37
14480-20	320	14565-06	61	14668-15	64	14715-00	66	14925-99	70	15107-20	69	15506-24	37
14502-00	57	14565-10	61	14668-20	64	14717-00	66	14927-00	70	15108-06	69	15506-28	37

**NUMERICAL INDEX INDICE NUMERICO NUMERISCH INDEX INDEX NUMERIQUE INDICE NUMERICO**

Cod.	pag.	Cod.	pag.	Cod.	pag.	Cod.	pag.	Cod.	pag.	Cod.	pag.	Cod.	pag.
15507-16	37	16109-28	30	16127-40	32	16927-40	108	16961-50	31	18002B26	141	18008-30	142
15507-20	37	16109-32	30	16134-12	41	16927-45	108	16961-60	31	18002R18	141	18008-36	142
15507-24	37	16109-36	30	16135-12	41	16927-50	108	16965-40	33	18002R20	141	18008B30	142
15507-28	37	16109-40	30	16136-10	41	16929-36	30	16965-50	33	18002R22	141	18008R26	142
15508-20	37	16109-45	30	16137-10	41	16929-40	30	16965-60	33	18002R26	141	18008R30	142
15508-24	37	16109-50	30	16138-10	41	16938-36	30	17610-01	107	18002R30	141	18008R36	142
15508-28	37	16109-60	30	16139-10	41	16938-40	30	17610-02	107	18002R36	141	18008Y30	143
15509-20	37	16113-20	32	16302-02	59	16938-45	30	17610-05	107	18002Y18	141	18009-25	143
15509-24	37	16113-24	32	16302-04	59	16939-50	33	17610-10	107	18002Y26	141	18009-30	143
15509-28	37	16113-28	32	16302-06	59	16939-60	33	18000-16	140	18002Y30	141	18009-36	143
15514-20	37	16113-32	32	16303-02	59	16939-70	33	18000-20	140	18002Y36	141	18009B25	143
15514-24	37	16113-36	32	16303-04	59	16939-80	33	18000-23	140	18005-22	140	18009B30	143
15514-28	37	16113-40	32	16303-06	59	16940-28	206	18000-26	140	18005-27	140	18009M25	143
15514-32	37	16114-20	31	16305-02	59	16940-32	206	18000-30	140	18005-32	140	18009R25	143
15515-20	37	16114-24	31	16305-04	59	16940-36	206	18000-36	140	18005B22	141	18009R30	143
15515-24	37	16114-28	31	16305-06	59	16940-40	206	18000B16	140	18005B27	141	18009W25	143
15515-28	37	16114-32	31	16362-02	59	16941-40	33	18000B20	140	18005B32	141	18009W30	143
15515-32	37	16114-36	31	16362-04	59	16941-45	33	18000B23	140	18005G22	141	18009Y25	143
15561-20	37	16114-40	31	16362-06	59	16941-50	33	18000B26	140	18005G27	141	18009Y30	143
15561-24	37	16115-24	31	16363-02	59	16941-60	33	18000B30	140	18005G32	141	18010-25	143
15561-28	37	16115-28	31	16363-04	59	16941-61	33	18000G16	140	18005R22	141	18010-30	143
16101-16	30	16115-32	31	16363-06	59	16943-40	33	18000G20	140	18005R27	141	18010-36	143
16101-20	30	16115-36	31	16365-02	59	16943-45	33	18000G23	140	18005R32	141	18010Y30	143
16101-24	30	16115-40	31	16365-04	59	16943-50	33	18000G26	140	18005Y22	141	18011-32	143
16101-28	30	16115-45	31	16365-06	59	16943-60	33	18000G30	140	18005Y27	141	18012-32	144
16101-32	30	16116-28	32	16712-22	33	16943-61	33	18000M16	140	18005Y32	141	18012B32	144
16101-36	30	16116-32	32	16712-26	33	16944-45	33	18000M20	140	18006-20	142	18013-30	144
16101-40	30	16116-36	32	16712-30	33	16944-50	33	18000M23	140	18006-25	142	18013-36	144
16101-45	30	16116-40	32	16717-20	32	16944-60	33	18000M26	140	18006-30	142	18013G36	144
16101-50	30	16117-20	32	16717-24	32	16947-40	33	18000R16	140	18006-36	142	18013W30	144
16106-16	30	16117-24	32	16717-28	32	16947-45	33	18000R20	140	18006B20	142	18013W36	144
16106-20	30	16117-28	32	16717-32	32	16947-50	33	18000R23	140	18006B25	142	18015-18	144
16106-24	30	16117-32	32	16717-36	32	16947-60	33	18000R26	140	18006B30	142	18015-22	144
16106-28	30	16117-36	32	16717-40	32	16947-61	33	18000R30	140	18006G20	142	18015-27	144
16107-16	30	16117-40	32	16719-12	33	16948-40	33	18000W20	140	18006G25	142	18015B18	144
16107-20	30	16118-24	32	16910-14	33	16948-45	33	18000W26	140	18006R20	142	18015B22	144
16107-24	30	16120-24	32	16910-16	33	16948-50	33	18000W30	140	18006R25	142	18015R18	144
16107-28	30	16120-28	32	16910-18	33	16948-60	33	18000Y16	140	18006R30	142	18015R22	144
16107-32	30	16120-32	32	16910-20	33	16948-61	33	18000Y20	140	18006Y20	142	18015Y18	144
16107-36	30	16120-36	32	16924-20	109	16961-16	31	18000Y23	140	18006Y25	142	18015Y27	144
16107-40	30	16120-40	32	16924-24	109	16961-20	31	18000Y26	140	18006Y30	142	18016-14	144
16107-45	30	16127-16	32	16924-28	109	16961-24	31	18002-18	141	18007-25	142	18016-16	144
16107-50	30	16127-20	32	16926-32	30	16961-28	31	18002-20	141	18007-30	142	18016B14	144
16108-20	30	16127-24	32	16926-36	30	16961-32	31	18002-22	141	18007-36	142	18016B16	144
16108-24	30	16127-28	32	16926-40	30	16961-36	31	18002-26	141	18007G30	142	18016R14	144
16108-28	30	16127-32	32	16927-32	108	16961-40	31	18002-30	141	18008-20	142	18016R16	144
16109-24	30	16127-36	32	16927-36	108	16961-45	31	18002-36	141	18008-26	142	18016W16	144

Cod.	pag.	Cod.	pag.	Cod.	pag.	Cod.	pag.	Cod.	pag.	Cod.	pag.	Cod.	pag.	Cod.	pag.	Cod.	pag.
18016Y14	145	18028-30	147	18110-36	137	18136U33	447	18166-AF	525	18176-40	444	18221-19	149				
18016Y16	145	18028-36	147	18111-30	137	18136U34	449	18166-AH	525	18176A30	446	18221-21	149				
18017-14	145	18028B30	147	18112-30	137	18136U40	448	18166-AM	453	18176A36	446	18221B17	149				
18017-16	145	18028F21	521	18114-20	137	18136U41	449	18166E24	446	18176A40	446	18221B19	149				
18017-18	145	18028F25	521	18115-20	138	18152A54	449	18166E30	446	18176-AE	525	18221B21	149				
18017B16	145	18028F30	521	18115-25	138	18152E54	449	18166E36	446	18176-AF	525	18221G17	149				
18017R16	145	18028F36	521	18116-14	138	18152U54	449	18166E40	446	18176-AH	525	18221G19	149				
18017Y16	145	18028M25	147	18116-18	138	18156A33	449	18166-EB	454	18176E30	446	18221G21	149				
18018-11	145	18028W21	147	18122-12	138	18156A40	449	18166-EC	454	18176E36	446	18221M17	149				
18018R11	145	18028W25	147	18123-11	138	18156E33	449	18166-ED	454	18176E40	446	18221M19	149				
18018Y11	145	18028W30	147	18124-09	138	18156E40	449	18166-EG	454	18176I30	444	18221M21	149				
18019-12	145	18028W36	147	18125-07	138	18156U33	449	18166-EH	454	18176I36	444	18221R17	149				
18019-14	145	18028Y25	147	18125-10	138	18156U40	449	18166-EI	454	18176I40	444	18221R19	149				
18019-16	145	18028Y30	147	18126-07	138	18162-54	445	18166-EJ	454	18176U36	446	18221R21	149				
18019-18	145	18029-25	146	18128-20	138	18162-56	445	18166-EL	454	18176U40	446	18221Y17	149				
18019-20	145	18029-30	146	18128-24	138	18162A54	447	18166-EM	454	18190-09	158	18221Y19	149				
18019R12	145	18029-36	146	18128-30	138	18162A55	445	18166I30	444	18190-AA	525	18221Y21	149				
18019R16	145	18029W25	146	18132A54	448	18162A56	447	18166I36	444	18191-22	158	18222-18	151				
18019R18	145	18029W30	146	18132A55	448	18162A57	445	18166I40	444	18192-09	158	18224-28	150				
18019R20	145	18029W36	146	18132-AE	455	18162-AA	453	18166-KE	455	18199-19	157	18224B28	150				
18020-23	145	18030-26	147	18132-AU	455	18162-AF	524	18166-KP	455	18201-36	150	18224R28	150				
18020B23	145	18030-31	147	18132E54	448	18162-AG	524	18166-KU	455	18203-26	151	18224Y28	150				
18020R23	145	18030-36	147	18132E55	448	18162E54	447	18166U24	446	18205-10	150	18225-28	150				
18021-18	145	18030W26	147	18132-FB	454	18162E55	445	18166U36	446	18205-12	150	18225R28	150				
18021B18	145	18030W31	147	18132-KA	454	18162E56	445	18166U40	446	18206-09	150	18226-17	151				
18021R18	145	18030W36	147	18132-KE	455	18162E57	445	18168A24	446	18207-15	150	18226B17	151				
18022-12	145	18099-15	157	18132-KP	524	18162-KE	455	18168E24	446	18209-06	150	18226G17	151				
18023-11	145	18100-16	137	18132-KQ	524	18162-KU	455	18168-GA	453	18215-13	151	18226R17	151				
18024-08	146	18100-20	137	18132-KU	455	18162-RA	453	18168U24	446	18215-21	151	18226W17	151				
18024-11	146	18100-24	137	18132U54	448	18162-RB	453	18172-54	444	18217-12	146	18226Y17	151				
18024B08	146	18100-30	137	18132U55	448	18162U54	447	18172-56	444	18220-18	149	18230-13	138				
18024B11	146	18100-36	137	18136A33	448	18162U55	445	18172A54	447	18220-20	149	18230-17	138				
18024G08	146	18102-16	137	18136A34	449	18162U56	447	18172A55	445	18220-22	149	18231-13	138				
18024G11	146	18102-20	137	18136A40	448	18162U57	445	18172A56	447	18220-26	149	18235-26	152				
18024M08	146	18102-26	137	18136A41	449	18166-24	444	18172A57	445	18220B18	149	18235-30	152				
18024M11	146	18102-30	137	18136E33	448	18166-30	444	18172-AF	525	18220B20	149	18235B30	152				
18024R08	146	18103-18	137	18136E34	449	18166-36	444	18172-AG	525	18220B22	149	18235G30	152				
18024R11	146	18104-18	137	18136E40	448	18166-40	444	18172E54	447	18220B26	149	18235R30	152				
18024W08	146	18106-15	137	18136E41	449	18166A24	446	18172E55	445	18220R18	150	18235W30	152				
18024W11	146	18106-20	137	18136-EA	454	18166A30	446	18172E56	447	18220R20	150	18235Y30	152				
18024Y08	146	18106-25	137	18136-EB	454	18166A36	446	18172E57	445	18220R22	150	18236-30	152				
18026-07	146	18106-30	137	18136-KA	454	18166A40	446	18172U54	447	18220R26	150	18237-26	152				
18026B07	146	18109-26	137	18136-KE	455	18166-AA	453	18172U55	445	18220Y18	150	18251-01	152				
18026G07	146	18109-30	137	18136-KP	524	18166-AB	453	18172U56	447	18220Y20	150	18251-02	152				
18026M07	146	18109-36	137	18136-KQ	524	18166-AC	453	18172U57	445	18220Y22	150	18255-00	157				
18028-21	147	18110-26	137	18136-KR	524	18166-AD	525	18176-30	444	18220Y26	150	18261-00	152				
18028-25	147	18110-30	137	18136-KU	455	18166-AE	525	18176-36	444	18221-17	149	18263-00	152				



**NUMERICAL INDEX INDICE NUMERICO NUMERISCH INDEX INDEX NUMERIQUE INDICE NUMERICO**

Cod.	pag.	Cod.	pag.	Cod.	pag.	Cod.	pag.	Cod.	pag.	Cod.	pag.	Cod.	pag.
18270-22	153	18502-18	271	18876M01	458	18891N00	460	41200-14	337	41208-02	280	41323-24	330
18271-00	153	18503-12	271	18876N00	457	18891R00	460	41200-15	337	41208-06	280	41323-99	330
18272-00	153	18504-15	271	18876N01	458	18893-00	461	41200-16	337	41210-01	42	41323-AA	526
18273-00	153	18509-01	96	18876R00	457	18893M00	461	41200-17	337	41210-03	42	41325-20	333
18274-00	153	18509-02	96	18876R01	458	18893N00	461	41200-18	338	41210-05	42	41325-30	333
18275-00	152	18509-03	96	18877-00	458	18893R00	461	41200-32	338	41210-07	42	41325-40	333
18276-00	154	18510-07	96	18877M00	458	18895-00	460	41200-33	338	41210-08	42	41326-30	333
18277-00	117	18510F07	521	18877N00	458	18895M00	460	41200-34	338	41210-10	42	41326-36	333
18278-00	153	18511-15	95	18877R00	458	18895N00	460	41200-36	338	41210-12	42	41326-42	333
18279-14	153	18511F15	521	18878-00	458	18895R00	460	41200-40	338	41210-13	42	41327-01	332
18280-10	156	18512-15	95	18878M00	458	18897-00	460	41200-41	338	41210-14	42	41327-02	332
18280-16	156	18513-14	96	18878N00	458	18897M00	460	41200-46	338	41220-01	427	41327-03	332
18280-22	156	18513F14	521	18878R00	458	18897N00	460	41200-47	338	41220-02	426	41327-04	332
18281-24	156	18514-17	96	18879-00	459	18897R00	460	41200-48	338	41220-03	426	41327-05	332
18282-18	156	18514-18	96	18879M00	459	19701-00	128	41200-49	338	41220-04	427	41327-06	332
18282-19	156	18515-16	95	18879N00	459	19702-00	127	41200-50	338	41220-05	427	41327-07	332
18282-22	156	18516-24	96	18879R00	459	19705-00	127	41200-51	338	41220-06	426	41327-08	332
18283-27	156	18517-24	96	18880-00	459	19706-00	127	41200-52	338	41220-07	427	41327-09	332
18283-33	156	18518-22	96	18880M00	459	19709-00	127	41200-53	338	41311-00	359	41327-10	332
18284-21	156	18518-26	96	18880N00	459	19810-00	125	41200-54	338	41311-AA	526	41380-01	133
18284-27	156	18518-30	96	18880R00	459	19810-AA	525	41200-55	338	41311-AB	526	41380-02	133
18284-30	156	18519-15	96	18882-00	459	19810-AB	525	41200-56	338	41312-00	359	41390-00	368
18284-33	156	18519-22	96	18882M00	459	19901-35	461	41200-57	338	41313-00	360	41394-02	367
18301-01	267	18519-26	96	18882N00	459	19901-40	461	41200-58	338	41314-00	360	41400-AA	430
18301-02	267	18519-30	96	18882R00	459	19901-47	461	41200-59	338	41315-02	359	41400-AB	526
18302-01	267	18519-35	96	18884-00	459	19902-38	461	41200-60	338	41315-04	359	41402-AA	526
18302-02	267	18520-04	96	18884M00	459	32931-02	365	41200-61	338	41317-20	360	41403-01	73
18323-00	267	18520-06	96	18884N00	459	32931-03	365	41200-62	338	41318-00	358	41403-02	73
18324-00	267	18520-08	96	18884R00	459	32931-05	365	41200-63	338	41320-25	332	41403-03	73
18324-10	84	18520-10	96	18886-00	457	32935-03	366	41200-64	338	41320-30	332	41403-04	73
18324F10	521	18520-12	96	18886M00	457	32935-05	366	41205-01	329	41320-35	332	41405-AA	430
18325-01	196	18520-15	271	18886N00	457	32935-10	366	41205-02	329	41321-40	333	41405-AB	526
18325-02	196	18874-11	457	18886R00	457	32935-22	366	41205-03	329	41321-44	333	41412-11	429
18325-03	196	18874-22	457	18887-00	457	32936-03	366	41205-04	329	41322-19	333	41413-30	282
18341-KE	455	18874M11	457	18887M00	457	32936-05	366	41205-05	329	41322-25	333	41414-21	281
18341-KU	455	18874M22	457	18887N00	457	41200-01	337	41205-06	329	41322-31	333	41414-30	280
18353-17	438	18874N11	457	18887R00	457	41200-02	337	41205-07	328	41323-01	330	41414-31	281
18353-AA	525	18874N22	457	18888-00	461	41200-03	337	41205-08	328	41323-02	330	41414-36	281
18353-BB	525	18874R11	457	18888M00	461	41200-04	337	41205-09	328	41323-03	330	41415-10	429
18353-CA	525	18874R22	457	18888N00	461	41200-05	337	41205-10	329	41323-04	330	41415-11	425
18353-DB	525	18875-00	458	18888R00	461	41200-06	337	41206-01	333	41323-11	330	41416-18	283
18353-VA	525	18875M00	458	18889-00	460	41200-07	337	41206-02	333	41323-12	330	41418-11	425
18501-01	271	18875N00	458	18889M00	460	41200-08	337	41206-03	280	41323-13	330	41418-12	425
18501-02	271	18875R00	458	18889N00	460	41200-09	337	41206-04	329	41323-14	330	41419-12	425
18501-03	271	18876-00	458	18889R00	460	41200-10	337	41206-05	437	41323-21	330	41425-AA	431
18501-04	271	18876-01	458	18891-00	460	41200-11	337	41207-02	334	41323-22	330	41427-40	431
18501-05	271	18876M00	458	18891M00	460	41200-13	337	41207-03	334	41323-23	330	41429-04	431

Cod.	pag.	Cod.	pag.	Cod.	pag.	Cod.	pag.	Cod.	pag.	Cod.	pag.	Cod.	pag.
41430-11	418	41458-24	296	41472-12	278	41474-00	287	41490-01	302	41503-00	313	41523-08	327
41431-08	286	41458-25	296	41472-13	278	41474-02	287	41490-AA	302	41503-21	313	41523-09	327
41431-12	286	41458-50	296	41472-14	290	41475-00	286	41490B00	302	41503-22	313	41523G08	328
41436-11	419	41458-51	296	41472-15	290	41475-01	286	41490B01	302	41504-09	364	41523G09	328
41436-12	419	41459-10	295	41472-16	289	41475-03	286	41490C00	302	41504-10	364	41524-04	327
41442-03	435	41460-05	295	41472-17	289	41475-04	286	41490C01	302	41504-11	364	41524-09	327
41442-14	433	41460-10	295	41472-18	289	41475-05	286	41490G00	302	41504-12	364	41524-10	328
41442-23	433	41461-07	307	41472-19	290	41475-20	286	41490G01	302	41504-19	364	41524-11	328
41443-AE	526	41461B07	307	41472-20	289	41476-50	287	41491C00	303	41505-17	363	41524-12	328
41445-01	437	41461C07	307	41472-21	289	41477-50	308	41491C01	303	41505-19	363	41524C10	328
41445-02	437	41461G07	307	41472-22	289	41478-35	308	41491C02	303	41505-20	363	41524C11	328
41445-22	410	41463-01	298	41472-23	290	41478-50	308	41491C03	304	41507-01	364	41524C12	328
41445-26	410	41463-02	299	41472-24	289	41479-05	307	41491C04	304	41508-10	364	41525-00	277
41445-30	411	41463A00	300	41472-25	278	41479-11	307	41491C05	304	41508C12	363	41525-01	277
41446-18	410	41463A05	299	41472-26	289	41479-12	307	41491C06	304	41510-08	364	41526-01	106
41446-23	410	41463A30	299	41472-27	289	41479-13	307	41491G00	303	41511-00	365	41526-02	106
41447-02	428	41463A50	299	41472-28	289	41479-14	307	41491G01	303	41511-20	365	41526-05	106
41447-05	428	41463B05	299	41472-29	289	41479-15	307	41491G02	303	41511-30	365	41526-06	106
41447-38	281	41463C00	300	41472-32	283	41479-AA	308	41491G03	304	41512-15	315	41526-B1	106
41447-39	526	41463C30	299	41472-33	293	41480-03	306	41491G04	304	41512-30	315	41526-B2	106
41448-06	432	41463C50	299	41472-34	293	41480-05	306	41491G05	304	41512-50	315	41526-B3	106
41448-10	432	41463G05	299	41472-35	293	41480-07	306	41491G06	304	41513-13	315	41526-G1	106
41448-25	432	41463M05	299	41472-36	293	41480B05	307	41492-00	326	41513B20	315	41526-G2	106
41448-40	432	41464-09	307	41472-37	294	41480C05	307	41492B00	326	41513C20	315	41526-G3	106
41449-27	433	41464B09	307	41472-38	294	41480G05	307	41492C00	326	41513G20	315	41526-R1	106
41449-32	434	41464C09	307	41472-39	294	41481-02	306	41492G00	326	41514-05	308	41526-R2	106
41450-AA	295	41464G09	307	41472-40	294	41481-03	306	41493B00	298	41514-10	308	41526-R3	106
41451-05	295	41465-10	313	41472-41	294	41483-04	306	41493C00	298	41515-03	314	41527-10	327
41451-10	295	41467B08	307	41472-42	294	41483-06	306	41493G00	298	41515-05	314	41527-11	327
41452N10	276	41467C08	307	41472-43	287	41484-05	306	41494B00	298	41515-07	314	41527-12	327
41452N16	276	41467G08	307	41472-44	287	41484B05	306	41494C00	298	41515-08	314	41527-13	327
41453-11	313	41468-20	286	41472-45	288	41484C05	306	41494G00	298	41515-09	314	41527G10	328
41453-AA	313	41468-24	286	41472-46	287	41484G05	306	41495-08	303	41515-10	314	41527G11	328
41454-01	313	41469-20	286	41472-47	294	41486-00	286	41495-10	303	41515-20	314	41527G12	328
41454-99	313	41469-24	286	41472-48	294	41486-01	286	41496-40	365	41515-21	314	41527G13	328
41455-BC	295	41470A00	301	41472-50	294	41486-08	286	41497-05	300	41515-22	314	41528-21	106
41455-CA	296	41470A03	301	41472-55	284	41486-12	286	41497B05	300	41518-00	362	41528-22	106
41455-CB	296	41470C00	301	41472-56	284	41486-15	286	41497C05	300	41518-01	362	41529-05	352
41455T55	295	41470C03	301	41472-80	284	41487-12	286	41497G05	300	41518-02	362	41530-05	352
41456-02	312	41471-00	286	41472-99	284	41487-15	286	41498B00	298	41518B12	315	41530-07	352
41457-00	313	41471-12	286	41473-31	287	41487-17	286	41498C00	298	41518C12	315	41530-11	352
41458-02	295	41471-15	286	41473-39	287	41488-45	287	41498G00	298	41518G12	315	41538-30	280
41458-05	295	41471-17	286	41473-44	287	41488-47	287	41499-08	365	41520-08	107	41541-44	416
41458-10	295	41472-01	288	41473-50	287	41488-50	287	41500-00	324	41520-12	107	41558-00	363
41458-11	296	41472-04	288	41473-56	287	41488-53	287	41500-AA	324	41520-16	107	41559-04	363
41458-21	296	41472-07	288	41473-62	287	41489-20	286	41501-20	363	41520-24	107	41560-28	358
41458-23	295	41472-08	288	41473-66	287	41490-00	302	41502-20	363	41522-14	327	41561-09	352

**NUMERICAL INDEX INDICE NUMERICO NUMERISCH INDEX INDEX NUMERIQUE INDICE NUMERICO**

Cod.	pag.	Cod.	pag.	Cod.	pag.	Cod.	pag.	Cod.	pag.	Cod.	pag.	Cod.	pag.
41562-18	362	41589-58	348	41605-00	304	41638-91	527	41676-00	100	41707-32	35	41743D32	191
41563-07	352	41589-59	348	41605-01	304	41638-92	527	41677-00	100	41707-36	35	41743D53	191
41563-AA	527	41589-99	348	41605-03	304	41638-93	527	41678-00	100	41707-40	35	41743D60	191
41564-07	352	41589-AA	349	41605B03	304	41638-94	527	41678-14	365	41707-45	35	41744-32	190
41564-AA	527	41589-AB	349	41605B27	304	41638-95	527	41679-23	358	41707-50	35	41744-53	190
41569-33	360	41589-AC	349	41605C03	304	41639-11	357	41680-03	316	41708-32	35	41744-60	190
41570-10	111	41589-BB	349	41605G03	304	41639-17	357	41680-06	316	41708-36	35	41745-30	273
41570B10	305	41589C08	349	41605G27	304	41639-30	357	41680-12	316	41708-40	35	41745-35	273
41570C10	305	41589C16	349	41606-00	312	41639-31	357	41681-01	317	41708-45	35	41745-40	273
41570G10	305	41589-CC	349	41606-01	312	41639-32	357	41681-02	317	41708-50	35	41745-50	273
41582-00	162	41591-32	362	41606-02	312	41639-40	358	41681-03	317	41717-60	35	41745-60	273
41583-00	163	41591-36	362	41606-22	312	41639-41	358	41681-04	317	41719-36	35	41745-65	273
41585-00	343	41591-40	362	41607-00	277	41639-42	358	41681-06	317	41719-40	35	41746-60	190
41585-01	343	41591-45	362	41608-00	323	41645-00	277	41681-10	316	41720-18	32	41747-60	191
41585-02	343	41591-90	362	41608-03	323	41646-06	349	41681-11	317	41720-20	32	41748-20	191
41585-03	343	41592-36	362	41608-04	323	41646-10	349	41681-12	317	41720-24	32	41748-30	191
41585-10	343	41592-45	362	41608-08	323	41646-15	349	41681-99	317	41720-28	32	41748-35	191
41585-11	342	41593-20	362	41608-20	323	41646-20	349	41683-26	104	41720-30	32	41748-40	191
41585-12	342	41594-12	361	41609-36	305	41650-06	349	41686-12	361	41720-32	32	41748-50	191
41585-13	342	41594-18	361	41609-75	305	41650-10	349	41690A11	449	41727-28	272	41750-20	191
41585-23	342	41595-20	305	41609B36	305	41650-13	349	41690E11	449	41727-30	272	41750-30	191
41585-24	342	41595B44	113	41609C36	305	41651-20	419	41690U11	449	41727-33	272	41750-40	191
41585-25	342	41595B45	113	41609G36	305	41651-25	419	41691A11	449	41727-36	272	41750-41	191
41585-30	342	41597-04	352	41611-20	311	41651-30	419	41691E11	449	41727-40	272	41750-50	191
41585-37	342	41598-00	352	41614-22	278	41651-35	419	41691U11	449	41727-45	272	41751-30	190
41585-45	343	41599-08	352	41614-33	278	41651-40	419	41695-10	455	41727-50	272	41751-35	190
41585-51	343	41600-00	305	41614-34	278	41651-45	419	41695-15	455	41727-55	272	41751-40	190
41585-52	343	41600C00	305	41614-35	278	41651-50	419	41695-50	455	41727-60	272	41751-50	190
41585-53	343	41600G00	305	41614-36	278	41651-55	419	41695-90	455	41729-30	209	41751-60	190
41585-54	343	41601-17	279	41615-01	353	41651-60	419	41697-00	102	41729-34	209	41751-65	190
41586-22	343	41602-00	279	41615-03	353	41651-65	419	41698-22	102	41734-60	272	41751F30	522
41586-28	343	41603-00	305	41615-05	353	41654-80	419	41698-30	102	41735-20	265	41751F40	522
41586-33	343	41603-07	305	41617-05	279	41654-99	419	41698-40	102	41735-29	264	41751F60	522
41586-38	343	41603B00	305	41617-15	279	41659-06	206	41699-03	325	41736-32	265	41752-08	274
41587-25	343	41603B07	305	41618-14	279	41659-07	206	41699-04	325	41737-17	265	41752-12	274
41587-32	343	41603C00	305	41620-04	352	41659-08	206	41699-06	324	41737-20	265	41752-24	274
41589-07	348	41603C07	305	41628-15	365	41660-10	205	41699-10	324	41737-23	265	41753-30	191
41589-08	347	41603G00	305	41629-17	353	41660-15	205	41699-12	325	41737G20	22	41753-32	191
41589-14	347	41603G07	305	41629-20	353	41670-06	100	41699-13	325	41737G23	22	41753-53	191
41589-15	348	41604-00	305	41629-25	353	41670-09	100	41699-18	325	41738-17	265	41753-60	191
41589-16	347	41604-01	306	41635-02	356	41670-AA	100	41699-20	324	41738-20	265	41753D30	191
41589-20	347	41604B00	305	41636-25	356	41670-AB	100	41699B18	325	41738-23	265	41753D32	191
41589-22	348	41604B01	306	41638-01	357	41671-11	100	41699C18	325	41739-20	265	41753D53	191
41589-25	348	41604C00	305	41638-02	356	41672-00	100	41699G18	325	41740-00	266	41753D60	191
41589-29	348	41604C01	306	41638-04	356	41673-00	100	41703-38	35	41743-32	191	41755-11	274
41589-37	348	41604G00	305	41638-12	356	41674-00	100	41704G33	22	41743-53	191	41756-30	190
41589-50	348	41604G01	306	41638-13	357	41675-00	100	41704G36	22	41743-60	191	41756-32	190

Cod.	pag.	Cod.	pag.	Cod.	pag.	Cod.	pag.	Cod.	pag.	Cod.	pag.	Cod.	pag.	Cod.	pag.
41756-53	190	41770-15	272	41877-81	417	41913-03	434	42400-30	439	42460-45	439	42505-27	161		
41756-60	190	41771-96	272	41877-99	417	41913-04	434	42401-10	349	42460-53	436	42505-50	161		
41758-53	247	41773-00	103	41878-45	417	41914-03	27	42401-15	349	42460-63	430	42506-08	161		
41758-60	247	41774-33	268	41878-61	417	41916-10	110	42401-20	349	42460-64	430	42506-10	161		
41758-65	247	41775-34	268	41878-81	417	41916-15	110	42401-AA	527	42460-74	439	42506-12	161		
41758-85	247	41780-05	261	41878-99	417	41916-20	110	42403-01	350	42460-76	439	42506-14	161		
41759-01	246	41780-07	261	41879-30	417	41919-03	411	42403B01	350	42461-11	425	42506-16	161		
41759-05	246	41780-09	261	41879-40	417	41922-16	110	42405-10	350	42461-35	425	42506-18	161		
41759-09	246	41781-05	264	41879-50	417	41922-22	110	42405-20	350	42462-11	422	42507-12	160		
41760-02	246	41781-10	264	41879-61	417	41925-14	111	42405-AA	528	42462-12	422	42508-00	162		
41760-05	246	41781-15	264	41880-38	417	41925-16	111	42406-35	439	42462-13	422	42508-01	162		
41760-06	246	41782-04	319	41880-61	417	41925-18	111	42406-40	439	42462-14	422	42509-25	103		
41760-08	247	41782-05	319	41881-30	417	41925-20	111	42407-03	350	42462-16	422	42509-50	103		
41760-09	247	41782-06	319	41881-40	417	41925-22	111	42407-06	350	42462-23	422	42509-60	104		
41760-20	246	41800-05	438	41882-15	417	41925-24	111	42408-03	350	42463-11	422	42509-99	104		
41760-21	246	41800-10	438	41882-20	417	41925-26	111	42408-06	350	42463-12	422	42510-00	161		
41760-22	245	41801-05	438	41882-25	417	41929-00	101	42408-08	350	42463-13	422	42511-20	160		
41760-26	245	41806-00	437	41882-30	417	41929-02	101	42413-24	360	42463-14	422	42511-25	160		
41760-27	245	41806-03	437	41885-30	417	41930-39	27	42414-05	360	42463-16	422	42511-30	160		
41761-02	266	41807-12	438	41885-40	417	41931-08	112	42414-10	360	42463-23	422	42511-35	160		
41762-07	271	41808-04	439	41885-45	417	41931-14	112	42414-15	360	42463A00	436	42511-40	160		
41762-09	271	41809-09	454	41885-50	417	41931-16	112	42414-20	360	42463A02	420	42511-56	160		
41762-13	271	41810-04	437	41885-60	417	41931-18	112	42417-22	360	42463A04	420	42511-60	160		
41763-00	271	41810-09	438	41900-04	439	41932-05	112	42420-06	359	42463A05	420	42511-70	160		
41763-30	472	41820-03	364	41900-10	439	41933-18	112	42420-08	359	42463A08	420	42512-35	104		
41764-28	265	41860-36	480	41901-08	438	41940-06	429	42440-30	418	42463B00	436	42512-90	481		
41764-33	265	41860-43	480	41901-16	438	41940B06	429	42441-25	418	42463B02	420	42512-91	481		
41764-40	265	41860-47	480	41903A10	450	41941-43	429	42442-24	418	42463B04	420	42512-92	481		
41765-32	264	41861-44	481	41903E10	450	41941-44	429	42443-06	366	42463B05	421	42512-93	481		
41765-37	264	41862B11	481	41903U10	450	41944-06	428	42443-08	366	42463B08	421	42513-30	104		
41765-41	264	41862B53	481	41904-10	439	41944B06	428	42445-03	367	42470-00	430	42513-45	104		
41765-45	264	41862C11	481	41905-38	428	41945-38	428	42445-04	418	42470-06	430	42514-20	160		
41765-50	264	41862C53	481	41906-60	429	41960-08	109	42445-05	418	42470-27	431	42515-18	160		
41766-14	265	41862G11	481	41907-04	439	41960-10	109	42446-04	367	42470-43	436	42515-20	160		
41766-16	265	41862G53	481	41907-06	439	41960-12	109	42450-00	429	42470-45	439	42516-18	160		
41766-27	265	41870-01	414	41907-56	428	41960-15	109	42450-AD	430	42470-53	436	42516-20	160		
41767-20	265	41870-02	414	41908-00	435	41961-10	109	42451-11	430	42470-63	430	42517-06	160		
41767-AA	527	41870-03	414	41908-01	435	41961-12	109	42451-12	430	42470-64	430	42518-01	164		
41767G20	22	41870-04	414	41909-08	438	41961-15	109	42452-14	431	42470-74	439	42518-50	165		
41768-21	265	41875-40	417	41910-AL	527	41962-10	109	42452-23	431	42470-76	439	42519-01	166		
41768-22	265	41875-61	417	41911-02	435	41962-12	109	42452-35	425	42501-15	161	42520-00	166		
41769-00	266	41876-30	417	41911-03	435	41962-15	109	42452-53	425	42501-20	161	42520-AA	528		
41769-01	266	41876-38	417	41911-04	436	41964-45	27	42453-23	431	42502-11	161	42521-16	164		
41769-02	266	41876-45	417	41911-AA	527	41964-60	27	42460-00	430	42503-10	161	42521-24	164		
41769-36	266	41876-58	417	41911-AE	527	41980-99	103	42460-06	430	42504-09	103	42522-00	164		
41769-50	266	41877-45	417	41912-03	434	42400-19	439	42460-27	431	42505-21	161	42522-01	164		
41769G00	266	41877-61	417	41912-04	434	42400-25	439	42460-43	437	42505-24	161	42522-02	164		



**NUMERICAL INDEX INDICE NUMERICO NUMERISCH INDEX INDEX NUMERIQUE INDICE NUMERICO**

Cod.	pag.	Cod.	pag.	Cod.	pag.	Cod.	pag.	Cod.	pag.	Cod.	pag.	Cod.	pag.
42522-03	164	42538-02	22	42560-06	122	42577-93	528	42617-04	352	42666P27	376	42679P12	382
42522-04	164	42538-03	22	42560-07	122	42577-94	528	42617-05	352	42666P30	376	42679S12	382
42522-05	164	42538-04	22	42560-08	122	42577-99	528	42617-06	352	42666P40	376	42680-13	385
42522-07	22	42538-05	22	42560-09	122	42579-00	162	42617-07	352	42666S12	376	42681-16	385
42522-09	164	42538-07	22	42562-12	105	42581-01	105	42620P01	380	42666S18	376	42682P18	378
42522F09	522	42538-09	22	42562-14	105	42581-03	105	42620P02	380	42666S22	376	42682S18	378
42523-00	159	42538F09	522	42562-16	105	42581-05	105	42620P03	380	42666S27	376	42683P18	379
42524-06	161	42539-00	164	42562-18	105	42581-10	105	42623-10	100	42666S30	376	42683S18	379
42524-08	161	42539-01	164	42562-20	105	42581-15	105	42624P10	377	42666S40	376	42684P08	380
42524-10	161	42539-02	164	42562-25	105	42581-20	105	42624S10	377	42667P12	377	42684S08	380
42524-12	161	42539-03	164	42562-30	105	42584-01	357	42650-10	116	42667P18	377	42685-22	385
42524-14	161	42539-04	164	42563-00	118	42584-02	357	42650-11	116	42667P22	377	42685P14	379
42524-16	161	42539-05	164	42563-44	118	42584-04	357	42653-04	112	42667P30	377	42685S14	379
42524-18	161	42539-07	22	42565-00	118	42584-05	357	42655P15	379	42667S12	377	42687P18	374
42524-20	161	42539-09	164	42566-03	117	42584-06	357	42655S15	379	42667S18	377	42687P22	374
42524-22	161	42539F09	522	42569-04	123	42584-07	357	42660-02	384	42667S22	377	42687S18	374
42524-30	161	42540-40	165	42570-32	124	42585-00	468	42661-02	380	42667S30	377	42687S22	374
42525-27	161	42540-50	165	42570-91	528	42585-04	468	42661-03	380	42668P12	376	42688P18	374
42526-12	161	42540-80	165	42570-92	528	42585-06	468	42661-06	380	42668P18	376	42688P22	374
42526-14	161	42541-06	165	42570-94	528	42586-09	468	42662C14	383	42668P22	376	42688P30	374
42529-06	160	42542-00	166	42570-99	528	42586-10	468	42662P14	383	42668P30	376	42688S18	374
42530-26	162	42543-00	165	42571-20	124	42587-04	468	42662S14	383	42668P40	376	42688S22	374
42530-32	162	42543-01	165	42572-24	124	42588-00	115	42663C14	383	42668S12	376	42688S30	374
42530-41	162	42543-02	165	42573-31	124	42588-01	115	42663P14	383	42668S18	376	42689-15	383
42530-50	162	42543-03	165	42573-91	528	42589-00	117	42663S14	383	42668S22	376	42690-15	383
42531-26	162	42543-04	165	42573-92	528	42592-01	102	42664P12	377	42668S30	376	42701-10	377
42531-32	162	42543-05	165	42573-94	528	42592-02	102	42664P18	377	42669C14	383	42701P10	377
42531-41	162	42544-00	165	42573-99	528	42593-00	358	42664P22	377	42669P14	383	42702-10	378
42531-50	162	42544-01	165	42574-37	124	42595-01	115	42664P30	377	42669S14	383	42702P10	378
42532-29	162	42544-02	165	42574-90	528	42596-02	116	42664P40	377	42670B14	382	42703-10	377
42532-58	162	42544-03	165	42574-91	528	42597-00	115	42664S12	377	42670N14	382	42703S10	377
42533-23	199	42544-04	165	42574-92	528	42598-00	116	42664S18	377	42670W14	382	42704-10	378
42533-26	199	42544-05	165	42574-93	528	42599-06	117	42664S22	377	42674P18	377	42704S10	378
42533-31	199	42546-00	164	42574-94	528	42599-08	117	42664S30	377	42674P22	377	42705M15	384
42533-36	199	42546-01	164	42574-99	528	42607-05	199	42665P12	374	42674P30	377	42705P10	378
42533-40	199	42546-02	164	42575-37	124	42609-10	107	42665P18	374	42674S18	377	42705P16	381
42534-26	162	42546-03	164	42575-90	528	42609-15	107	42665P22	374	42674S22	377	42705P21	381
42534-32	162	42546-04	164	42575-91	528	42609-20	107	42665P30	374	42674S30	377	42705S10	378
42534-41	162	42546-05	164	42575-92	528	42609-23	107	42665P40	374	42676P15	379	42705S16	381
42535-24	165	42555-11	261	42575-93	528	42609-25	107	42665S12	374	42676P20	379	42705S21	381
42535-32	165	42556-00	123	42575-94	528	42614-04	248	42665S18	374	42676S15	379	42707P21	378
42535-49	165	42558-00	124	42575-99	528	42614-05	248	42665S22	374	42676S20	379	42707S21	378
42537-40	164	42560-01	122	42576-00	124	42614-06	248	42665S30	374	42677P14	379	42710-11	380
42537-50	164	42560-02	122	42577-39	124	42614-07	248	42665S40	374	42677S14	379	42713P10	378
42537-80	164	42560-03	122	42577-90	528	42614-21	199	42666P12	376	42678P14	382	42713S10	378
42538-00	22	42560-04	122	42577-91	528	42615-04	105	42666P18	376	42678S14	382	42714P10	378
42538-01	22	42560-05	122	42577-92	528	42616-04	105	42666P22	376	42678W14	382	42714S10	378

Cod.	pag.	Cod.	pag.	Cod.	pag.	Cod.	pag.	Cod.	pag.	Cod.	pag.	Cod.	pag.	Cod.	pag.	Cod.	pag.
42717P16	381	42749P22	374	42873-02	427	42907-08	101	42950-02	341	42967-17	423	42990-29	426				
42717S16	381	42749S18	374	42874-01	420	42907-09	101	42950-03	341	42967-18	423	42990M16	426				
42718P18	376	42749S22	374	42874-02	420	42907-10	101	42950-04	341	42967-35	423	42990M20	426				
42718P22	376	42764M15	384	42874-03	420	42907-30	101	42950-05	341	42967-43	424	42990M29	426				
42718S18	376	42764P16	380	42874-04	420	42907-35	101	42950-06	341	42967-53	424	42990N16	426				
42718S22	376	42764P21	380	42875-17	354	42907-40	101	42950-07	341	42967-63	422	42990N20	426				
42720-01	384	42764S16	380	42875-20	354	42908-24	112	42950-08	341	42967-64	422	42990N29	426				
42721P18	377	42764S21	380	42875B17	354	42920-02	277	42950-09	341	42967-65	422	42991-25	425				
42721P22	377	42767P12	379	42875B20	354	42921-00	357	42950-92	341	42967-66	422	42991-32	425				
42721P30	377	42767P15	379	42876-20	354	42923-07	277	42950-93	341	42967-67	422	42991M25	425				
42721S18	377	42767P20	379	42876-25	354	42924-02	355	42950-94	341	42967-68	422	42991M32	425				
42721S22	377	42767S12	379	42876B20	354	42926-12	355	42951-08	367	42967-73	422	42991N25	425				
42721S30	377	42767S15	379	42876B25	354	42927-02	355	42951-57	367	42967-74	422	42991N32	425				
42723P10	384	42767S20	379	42877-17	353	42928-00	355	42951-59	367	42967-75	422	42993-40	426				
42723S10	384	42785S20	384	42877-25	353	42929-01	355	42952-05	367	42967-76	422	42993M40	426				
42725P10	384	42786S20	384	42878-17	353	42929-02	356	42953-04	358	42967-77	422	42993N40	426				
42725S10	384	42796P16	381	42878-25	353	42929-03	356	42954-04	367	42967-78	422	44009-00	469				
42727-09	381	42796P23	381	42879K12	353	42929-AA	529	42954-18	367	42968-38	423	44020-21	469				
42727-12	381	42796S16	381	42879K15	353	42929-AB	529	42954-29	367	42968-42	424	44023-00	468				
42727-18	381	42796S23	381	42879K22	353	42929-AC	529	42954-46	367	42969-11	424	44023-AA	529				
42727-22	381	42798P11	381	42879K25	353	42931-19	355	42955-00	358	42969-31	424	44024-00	468				
42727-30	381	42798S11	381	42879M12	353	42935-19	354	42956-19	312	42969-36	424	44025-50	469				
42727-38	381	42801P14	384	42879M15	353	42935-26	354	42956-24	312	42972-01	424	44026-60	486				
42728-09	381	42801S14	384	42879M22	353	42936-23	424	42956-28	312	42972-02	424	44027-00	469				
42728-12	381	42822-00	267	42879M25	353	42936-24	424	42959-12	361	42972-03	424	44027-AA	529				
42728-18	381	42826-32	267	42900-15	101	42936-28	424	42959-13	361	42972-04	424	44028-19	472				
42728-22	381	42826-37	267	42900-24	101	42939-15	366	42962-04	433	42972-28	423	44029-00	469				
42728-30	381	42854B25	102	42901-20	101	42939-AA	529	42962-26	279	42973-30	423	44030-03	482				
42728-38	381	42854B30	102	42901-25	101	42940-03	415	42962-30	433	42973-45	423	44031-01	483				
42728S18	381	42854C25	102	42901-30	101	42941-22	366	42962-44	433	42973-60	423	44031-02	483				
42741-22	378	42854C30	102	42901-35	101	42941-AA	529	42962C26	279	42973-61	423	44031-04	469				
42742-22	378	42854G25	103	42901-40	101	42942-16	365	42962C44	433	42974B13	354	44031-05	469				
42746P12	375	42854G30	103	42902-30	102	42944-23	354	42963-55	422	42974C13	354	44033-23	473				
42746P18	375	42854K25	103	42902-31	102	42945-18	354	42964-53	166	42974M13	354	44033-38	473				
42746P22	375	42854K30	103	42902B30	304	42945-23	354	42964-60	166	42974N13	354	44034-11	473				
42746P30	375	42854R25	103	42902C30	304	42945-27	354	42965-12	424	42979-00	415	44040-40	470				
42746P40	375	42854R30	103	42902G30	304	42946-23	424	42967-03	423	42979-36	415	44041-00	470				
42746P50	375	42854Y25	103	42903-29	103	42946-37	424	42967-04	423	42979-45	415	44041-01	470				
42746P80	375	42854Y30	103	42904-01	102	42947-23	424	42967-05	423	42980-01	415	44041-03	470				
42746S18	375	42862-00	102	42904-02	102	42947-30	424	42967-06	423	42980-02	416	44041-04	470				
42746S22	375	42863-00	102	42904-03	102	42947-40	424	42967-07	423	42981-73	415	44041-05	470				
42746S30	375	42864-10	163	42907-01	101	42948-18	354	42967-08	423	42982-08	41	44042-00	470				
42747P12	375	42870-50	422	42907-02	101	42948-20	354	42967-11	425	42988-99	405	44043-00	470				
42747P18	375	42870-51	422	42907-03	101	42948-23	354	42967-13	423	42988C99	405	44044-00	470				
42747S12	375	42870-59	426	42907-04	101	42948-25	354	42967-14	423	42988G99	405	44047-17	469				
42747S18	375	42872-02	426	42907-06	101	42949-26	427	42967-15	423	42990-16	426	44047-19	469				
42749P18	374	42873-01	354	42907-07	101	42950-01	341	42967-16	423	42990-20	426	44047-22	469				

**NUMERICAL INDEX INDICE NUMERICO NUMERISCH INDEX INDEX NUMERIQUE INDICE NUMERICO**

Cod.	pag.	Cod.	pag.	Cod.	pag.	Cod.	pag.	Cod.	pag.	Cod.	pag.	Cod.	pag.
44047-25	469	44094-03	464	44106R10	318	44114-01	323	44170-00	488	44201R24	44	44234-12	47
44047-28	469	44094-04	464	44106R20	318	44114-02	323	44170-01	488	44201R28	44	44234-16	47
44048-99	326	44094-05	464	44106R25	318	44114-03	323	44171-24	490	44201R32	44	44234S16	47
44055-10	322	44094-06	464	44106W05	317	44118-10	323	44171-50	490	44201V10	44	44237S15	48
44055-20	322	44094R00	463	44106W10	317	44118-20	323	44172-30	490	44201V12	44	44240-08	48
44055-25	322	44094-RE	529	44106W20	317	44118-25	323	44173-00	490	44202-10	44	44240S08	44
44055-30	322	44095-12	492	44106W25	317	44118-30	323	44174-24	487	44202N12	44	44241-19	48
44055-35	322	44095-18	492	44106Y05	317	44118-35	323	44174-AA	530	44202N25	45	44242-00	48
44055-40	322	44095-30	483	44106Y10	317	44118-40	323	44175-15	487	44202N29	45	44243-00	48
44055-50	322	44095-32	483	44106Y20	317	44118-50	323	44176-30	487	44202R12	44	44244S36	48
44055C30	322	44096-80	492	44106Y25	317	44119-01	323	44177-12	487	44202R29	45	44245S32	48
44055C40	322	44096B80	492	44107B05	318	44119-02	323	44178-01	486	44204R24	45	44246S14	48
44055G30	322	44096G80	492	44107B10	318	44119-03	323	44178-02	486	44204R28	45	44246S17	48
44055G40	322	44096R80	492	44107B20	318	44119-04	323	44178-15	486	44207-20	44	44247S16	48
44056-01	322	44096Y80	492	44107B25	318	44119-06	323	44178-16	486	44208G00	44	44248S60	334
44056-04	321	44097-00	490	44107G05	318	44130-01	321	44178-17	487	44208R00	44	44250S30	334
44056-06	321	44099-03	319	44107G10	318	44130-02	321	44178-18	487	44209R26	45	44254-30	334
44056-11	322	44100-01	319	44107G20	318	44130-03	321	44178-19	487	44209R32	45	44256-02	334
44056-21	322	44100-02	319	44107G25	318	44135-02	321	44178-20	487	44210-26	45	44256-03	334
44057-04	321	44100-04	319	44107O05	318	44141-01	488	44183-01	494	44210-32	45	44256-04	334
44057-06	321	44101-03	319	44107O10	318	44141-03	488	44183-A3	494	44210-42	45	44258-60	334
44058-10	322	44101-AA	529	44107O20	318	44142-40	489	44183-A4	494	44210S32	45	44264-35	334
44058-20	322	44102-24	315	44107O25	318	44147-00	489	44184-01	494	44212-30	46	44265-35	334
44058-25	322	44103-03	319	44107R05	318	44147-01	489	44184-A3	494	44213-24	45	44312A06	77
44058-30	322	44103-04	319	44107R10	318	44147-02	489	44184-A4	494	44213-36	45	44312B06	77
44058-40	322	44103-06	319	44107R20	318	44147-03	489	44185-50	368	44214-25	46	44312G06	77
44058-50	322	44103-AA	530	44107R25	318	44148-01	488	44185-70	368	44215S16	47	44312O06	77
44060-01	321	44103-AB	530	44107W05	318	44149-03	488	44187-40	368	44216S16	46	44312R06	77
44060-02	321	44103-AC	530	44107W10	318	44150-19	488	44187-60	368	44217-45	46	44312Y06	77
44060-50	103	44104-01	278	44107W20	318	44151-00	488	44201-01	44	44218R30	45	44313B06	77
44060-51	321	44104-02	278	44107W25	318	44151-AA	488	44201-03	44	44218R40	45	44313G06	77
44060-80	103	44104-15	278	44107Y05	318	44151-AB	488	44201-10	44	44219R26	45	44313O06	77
44060-99	321	44105-00	313	44107Y10	318	44151-AC	488	44201B10	44	44220-AA	530	44313R06	77
44061-08	103	44106-12	319	44107Y20	318	44160-03	488	44201B12	44	44220S24	47	44313Y06	77
44061-09	103	44106B05	318	44107Y25	318	44160-AA	530	44201N10	44	44221S30	47	44314A06	77
44061-12	103	44106B10	318	44108-01	315	44161-00	489	44201N12	44	44222S20	47	44314B06	77
44061-14	103	44106B20	318	44108-02	315	44164-00	489	44201N16	45	44222S28	47	44314G06	77
44077-00	489	44106B25	318	44110-00	323	44165-35	489	44201N20	45	44224-22	46	44314O06	77
44077-06	489	44106G05	317	44110-01	322	44165-40	489	44201N24	45	44224S22	46	44314R06	77
44077-10	490	44106G10	317	44110-02	322	44165-50	489	44201N28	45	44225-22	46	44314Y06	77
44077-CC	489	44106G20	317	44110-03	322	44166-28	489	44201N32	45	44226S30	46	44315A06	77
44089-12	492	44106G25	317	44110-04	322	44167-13	489	44201O10	44	44227-30	46	44315B06	77
44093-00	418	44106O05	318	44110-05	322	44168-12	490	44201O12	44	44228S23	47	44315G06	77
44093-01	418	44106O10	318	44110-06	322	44169B06	490	44201R10	44	44230S14	47	44315O06	77
44094-00	463	44106O20	318	44111-02	322	44169B14	490	44201R12	44	44232S16	47	44315R06	77
44094-01	463	44106O25	318	44112-01	323	44169R06	490	44201R16	44	44232S20	47	44315Y06	77
44094-02	463	44106R05	318	44112-02	323	44169R25	490	44201R20	44	44233-20	47	44317A06	77

Cod.	pag.	Cod.	pag.	Cod.	pag.	Cod.	pag.	Cod.	pag.	Cod.	pag.	Cod.	pag.	Cod.	pag.
44317B06	77	44371-44	50	44394-21	50	44456B14	250	44473-33	331	44477-79	410	44480-18	345		
44317G06	77	44371-48	50	44395-18	50	44457-32	250	44473-34	331	44477-80	410	44480-19	344		
44317O06	77	44372-26	50	44397-18	50	44457B32	250	44474-09	282	44477-81	410	44480-20	344		
44317R06	77	44372-32	50	44412-00	60	44459-28	251	44474-13	282	44478-20	345	44501-01	28		
44317Y06	77	44372-36	50	44421-00	60	44459B28	251	44474-24	282	44478-21	345	44501-02	28		
44322-02	60	44372-40	50	44422-00	60	44461-20	251	44474-25	282	44478-22	345	44501-03	28		
44322-04	60	44374-22	50	44423-00	60	44461B20	251	44474-33	282	44478-23	346	44501-04	28		
44322-06	60	44374-25	50	44430-60	190	44462-25	251	44474-34	282	44478-24	346	44502-01	28		
44332-03	74	44374-32	50	44430-61	190	44462B25	251	44474-38	282	44478-25	346	44502-02	28		
44332-06	74	44374-36	50	44431-46	190	44463-11	250	44474-39	282	44478-26	346	44502-03	28		
44332B06	74	44374-40	50	44431-60	190	44464-23	250	44475-80	283	44478-27	346	44502-04	28		
44333-03	75	44374-44	50	44432-21	60	44465-24	250	44475-81	283	44478-28	346	44503-01	28		
44333-06	75	44375-25	50	44446-10	407	44466-07	291	44475-82	283	44478-29	346	44503-02	28		
44333B06	75	44376-40	50	44446-14	407	44466-11	335	44475-83	283	44478-30	346	44503-03	28		
44334-03	75	44379-05	353	44446-18	407	44466-12	335	44476-20	413	44478-31	346	44503-04	28		
44334-06	75	44382A06	74	44446B10	407	44466-13	335	44476-26	413	44478-32	346	44505-10	478		
44335-03	75	44382B06	74	44446B14	407	44466-14	335	44476-27	413	44478-33	346	44505-15	478		
44335-06	75	44382G06	74	44446B18	407	44466-15	335	44476-28	413	44478-34	346	44505-20	478		
44335B06	75	44382O06	74	44449-30	407	44466-16	404	44476-29	413	44478-35	346	44505-25	478		
44337-03	75	44382Y06	74	44449-32	407	44466-30	291	44476-30	413	44478-70	412	44506-09	478		
44337-06	75	44383O06	75	44449B30	407	44470-03	408	44476-31	413	44478-71	412	44511-27	474		
44337B06	75	44383Y06	75	44449B32	407	44470-04	408	44476-32	413	44478-72	412	44511-34	474		
44338-03	75	44384A06	75	44450-11	251	44470-11	408	44476-33	413	44478-73	412	44511-38	474		
44338-06	75	44384O06	75	44450-12	251	44470-12	408	44476-51	413	44478-74	412	44511-42	474		
44339-03	75	44384R06	75	44450-13	251	44470-13	408	44476-52	413	44478-75	412	44511-63	474		
44339-06	75	44384Y06	75	44450-15	251	44470-14	408	44476-53	413	44478-76	412	44511-90	474		
44342-06	77	44385A06	75	44450-17	251	44470-22	409	44477-24	410	44478-77	411	44511E21	473		
44343-06	77	44385B06	75	44450-21	251	44470-24	409	44477-25	410	44478-78	411	44511E63	473		
44344-06	77	44385G06	75	44450-23	251	44470-30	408	44477-26	410	44478-79	411	44511E90	473		
44345-06	77	44385O06	75	44450B11	251	44470-31	409	44477-27	410	44478-80	411	44512000	473		
44346-06	77	44385R06	75	44450B12	251	44470-38	409	44477-28	410	44480-00	345	44512-34	474		
44347-06	77	44385Y06	75	44450B13	251	44470-40	408	44477-40	410	44480-01	345	44512-42	474		
44352-30	454	44387A06	75	44450B15	251	44470-73	408	44477-41	410	44480-03	344	44512-63	474		
44352-40	454	44387B06	75	44450B17	251	44470-74	408	44477-44	410	44480-04	345	44512-90	474		
44355-30	454	44387G06	75	44450B21	251	44470-75	408	44477-52	410	44480-05	345	44512E12	473		
44355-40	454	44387O06	75	44450B23	251	44471-11	331	44477-53	410	44480-06	344	44512E21	473		
44357-07	252	44387R06	75	44451-22	251	44471-12	331	44477-54	410	44480-07	344	44513000	473		
44357-10	353	44387Y06	75	44451B22	251	44471-13	331	44477-55	410	44480-08	344	44513-34	474		
44357-15	353	44389-32	50	44452-31	250	44471-14	331	44477-64	410	44480-09	344	44513-38	474		
44357B10	353	44390-07	50	44452B31	250	44471-24	331	44477-65	410	44480-10	344	44513-54	474		
44357B15	353	44390-09	50	44453-14	250	44473-02	268	44477-66	410	44480-11	344	44513-63	474		
44366-10	369	44390-11	50	44453B14	250	44473-03	268	44477-67	410	44480-12	344	44513-90	474		
44371-24	50	44390-15	50	44454-11	250	44473-05	331	44477-68	410	44480-13	344	44513E12	473		
44371-28	50	44390-18	50	44454B11	250	44473-07	331	44477-69	410	44480-14	344	44513E21	473		
44371-32	50	44390-23	50	44455-09	250	44473-08	331	44477-76	410	44480-15	344	44521000	474		
44371-36	50	44391-12	50	44455B09	250	44473-31	331	44477-77	410	44480-16	344	44521-16	474		
44371-40	50	44394-18	50	44456-14	250	44473-32	331	44477-78	410	44480-17	345	44521-21	474		



**NUMERICAL INDEX INDICE NUMERICO NUMERISCH INDEX INDEX NUMERIQUE INDICE NUMERICO**

Cod.	pag.	Cod.	pag.	Cod.	pag.	Cod.	pag.	Cod.	pag.	Cod.	pag.	Cod.	pag.
44521-31	474	44701T32	389	44807-28	481	44840-02	402	44843B24	404	44871-32	310	44884-19	432
44521E10	474	44701T40	389	44807-36	481	44840-03	402	44844-01	403	44871-33	311	44884-25	432
44522000	474	44702B21	389	44818-11	73	44840-04	402	44844-11	403	44871-34	310	44884B12	432
44522-16	474	44702B28	389	44818-12	73	44840-05	402	44844B01	403	44871-35	311	44884B19	432
44522-21	474	44702B36	389	44818-13	73	44840-06	432	44845-21	281	44871B20	310	44884B25	432
44522-31	474	44702C21	389	44818-14	73	44840-07	432	44845-30	404	44871B21	310	44885-19	432
44522E10	474	44702C28	389	44818-16	73	44840-08	413	44845-31	281	44871G20	310	44885-25	432
44620-01	471	44702C36	389	44819-02	483	44840-10	413	44845-38	280	44871G21	310	44888-32	409
44620-02	471	44702M21	390	44819-03	482	44840-18	413	44845-39	281	44871L20	310	44888-35	409
44620-03	471	44702M28	390	44820-80	482	44840-27	349	44845-41	404	44871L21	310	44888-40	409
44620-04	471	44702M36	390	44820-99	482	44840-28	349	44845-51	404	44871R20	310	44889-32	409
44620-05	471	44702R21	390	44822-80	482	44840-30	412	44846-05	403	44871R21	310	44889-35	409
44620-06	471	44702R28	390	44822-99	482	44840-31	412	44846-09	403	44873-06	281	44889-40	409
44620-07	471	44702R36	390	44825-20	483	44840-32	412	44846-13	403	44873-08	281	44930-10	478
44620-14	471	44702S21	390	44825-40	483	44840-40	412	44846-15	403	44873-10	281	44930-20	478
44620-17	471	44702S28	390	44826-00	482	44840-41	412	44846B05	335	44873-15	281	44932-15	478
44625-03	471	44702S36	390	44826-20	483	44840-42	412	44846B09	403	44873-16	281	44932-20	478
44625-04	471	44702T21	390	44830-52	479	44840-50	411	44846B13	403	44873-17	281	44934-30	478
44625-05	471	44702T28	390	44830-72	479	44840-51	411	44846B15	403	44874-08	280	44936-02	478
44625-06	471	44702T36	390	44830-99	479	44840-52	411	44847-09	403	44874-16	280	44936-20	478
44625-07	471	44703B27	391	44831-52	479	44840-53	411	44847-13	403	44877-11	72	44936-57	478
44625-08	471	44703B34	391	44832-99	479	44840-54	411	44847-20	403	44877-12	72	44940-01	308
44625-26	471	44703C27	391	44833-99	479	44840-55	411	44847B09	402	44877-13	73	44940-02	308
44625-34	471	44703C34	391	44834-00	406	44840-56	411	44847B13	402	44877-14	73	44940-06	308
44630-01	132	44703R27	392	44834-01	406	44840-57	411	44847B20	402	44877-16	73	44940-08	308
44630-02	21	44703R34	392	44834-02	406	44840-58	411	44849-27	405	44877-24	72	44940-10	308
44630-03	132	44703S27	392	44834-03	406	44841-18	403	44849-34	405	44877B11	72	44940-11	309
44630-04	133	44703S34	392	44834G00	406	44841-21	403	44849-47	405	44877B12	72	44940-12	309
44630-05	133	44705C37	392	44834G01	406	44841-26	403	44850-00	405	44877B13	73	44940-13	309
44630-06	21	44706B31	392	44834G02	406	44841-37	403	44850-11	405	44877B14	73	44940-14	309
44630-07	22	44706B40	392	44834G03	406	44841-51	403	44850-12	405	44877B16	73	44940-16	309
44701B25	388	44706C31	392	44835-36	406	44841B51	403	44850-13	253	44877B24	72	44940-17	309
44701B32	388	44706C40	392	44835-45	406	44842-30	404	44850B11	405	44878-11	72	44940-18	309
44701B40	388	44706R31	394	44835-53	406	44842-31	404	44850B12	405	44878-12	72	44940-19	309
44701C25	388	44706R40	394	44835G36	406	44842-35	404	44850B13	253	44878-13	73	44940-24	309
44701C32	388	44706S31	394	44835G45	406	44842-53	404	44850G12	405	44878-14	73	44940-25	309
44701C40	388	44706S40	394	44835G53	406	44842B31	404	44851-01	405	44878-16	73	44940-26	309
44701M25	388	44708B28	394	44836-30	406	44842B53	404	44851-02	405	44878-24	72	44940-32	310
44701M32	388	44708C28	394	44836G30	406	44843-11	404	44851-03	405	44878B11	72	44940-33	310
44701M40	388	44708R28	395	44837-05	431	44843-12	404	44871-20	310	44878B12	72	44940-34	310
44701R25	388	44708S28	395	44837-20	431	44843-13	404	44871-21	310	44878B13	73	44941B05	300
44701R32	388	44801-09	482	44837-25	431	44843-14	404	44871-22	310	44878B14	73	44941C05	300
44701R40	388	44801-18	483	44837B05	430	44843-24	404	44871-23	310	44878B16	73	44941G05	300
44701S25	389	44803-10	481	44837B20	430	44843B11	404	44871-28	310	44878B24	72	44942-01	311
44701S32	389	44803-20	481	44837B25	430	44843B12	404	44871-29	311	44882-35	409	44942-02	311
44701S40	389	44803-30	481	44837C20	431	44843B13	404	44871-30	310	44882-46	409	44942-03	311
44701T25	389	44807-18	482	44840-01	402	44843B14	404	44871-31	311	44884-12	432	44942-04	311

Cod.	pag.	Cod.	pag.	Cod.	pag.	Cod.	pag.	Cod.	pag.	Cod.	pag.	Cod.	pag.
44942-05	311	44970-15	475	44991-29	104	47026-06	196	47042-19	248	47070-60	200	47106-46	187
44942-06	290	44970-20	475	44992-02	350	47027-11	196	47042-22	248	47074-01	200	47106-50	187
44942-07	290	44970-34	475	44992-03	350	47027-12	196	47042-25	248	47074-02	200	47106-55	187
44942-10	290	44972-20	475	44993-01	351	47027-13	196	47043-27	248	47074-03	200	47106-60	187
44942-11	290	44972-25	475	44994-00	350	47027-14	196	47043-35	248	47074-04	200	47106-65	187
44942-12	290	44972-33	475	44995-10	351	47027-15	196	47043-42	248	47074-05	200	47106-70	187
44944C07	298	44973-10	475	44995-14	351	47027-16	196	47060-06	206	47074-06	200	47106-75	187
44944G07	298	44973-20	475	44995-15	351	47028-12	196	47060-07	206	47074-07	200	47107-00	189
44945C05	298	44974-21	475	44997-22	104	47029-12	196	47060-09	206	47074-08	200	47108-00	189
44945G05	298	44974-27	475	44997-24	104	47030-30	197	47060-10	206	47075-20	199	47110-23	189
44946-04	416	44974-31	475	44997-26	104	47031-44	195	47060-12	206	47075-30	199	47111-30	188
44946B05	416	44975-35	207	44997-28	104	47031-46	195	47060-14	206	47075-45	199	47111-40	188
44947-00	164	44975-50	207	44998-31	104	47032-10	197	47060-16	206	47090-23	283	47111-46	188
44947-07	116	44975C50	468	44999-09	350	47032-20	197	47060-18	206	47091-01	283	47111-55	188
44948-07	301	44975H35	207	44999-16	350	47033-08	197	47060-20	206	47091-02	283	47112-34	188
44949-01	302	44975H50	207	46116-15	315	47033-12	197	47060-22	206	47093-24	116	47112-45	188
44949-02	301	44976-01	477	46118-20	363	47033-14	197	47060-24	206	47094-30	189	47112-50	188
44949-03	302	44976-02	477	46120-18	363	47033-50	194	47060-26	206	47098-18	190	47113-03	189
44949-04	302	44976-03	477	46120-22	363	47034-23	197	47060-30	206	47098-22	190	47114-40	188
44949-05	302	44976-04	476	46120-24	363	47034-50	197	47062-18	206	47098-26	190	47114-55	188
44949-06	302	44977-12	478	46123-00	364	47034-51	197	47062-20	206	47098-30	190	47118-30	188
44950-15	353	44978-10	475	46796-00	323	47034-52	197	47062-22	206	47099-30	280	47118-40	188
44950-20	353	44978-20	475	46970-18	30	47035-40	197	47063-01	206	47100-03	415	47118-55	188
44950-25	353	44979-02	476	46970-25	30	47035-48	197	47063-02	206	47100-04	415	47118-65	188
44950-30	353	44979-04	476	47005-24	209	47036-30	197	47063-05	206	47100-05	415	47119-30	187
44950-38	353	44979-05	476	47006-25	209	47036-35	197	47063-07	206	47100-06	415	47119-35	187
44960-01	269	44979-06	476	47007-26	213	47036-40	197	47063-10	206	47100-07	415	47119-40	187
44960-02	269	44982-04	248	47010-20	188	47036-45	197	47064-18	206	47100-08	415	47119-45	187
44960-03	269	44982-06	248	47011-01	201	47036-50	197	47064-22	206	47101-30	189	47119-50	187
44960-04	269	44982-10	248	47014-35	211	47036-60	197	47064-26	206	47101-31	280	47119-60	187
44960-06	269	44986-12	475	47018-30	211	47037-30	197	47064-30	206	47101-40	189	47120-01	187
44960-07	269	44986-17	475	47018-50	211	47037-40	197	47066-03	206	47103-30	189	47120-02	187
44960-10	270	44986-21	475	47020-15	187	47038-50	197	47066-04	206	47103-32	189	47127-04	184
44960-11	270	44986-28	475	47020-20	187	47038-60	197	47066-05	206	47104-45	188	47127-06	184
44960-13	270	44987-11	476	47020-30	187	47039-05	197	47066-06	206	47105-28	187	47127-08	184
44960K10	270	44987-60	476	47020-35	187	47039-10	197	47066-07	206	47105-34	187	47130-25	201
44960K11	270	44987C11	476	47021-35	187	47039-15	198	47066-08	206	47105-40	187	47130-30	201
44961-02	476	44987C60	476	47021-45	187	47040-00	248	47068-12	206	47105-46	187	47130-35	201
44961-03	269	44987C62	475	47022-12	199	47041-01	247	47068-15	206	47105-50	187	47130-40	201
44961-04	475	44990-15	310	47023-01	277	47041-02	247	47069-10	206	47105-55	187	47130-45	201
44961-05	475	44990-24	310	47023-02	277	47041-03	247	47069-12	206	47105-60	187	47130-50	201
44961-06	475	44990-29	310	47023-03	277	47041-04	247	47069-14	206	47105-65	187	47130-55	201
44961M03	269	44990-36	310	47023-04	277	47041-05	247	47069-16	206	47105-70	187	47130-60	201
44962-01	269	44990-48	310	47024-06	196	47041-06	247	47069-18	206	47105-75	187	47131-30	201
44962-05	270	44991-22	104	47024-10	196	47041-07	247	47069-20	206	47106-28	187	47131-60	201
44968-00	476	44991-24	104	47025-06	196	47041-08	247	47070-37	200	47106-34	187	47200-01	186
44970-10	475	44991-28	104	47025-10	196	47041-15	247	47070-48	200	47106-40	187	47200-02	186

**NUMERICAL INDEX INDICE NUMERICO NUMERISCH INDEX INDEX NUMERIQUE INDICE NUMERICO**

Cod.	pag.	Cod.	pag.	Cod.	pag.	Cod.	pag.	Cod.	pag.	Cod.	pag.	Cod.	pag.
47207-20	184	47308-10	169	47354-18	184	47373-02	176	47404-04	174	47511-11	203	47532-26	202
47207-25	184	47310-10	169	47355-02	184	47373-08	172	47404-08	175	47511-13	203	47533-07	202
47207-30	184	47312-10	169	47355-04	184	47374-01	175	47411-01	171	47511-15	203	47533-08	202
47208-01	183	47314-10	169	47355-06	184	47374-02	175	47411-02	171	47511-17	203	47533-09	202
47208-02	183	47315-10	169	47355-08	184	47374-08	175	47411-03	172	47511-19	203	47533-10	202
47208-03	183	47316-10	169	47355-10	184	47375-01	175	47411-08	171	47511-21	203	47533-12	202
47208-04	183	47316-12	169	47355-12	184	47375-08	175	47412-08	171	47511-23	203	47533-14	202
47208-05	183	47316-20	169	47356-02	184	47376-08	172	47413-01	171	47511-25	203	47533-16	202
47208-06	183	47317-10	169	47356-04	184	47377-01	174	47413-08	171	47511-27	203	47533-18	202
47208-07	183	47317-12	170	47356-06	184	47377-02	173	47414-03	170	47511-29	203	47533-20	202
47208-08	183	47321-12	170	47356-08	184	47377-03	173	47415-03	170	47511-31	203	47533-22	202
47208-09	183	47322-12	170	47356-10	184	47377-04	174	47416-06	170	47512-07	203	47533-24	202
47208-10	183	47323-12	170	47356-12	184	47377-05	174	47417-06	170	47512-09	203	47533-26	202
47208-11	183	47324-12	170	47356-14	184	47377-06	174	47419-10	170	47512-11	203	47533-28	202
47208-12	183	47325-10	170	47356-16	184	47377-07	174	47421-09	176	47512-13	203	47533-30	202
47208-13	183	47326-10	170	47356-18	184	47377-08	171	47422-26	176	47512-15	203	47533-32	202
47208-14	183	47327-12	170	47357-02	182	47377-09	173	47425-01	177	47512-17	203	47534-00	202
47208-15	183	47328-15	170	47357-03	182	47377-10	173	47425-02	177	47512-19	203	47534-01	202
47208-16	183	47331-15	170	47357-06	181	47377-11	174	47425-03	177	47512-21	203	47534-06	202
47208-17	184	47332-12	170	47357-07	181	47377-12	177	47425-04	177	47512-23	203	47534-07	202
47208-18	184	47333-15	170	47357-08	182	47377-15	177	47425-05	177	47512-25	203	47534-08	202
47208-19	184	47334-12	170	47357-09	182	47378-01	176	47425-06	177	47512-27	203	47534-09	202
47208-20	184	47335-12	170	47357-10	182	47378-02	176	47425-08	177	47512-29	203	47534-10	202
47208-21	184	47336-42	170	47357-11	182	47378-08	171	47425-09	177	47512-31	203	47534-16	202
47208-22	184	47350-01	183	47357-20	180	47379-08	171	47425-10	177	47526-05	204	47534-18	202
47208-23	184	47351-01	183	47357-21	180	47380-08	175	47425-11	177	47527-55	204	47534-20	202
47208-24	184	47352-01	183	47357-22	180	47381-08	176	47425-26	177	47528-05	204	47534-22	202
47212-01	186	47353-02	184	47357-24	180	47382-06	174	47425-29	177	47529-07	202	47534-24	202
47212-02	186	47353-04	184	47357-28	181	47382-08	173	47425-30	177	47530-14	202	47534-26	202
47212-03	186	47353-06	184	47357-29	181	47383-08	175	47425-32	177	47530-16	202	47534-28	202
47212-05	186	47353-08	184	47357-30	181	47384-01	175	47426-01	177	47530-18	202	47535-09	205
47214-86	185	47353-10	184	47357-31	181	47384-08	175	47426-07	177	47530-20	202	47535-12	205
47215-86	185	47353-12	184	47357-38	186	47385-01	176	47510-07	203	47530-22	202	47535-15	205
47219-29	186	47353-14	184	47357-40	185	47385-08	176	47510-09	203	47530-24	202	47535-17	205
47219-38	186	47353-16	184	47357-41	185	47386-08	175	47510-11	203	47530-26	202	47535-19	205
47219-55	186	47353-18	184	47357-42	185	47387-01	172	47510-13	203	47530-28	202	47536-12	205
47250-12	185	47353-20	184	47357-43	185	47387-02	173	47510-15	203	47530-30	202	47536-14	205
47250-24	185	47353-22	184	47357-44	185	47388-06	177	47510-17	203	47532-06	202	47536-16	205
47301-12	169	47353-24	184	47357-50	185	47388-07	177	47510-19	203	47532-07	202	47536-18	205
47302-10	169	47354-02	184	47357-51	185	47388-08	177	47510-21	203	47532-08	202	47536-20	205
47303-10	169	47354-04	184	47370-01	176	47401-08	175	47510-23	203	47532-12	202	47538-20	205
47304-06	169	47354-06	184	47370-02	176	47402-01	172	47510-25	203	47532-14	202	47538-23	205
47304-10	169	47354-08	184	47370-03	176	47402-02	172	47510-27	203	47532-16	202	47538-26	205
47304-12	169	47354-10	184	47370-08	171	47402-08	172	47510-29	203	47532-18	202	47540-02	205
47305-12	169	47354-12	184	47371-08	174	47404-01	175	47510-31	203	47532-20	202	47540-03	205
47306-10	169	47354-14	184	47372-08	172	47404-02	175	47511-07	203	47532-22	202	47540-04	205
47307-10	169	47354-16	184	47373-01	173	47404-03	175	47511-09	203	47532-24	202	47540-05	205

Cod.	pag.	Cod.	pag.	Cod.	pag.	Cod.	pag.	Cod.	pag.	Cod.	pag.	Cod.	pag.
47541-02	204	47604-30	105	47621-07	199	47655-05	215	47686-42	189	47719-10	210	47740-02	235
47541-03	204	47605-23	104	47621-08	199	47655-07	215	47687-24	189	47719-24	210	47740-03	235
47541-04	204	47606-02	105	47621-11	271	47656-01	215	47688-60	201	47720-06	211	47740-04	238
47542-00	204	47606-05	105	47621-12	271	47656-02	215	47689-53	200	47720-08	211	47740-05	238
47542-18	205	47606-10	105	47622-01	179	47656-03	215	47689-60	200	47720-10	211	47740-06	234
47542-20	205	47606-20	105	47622-02	179	47656-04	215	47691-53	200	47720-12	211	47740-07	241
47542-22	205	47606-30	105	47622-03	179	47656-05	215	47691-64	200	47721-08	212	47740-08	241
47542-24	205	47606-50	105	47622-04	178	47656-07	215	47692-01	195	47721-10	212	47740-09	239
47542-26	205	47607-10	105	47622-26	178	47657-01	215	47692-02	195	47721-12	212	47740-10	234
47544-20	204	47607-20	105	47625-03	199	47657-02	215	47692-03	195	47722-05	212	47740100	240
47544-25	204	47608-02	105	47626-55	194	47657-03	215	47693-00	195	47722-06	212	47740101	236
47544-30	204	47609-02	106	47627-01	194	47657-04	215	47693-03	195	47722-07	212	47740102	234
47546-18	204	47609-03	106	47630-28	179	47657-05	215	47693-05	195	47722-08	212	47740103	234
47546-21	205	47609-04	106	47631-08	179	47657-07	215	47693-10	195	47722-10	212	47740104	238
47546-22	205	47609-07	106	47631-12	179	47658-01	215	47693-15	195	47723-05	212	47740105	233
47546-23	205	47609-09	106	47640-25	198	47658-02	215	47694-03	192	47723-06	212	47740106	237
47546-30	204	47609-12	106	47640-35	198	47658-03	215	47698-01	193	47723-07	212	47740107	241
47546-40	204	47609-13	106	47640-50	198	47658-04	215	47698-02	193	47723-08	212	47740108	241
47546-41	205	47609-16	106	47640-59	198	47658-05	215	47698-03	193	47723-10	212	47740109	241
47546-42	205	47610-18	109	47642-30	198	47658-07	215	47698-06	193	47723-12	212	47740-11	240
47546-43	205	47610-22	109	47642-40	198	47659-01	214	47698-07	193	47724-06	212	47740110	241
47546-51	205	47610-26	109	47642-50	198	47659-02	214	47705-22	210	47724-08	212	47740111	237
47546-52	205	47610-30	109	47642-60	198	47659-03	214	47709-20	209	47724-10	212	47740112	242
47546-53	205	47611-01	110	47642-70	198	47659-04	214	47709-24	209	47724-11	212	47740113	242
47547-22	204	47611-03	110	47644-15	198	47670-02	214	47709-28	209	47725-09	212	47740114	239
47547-26	204	47611-05	110	47645-40	198	47672-05	214	47709-32	209	47726-07	211	47740115	240
47547-30	204	47611-06	110	47645-60	198	47679-10	199	47710-12	209	47727-07	211	47740116	241
47548-02	204	47611-09	110	47645-75	198	47679-11	199	47710-16	209	47728-06	211	47740117	241
47548-03	204	47611-11	110	47646-40	198	47680-40	201	47710-20	209	47730-60	212	47740119	233
47548-04	204	47611-13	110	47646-60	198	47680-53	201	47710-24	209	47731-12	213	47740-12	240
47548-05	204	47611-14	110	47646-75	198	47680-60	201	47710-28	209	47732-20	213	47740122	236
47600-16	110	47611-15	110	47651-01	215	47681-60	200	47710-32	209	47733-18	210	47740123	235
47600-20	110	47611-16	110	47651-02	215	47682-53	200	47711-08	209	47733-24	210	47740124	235
47600-24	110	47611-19	110	47651-03	215	47682-60	200	47711-12	209	47733-30	210	47740125	235
47600-28	110	47611-23	110	47651-04	215	47684-15	214	47711-22	209	47733-36	210	47740127	235
47600-32	110	47612-01	192	47651-05	215	47685-53	201	47711-24	209	47734-18	210	47740128	233
47600-36	110	47612-AA	530	47651-07	215	47685-60	201	47711-26	209	47735-18	210	47740-13	238
47600-40	110	47614-25	199	47652-01	215	47686-10	189	47712-20	209	47736-30	211	47740130	235
47603-25	104	47615-25	199	47652-02	215	47686-12	189	47712-24	209	47736-35	211	47740131	237
47603-27	104	47618-10	185	47652-03	215	47686-14	189	47712-28	209	47736-40	211	47740132	235
47604-08	105	47618-20	185	47652-04	215	47686-17	189	47712-32	209	47736-50	211	47740133	236
47604-10	105	47621-01	198	47652-05	215	47686-22	189	47713-22	209	47738-23	210	47740134	242
47604-12	105	47621-02	198	47652-07	215	47686-24	189	47714-26	210	47739-12	209	47740135	234
47604-15	105	47621-03	198	47655-01	215	47686-26	189	47714-28	210	47739-24	209	47740137	233
47604-18	105	47621-04	198	47655-02	215	47686-30	189	47715-30	210	47739-28	209	47740138	233
47604-20	105	47621-05	198	47655-03	215	47686-33	189	47717-35	210	47739-32	209	47740-14	241
47604-24	105	47621-06	198	47655-04	215	47686-36	189	47718-20	210	47740-01	240	47740142	236



**NUMERICAL INDEX INDICE NUMERICO NUMERISCH INDEX INDEX NUMERIQUE INDICE NUMERICO**

Cod.	pag.	Cod.	pag.	Cod.	pag.	Cod.	pag.	Cod.	pag.	Cod.	pag.	Cod.	pag.
47740143	236	47740-65	238	47742-05	229	47744-37	245	47756-26	214	47800-22	191	47860-31	218
47740144	236	47740-66	238	47742-06	230	47744-48	244	47756-28	214	47801-20	191	47860-35	218
47740145	239	47740-67	240	47742-07	230	47744-58	244	47757-65	211	47820-05	196	47860-36	218
47740-15	239	47740-68	237	47742-08	229	47744-59	244	47757-80	211	47820-07	196	47860-37	218
47740-16	234	47740-69	234	47742-09	229	47744-60	244	47758-10	210	47821-05	196	47860-38	218
47740-17	236	47740-70	234	47742-10	230	47744-62	244	47758-12	210	47821-07	196	47860-39	218
47740-18	234	47740-71	238	47742-12	228	47744-63	245	47759-12	211	47822-05	196	47860-40	218
47740-19	237	47740-72	238	47742-13	229	47744-70	245	47760-12	211	47822-07	196	47860-42	218
47740-20	239	47740-73	242	47742-14	229	47744-71	245	47761-23	213	47831-02	107	47860-43	218
47740-23	233	47740-74	234	47742-15	230	47744-80	244	47762-23	213	47832-00	368	47860-44	218
47740-24	239	47740-75	234	47742-16	230	47744-81	244	47764-12	214	47832-01	287	47860-46	218
47740-25	238	47740-77	236	47742-17	228	47745-02	227	47764-28	214	47832-02	368	47860-48	218
47740-26	233	47740-79	239	47742-19	229	47745-03	227	47765-24	230	47832-03	287	47860-49	218
47740-27	233	47740-80	233	47742-20	229	47745-04	227	47765-26	230	47832-04	287	47860-50	218
47740-28	233	47740-81	237	47742-21	229	47745-05	227	47765-28	230	47832-05	287	47860-53	219
47740-29	233	47740-82	236	47742-23	229	47745-06	226	47766-26	230	47832-10	368	47860-55	219
47740-30	238	47740-83	234	47742-24	230	47745-07	226	47766-28	230	47832-11	368	47860-56	219
47740-31	240	47740-84	241	47742-25	229	47745-08	226	47766-30	230	47832-12	368	47860-58	219
47740-32	237	47740-85	238	47742-27	228	47745-09	226	47769-28	231	47832-13	368	47860-60	219
47740-33	240	47740-86	241	47742-29	230	47745-10	226	47770-21	231	47832-14	368	47860-61	219
47740-34	237	47740-87	240	47742-30	228	47746-01	227	47771-28	231	47832-15	368	47860-62	219
47740-35	242	47740-88	242	47742-31	228	47746-02	227	47773-24	231	47833-04	179	47860-63	219
47740-36	239	47740-89	235	47742-33	229	47746-03	227	47773-28	231	47833-10	179	47860-66	219
47740-37	235	47740-90	240	47742-34	229	47746-04	227	47783-01	216	47837-09	179	47860-67	219
47740-38	235	47740-91	240	47742-37	229	47747-01	212	47783-02	216	47838-00	193	47860-68	219
47740-39	238	47740-92	237	47742-41	228	47747-03	212	47783-03	216	47840-11	193	47860-69	219
47740-41	235	47740-93	233	47742-42	229	47747-04	212	47783-04	216	47841-03	193	47860-70	219
47740-43	234	47740-94	236	47742-47	230	47747-05	213	47783-11	216	47841-04	193	47860-71	219
47740-44	237	47740-95	235	47742-48	230	47747-06	212	47783-12	216	47842-00	194	47860-73	219
47740-45	238	47740-96	241	47742-51	228	47747-07	213	47783-13	216	47843-00	127	47860-74	219
47740-46	237	47740-97	236	47742-56	228	47747-09	213	47783-14	216	47843-05	127	47860-75	220
47740-47	237	47740-98	240	47742-61	230	47747-10	212	47793-11	225	47844-01	192	47860-76	223
47740-48	237	47740-99	239	47743-03	242	47747-11	212	47793-12	225	47844-02	192	47860-77	223
47740-49	237	47741-00	243	47743-05	242	47748-35	213	47793-13	225	47844-06	192	47860-78	223
47740-50	236	47741-01	243	47743-10	242	47749-35	213	47793-15	225	47846-10	192	47860-81	220
47740-51	239	47741-02	243	47743-13	242	47750-06	213	47793-16	225	47847-10	192	47860-83	220
47740-52	234	47741-05	243	47743-15	243	47752-09	211	47793-18	225	47847-12	192	47860-84	220
47740-53	242	47741-37	244	47743-16	243	47752-16	211	47793-20	225	47847-23	192	47860-85	220
47740-55	238	47741-38	244	47743-65	243	47752-21	211	47793-23	225	47848-07	192	47860-86	223
47740-56	239	47741-76	243	47744-10	244	47753-31	211	47793-26	225	47859-01	276	47860-90	223
47740-57	234	47741-77	243	47744-19	244	47754-20	214	47793-32	225	47859-02	276	47860-95	220
47740-58	234	47741-78	243	47744-21	245	47754-24	214	47793-33	225	47859-03	276	47860-96	220
47740-59	234	47742-00	231	47744-30	243	47754-26	214	47793-40	225	47860-17	217	47861-02	217
47740-60	234	47742-01	230	47744-31	244	47754-28	214	47793-43	225	47860-18	218	47861-03	217
47740-62	238	47742-02	228	47744-32	243	47755-26	214	47793-45	225	47860-21	218	47861-04	217
47740-63	239	47742-03	230	47744-34	244	47756-20	214	47793-52	225	47860-24	218	47861-05	217
47740-64	238	47742-04	230	47744-36	245	47756-24	214	47793-55	225	47860-27	218	47861-06	217

Cod.	pag.	Cod.	pag.	Cod.	pag.	Cod.	pag.	Cod.	pag.	Cod.	pag.	Cod.	pag.
47861-07	217	47862-89	224	48220-00	123	48278-20	90	48278-89	94	48280-61	87	48313-14	303
47861-08	217	47862C10	222	48222-01	123	48278-21	90	48278-91	92	48280-62	87	48313-18	303
47861-09	217	47865-23	224	48223-00	325	48278-24	88	48278-92	92	48280-63	87	48313-20	303
47861-10	217	47865-44	224	48231-40	162	48278-25	91	48278-93	93	48280-75	85	48350-01	292
47861-11	217	47865-66	224	48231-45	162	48278-27	93	48278-94	90	48280-85	86	48350-02	292
47861-12	217	47865-71	224	48231-50	162	48278-28	94	48278-95	91	48280-90	88	48350-03	292
47861-13	217	47865-72	224	48232-40	530	48278-31	90	48278-96	91	48280-91	87	48350-04	292
47861-14	217	47865-73	224	48232-45	530	48278-32	88	48278-99	92	48280-92	88	48351-01	293
47861-15	217	47865-74	224	48232-50	530	48278-33	88	48280-02	86	48280-94	85	48351-02	293
47861-16	223	47865-75	224	48236-00	355	48278-34	91	48280-03	86	48280-95	88	48351-03	293
47862-03	221	47865-76	224	48236-01	355	48278-35	91	48280-04	84	48280-96	87	48352-01	293
47862-04	221	47865-77	224	48237-00	355	48278-36	92	48280-05	84	48280-97	87	48352-02	293
47862-05	221	47865-80	224	48237-01	355	48278-37	90	48280-06	85	48281-22	117	48352-03	293
47862-06	222	47865-81	224	48237-35	355	48278-38	88	48280-08	87	48281-23	117	48353-01	292
47862-07	222	47865-82	224	48237-99	355	48278-39	88	48280-09	85	48282-21	118	48354-01	292
47862-08	222	47865-83	224	48238-00	361	48278-41	89	48280-10	86	48286-03	120	48355-01	336
47862-09	222	47870-17	223	48239-00	361	48278-42	89	48280-11	87	48286-08	120	48356-01	336
47862-10	222	47870-18	223	48240-00	361	48278-45	90	48280-12	85	48286-13	120	48357-01	336
47862-31	220	47870-19	223	48241-14	370	48278-46	89	48280-13	85	48286-62	116	48358-01	336
47862-32	220	47875-11	216	48242-09	369	48278-47	91	48280-15	87	48286-64	116	48359-01	336
47862-33	220	47875-13	216	48244-04	369	48278-48	89	48280-20	84	48286-67	86	48362-01	326
47862-34	220	47875-14	216	48244-07	369	48278-49	89	48280-21	84	48286-68	361	48363-01	326
47862-35	220	47876-11	224	48245-10	370	48278-52	91	48280-23	88	48286-70	119	48364-09	326
47862-36	220	47876-12	224	48245-75	370	48278-53	91	48280-24	86	48287-18	368	48364-12	326
47862-38	220	47876-13	224	48247-10	369	48278-54	91	48280-25	88	48287-19	368	48365-09	292
47862-39	220	47876-14	224	48249-13	369	48278-55	89	48280-26	86	48288-02	116	48366-09	292
47862-64	221	47885-01	121	48250-10	369	48278-61	92	48280-27	157	48288-03	116	48367-10	291
47862-65	221	47885-02	121	48250-12	369	48278-62	92	48280-30	86	48289-10	115	48368-05	335
47862-66	221	47885-03	121	48251-03	369	48278-63	93	48280-31	86	48290-10	248	48368-12	335
47862-67	221	47885-04	121	48252-10	369	48278-64	92	48280-32	84	48294-01	121	48368-20	335
47862-70	222	47885-05	121	48252-12	369	48278-65	93	48280-34	87	48294-02	121	48369-08	335
47862-71	222	48017-14	151	48252B10	369	48278-66	92	48280-35	86	48294-03	121	48369-14	335
47862-72	222	48017-25	151	48252B12	369	48278-68	92	48280-36	86	48294-04	121	48369-20	335
47862-73	222	48021-21	151	48253-09	369	48278-69	92	48280-37	85	48295-10	118	48370-10	292
47862-74	222	48032-30	159	48253B09	369	48278-71	93	48280-38	84	48300-29	256	48370-11	292
47862-75	222	48032-45	159	48278-01	90	48278-73	93	48280-39	84	48300-33	256	48371-10	291
47862-76	222	48032-60	159	48278-02	91	48278-74	93	48280-41	85	48300-42	256	48371-11	291
47862-77	222	48039-06	159	48278-03	91	48278-75	90	48280-45	84	48300-43	256	48372-08	336
47862-80	224	48040-00	159	48278-11	92	48278-76	93	48280-46	85	48306-01	326	48373-06	291
47862-81	224	48040-10	159	48278-12	89	48278-77	90	48280-47	87	48307-01	160	48373-09	291
47862-82	224	48040-50	159	48278-13	89	48278-81	94	48280-48	84	48307-02	160	48373-12	291
47862-83	224	48040-AA	530	48278-14	94	48278-82	94	48280-49	85	48307-03	160	48373-17	291
47862-84	224	48210-00	361	48278-15	92	48278-83	94	48280-52	87	48310-14	303	48501-76	166
47862-85	224	48211-00	361	48278-16	92	48278-84	93	48280-53	87	48310-20	303	48505-01	166
47862-86	224	48215-14	151	48278-17	91	48278-85	94	48280-54	86	48311-20	303	48505-02	166
47862-87	224	48215-30	151	48278-18	94	48278-87	90	48280-59	85	48311-25	303	48505-03	166
47862-88	224	48218-00	115	48278-19	94	48278-88	93	48280-60	87	48312-25	303	48506-01	166

**NUMERICAL INDEX INDICE NUMERICO NUMERISCH INDEX INDEX NUMERIQUE INDICE NUMERICO**

Cod.	pag.	Cod.	pag.	Cod.	pag.	Cod.	pag.	Cod.	pag.	Cod.	pag.	Cod.	pag.
48506-02	166	49384-03	472	49614-28	260	49655-23	252	49657-15	260	49750-00	115	49829-11	118
48506-03	166	49384-04	472	49615-01	261	49655-24	252	49657-20	260	49752-00	119	49829-BA	531
48510-00	166	49384-05	472	49616-22	260	49655-25	254	49657-25	260	49753-06	119	49830-00	531
48511-02	167	49384-06	472	49616-24	260	49655-26	254	49658-01	255	49753-09	119	49830-02	531
48512-02	167	49384-07	472	49616-26	260	49655-27	255	49658-02	256	49755-10	119	49830-60	119
48513-02	167	49384-11	472	49616B01	261	49655-28	255	49659-24	259	49760-00	113	49830-AA	531
48514-00	166	49384-14	472	49616S01	261	49655-29	253	49659-26	259	49771-00	134	49830-AB	531
48516-07	167	49384-15	472	49617-23	262	49655-30	256	49660-09	258	49772-01	134	49830-AC	531
48516-08	167	49600-00	259	49617-25	262	49655-31	252	49660-13	258	49773-05	134	49831-10	117
48516-09	167	49601-14	262	49617-30	262	49655-32	252	49661-22	258	49774-05	134	49832-02	117
48517-03	167	49602-25	259	49618-12	261	49655-34	252	49661-24	258	49775-05	134	49832-10	117
48518-01	167	49602-30	259	49618-15	261	49655-35	253	49662-40	258	49775-10	134	49832-80	531
48518-02	167	49602-33	259	49618-18	261	49655-36	252	49662-50	258	49776-15	135	49832-86	531
48523-01	167	49602-35	259	49626-00	257	49655-37	252	49663-22	258	49776-30	135	49832-88	531
48523-02	167	49603-15	257	49626-02	257	49655-38	260	49663-24	258	49777-50	134	49832-90	531
48523-03	167	49603-20	257	49627-22	256	49655-40	259	49664-01	256	49779-15	135	49832-96	531
48523-04	167	49603-25	257	49628-00	256	49655-41	252	49664-02	256	49779-30	135	49832-98	531
48543-01	320	49603-30	257	49629-45	262	49655-42	254	49664-03	256	49790-09	452	49832-99	531
48543-02	320	49603-40	257	49630-06	500	49655-43	254	49664-04	256	49801-04	496	49833-00	421
49304-06	469	49603-50	257	49632-24	261	49655-44	252	49664-05	256	49801-06	496	49834-00	115
49335-01	486	49604-31	258	49632-32	261	49655-45	253	49701-00	128	49802-04	496	49834-01	531
49335-02	486	49604-36	258	49633-22	261	49655-46	252	49702-00	128	49802-06	496	49834-02	531
49336-00	486	49604-41	258	49633-24	261	49655-49	258	49703-00	131	49803-02	496	49835-00	115
49336-02	486	49605-46	259	49634-00	262	49655-50	258	49703-01	194	49806-00	497	49835-01	531
49337-00	486	49605-61	259	49635-00	262	49655-51	254	49705-00	127	49808-00	504	49835-02	531
49337-01	486	49605-71	259	49636-00	154	49655-52	254	49709-03	22	49809-00	501	49836-00	115
49371-09	493	49606-00	261	49637-00	262	49655-53	254	49710-00	128	49811-00	125	49837-05	114
49371-12	493	49606-01	261	49638-00	262	49655-54	254	49711-00	129	49811-01	530	49837-AA	531
49373-01	472	49606-51	261	49652-10	259	49655-55	254	49712-00	127	49811-02	530	49838-08	114
49373-02	472	49607-15	262	49652-12	259	49655-56	254	49715-00	128	49812-00	125	49838-98	114
49373-03	472	49607-20	262	49652-15	259	49655-57	254	49716-00	128	49812-01	530	49838-AB	532
49373-04	472	49607-25	262	49652-17	259	49655-58	254	49717-00	129	49814-00	125	49839-00	113
49373-05	493	49607-30	262	49652-20	259	49655-60	254	49719-00	130	49814-01	530	49842-00	114
49373-11	472	49608-15	262	49653-10	259	49655-61	255	49720-00	131	49815-00	125	49843-05	123
49373-12	472	49608-20	262	49653-12	259	49655-64	259	49721-03	131	49818-00	114	49844-01	123
49373-13	472	49608-25	262	49653-15	259	49655-66	260	49723-00	132	49818-AC	114	49845-01	113
49373-14	472	49608-30	262	49653-17	259	49655-70	254	49729-00	129	49818-AD	114	49846-05	450
49373-90	472	49608-35	262	49653-20	259	49655-72	255	49730-00	131	49818-AE	114	49846-09	450
49378-00	484	49609-12	262	49654-15	259	49655-80	255	49730-20	131	49818-AF	114	49846-15	450
49378-48	493	49609-14	262	49654-20	259	49655-81	255	49731-10	132	49820-05	113	49847-08	452
49379-00	484	49610-11	262	49654-25	259	49655-86	255	49731-99	131	49821-08	114	49847-38	452
49381-01	470	49610-14	262	49655-02	257	49655-87	255	49733-00	130	49823-00	119	49850-03	502
49381-02	472	49612-30	259	49655-03	257	49655-88	255	49734-00	131	49823-89	120	49850-06	500
49381-03	472	49612-33	259	49655-10	257	49656-02	260	49735-00	131	49823-99	120	49850-10	500
49382-10	472	49613-30	259	49655-16	257	49656-15	257	49739-00	159	49827-03	120	49850-11	498
49382-23	472	49613-33	259	49655-21	252	49656-16	257	49741-07	517	49827-77	119	49850-13	498
49382-47	472	49613-35	259	49655-22	252	49656-20	257	49741-15	517	49827-99	119	49850-14	498

Cod.	pag.	Cod.	pag.	Cod.	pag.	Cod.	pag.	Cod.	pag.	Cod.	pag.
49850-18	497	49871-20	517	49911-30	504	49942-03	505	49978-10	163	66324-50	419
49850-19	497	49872-00	517	49911-35	504	49943-01	505	49978-13	163	66324-65	419
49850-20	496	49875-06	159	49911-45	504	49943-02	505	49979-03	501	66324-85	419
49850-21	497	49876-03	163	49916-25	504	49944-01	505	49986-00	129	66324-99	419
49850-22	496	49879-37	123	49916-35	504	49944-02	505	49987-00	129	66325-30	419
49850-23	497	49879-90	532	49916-45	504	49945-05	509	49988-00	129	66325-35	419
49850-24	502	49879-91	532	49916-55	504	49946-01	506	49993-01	502	66325-41	419
49850-25	502	49879-92	532	49921-00	515	49947-08	509	49993-02	502	66325-46	419
49850-26	502	49879-93	532	49922-01	506	49949-09	507	49993-03	502	66325-54	419
49850-27	502	49879-94	532	49922-02	506	49949-19	500	49993-11	503	66325-85	419
49850-33	498	49880-10	130	49922-03	506	49949-20	504	49993-12	503	66325-99	419
49850-36	498	49880-11	130	49922-04	506	49952-08	510	49993-13	503	66326-30	419
49850-37	499	49880-12	130	49922-06	506	49953-02	501	49993-21	502	66326-35	419
49850-41	499	49880-13	130	49922-08	507	49954-18	509	49993-22	502	66326-40	419
49850-42	499	49880-14	130	49922-09	507	49954-20	509	49993-23	502	66326-60	419
49850-43	500	49880-15	130	49922-20	507	49954-21	508	49995-04	461	66326-80	419
49850-44	500	49880-17	22	49922-21	507	49954-22	510	49996-00	462	66339-02	279
49850-61	498	49881-01	130	49922-22	507	49955-01	508	49996-01	462	66345-55	419
49850-63	501	49881-02	130	49922-23	507	49956-01	508	49996-05	462	66345-65	419
49850-65	496	49881-11	130	49923-00	315	49956-AA	532	49997-12	509	66345-74	419
49850-70	500	49881-12	130	49923-01	316	49957-00	508	49997-13	509	66362-02	356
49850-71	497	49881-99	130	49923-02	316	49958-00	507	49998-20	511	66374-00	278
49850-73	499	49883-00	128	49923-99	316	49959-00	508	49998-35	511	66391-00	278
49850-75	499	49884-08	129	49924-21	316	49960-00	508	49999-04	442	67303-64	278
49850-76	499	49885-02	127	49924-31	316	49971-25	163	52550F63	523	67303M01	253
49851-10	510	49887-00	127	49924-36	316	49971M25	163	52550F73	523	67303M02	253
49854-03	448	49887-02	128	49931-00	491	49971P25	163	52550F78	523	67303M03	253
49854-06	449	49888-10	111	49931-60	491	49971R00	163	52550F80	523	67303M04	253
49855-05	448	49888-20	111	49931-64	491	49971R25	163	52550F88	523	67303M05	253
49855-10	449	49889-09	109	49931-87	491	49972-30	163	66303-01	277	67303M06	253
49855-15	449	49889-12	109	49931A00	491	49972M30	163	66303-03	277	67303M07	254
49856-04	448	49889-15	109	49931B01	491	49972P30	163	66303-06	277	67303Q80	253
49858-00	324	49892-40	493	49931B02	491	49972R30	163	66307-06	277	67303Q81	253
49858-01	324	49897-09	493	49931B03	491	49974-25	516	66307-09	277	67303Q82	253
49858-06	325	49898-30	493	49931B05	491	49974-30	516	66307-12	277	67303Q83	253
49858-07	324	49899-01	492	49931C04	491	49974U25	516	66313-03	277	67305-57	253
49858-AA	532	49899-91	492	49933-30	492	49974U30	516	66313-06	278	67308-57	253
49860-00	325	49899-92	492	49933-50	492	49975-19	515	66318-19	279	XO1046	532
49864-03	134	49899-93	492	49933-68	492	49975-22	516	66318-22	279		
49864-05	134	49899-94	492	49934-04	492	49975-25	515	66320-28	419		
49864-20	134	49899-95	492	49934-06	492	49975-30	516	66320-35	419		
49865-06	133	49899-AA	532	49934-08	492	49975-35	516	66320-40	419		
49865-70	133	49907-01	503	49934-14	493	49975U19	515	66320-50	419		
49867-01	125	49907-06	503	49934-16	493	49975U22	516	66320-65	419		
49867-02	125	49907-AA	504	49934-18	493	49975U25	515	66320-85	419		
49870-AA	532	49911-19	504	49940-01	504	49975U30	516	66320-99	419		
49871-10	517	49911-24	504	49942-01	505	49975U35	516	66324-40	419		



# SALES CONDITIONS

CONDIZIONI DI VENDITA

LIEFERBEDINGUNGEN

CONDITIONS DE VENTE

CONDICIONES DE VENTA

## ENG

### General Sales Terms & Conditions

- All orders are subject to approval and acceptance by Sambonet Paderno Industrie S.p.A.
- Minimum order € 100,00 net.
- Standard packaging included in the price.
- These general sales terms & conditions may be modified only by an agreement in writing.

### Ownership & Payment Terms

- All goods remain the sole property of the Sambonet Paderno Industrie S.p.A. until payment has been made in full.
- Title to the ownership of any delivered good shall be transferred to the client upon full payment of the price set forth in the invoice. Payment becomes due within the payment term agreed upon by the parties. Should any amount to be paid by the client become overdue, the client shall pay a late payment interest pursuant to art. 5 D.L.G.S. 231/2002, as subsequently amended pursuant D.L.G.S. 192/2012, plus an 8% interest rate.

### Offers/Orders

- Any offer of Sambonet Paderno Industrie S.p.A shall not be binding.
- The written acceptance of any offer, or the order confirmation (according to the sales conditions included in it), constitutes a valid purchase order in accordance with the general sales terms & conditions, for all the purposes thereof.

### Returns/Complaints

- Goods must be inspected at the time of delivery.
- Should any good be damaged or defected, the waybill shall be signed with reserve, specifying the relevant reason (pictures of the good displaying the batch number, the courier and a description of the defect must be presented).
- Product returns must be made within 15 days of invoice date, subject to the following conditions:
  - claims and complaints must be made through the guided procedure available on our website, [www.agenti.sambonet.it](http://www.agenti.sambonet.it), under the user section;
  - Goods are delivered ex works - at our premises in Orfengo;
  - in case of customer liability, Sambonet Paderno Industrie S.p.A. will charge 15% of the net value of the goods, with a minimum of € 25.00 for handling charges;
  - in case goods are returned due to our fault, Sambonet Paderno Industrie S.p.A. will replace them free of charge;
  - client will be responsible for all shipping costs for products purchased out of warranty that need to be returned for repairs;
  - customized (not included in our catalogue), Tailor Made engraved, with extra personalization and discontinued items cannot be returned.

### Order Cancellation

- Cancellation is not allowed in case of discontinued, custom designed, and non-stock items.
- Catalogue items can be cancelled only if the purchase order has not yet been confirmed.

### Delivery Terms – Group A

*Austria, Germany, Netherlands, Belgium, Luxembourg, France, UK:*

- Goods are delivered at client's place:
  - with a charge of € 15.00 for orders with a net value between € 100.00 and € 350.00;
  - free of change for orders with a net value over € 350,00.
- Above delivery terms are valid only for shipments executed through our fixed forwarding agent.

### Delivery Terms – Group B

*Spain, Portugal, Poland, Czech Republic, Slovakia, Hungary, Romania, Slovenia, Croatia, Bulgaria, Denmark, Norway:*

- Goods are delivered at client's place:
  - with a charge of € 30.00 for orders with a net value between € 100.00 and € 600.00;
  - free of change for orders with a net value over € 600,00.
- Above delivery terms are valid only for shipments executed through our fixed forwarding agent.

### Delivery Terms – Group C

*Greece, Ireland, Latvia, Lithuania, Estonia, Sweden, Finland:*

- Goods are delivered at client's place:
  - with a charge of € 50.00 for orders with a net value between € 100.00 and € 1,000.00;
  - free of change for orders with a net value over € 1,000,00.
- Above delivery terms are valid only for shipments executed through our fixed forwarding agent.

### Delivery Terms – Group D

*EU and Extra-EU countries not specified in the previous paragraphs:*

- Goods are delivered ex works.

### Personalisations (The costs indicated are net)

- Sambonet Paderno Industrie S.p.A. makes customizations and special executions at the customer's request under the following conditions:
  - advance payment of 30%** on the value of the order;
  - delivery to be agreed after approval of the executive design and/or the sample;
  - Sambonet Paderno Industrie S.p.A. reserves the right to apply a **tolerance** in quantity of +/- 10% (rounded up) for each item ordered;
  - Sambonet Paderno Industrie S.p.A. shall provide the Customer with a form indicating all the necessary parameters (design, position, dimensions, etc.) and shall proceed with the supply only upon receipt of the same signed for acceptance.
- Sawing of fruit knife blades: if not standard, € 0.65 per piece will be charged.
- Pantograph/Laser engraving:
  - plant cost: € 70.00;
  - engraving cost: cutlery € 0.50 per piece – holloware € 1.00 per piece.
  - minimum quantities: cutlery 100 pcs – holloware 10 pcs.
- Stamping:
  - die costs: € 300.00 for the first die - additional dies € 150.00 each;
  - stamping costs: cutlery € 0.50 per piece - holloware will be quoted upon request;
  - minimum quantities:
    - first order: cutlery 1,000 pieces per item - hollow handle knives 800 pieces per item;
    - for further orders: cutlery 100 pieces per item - hollow handle knives 800 pieces per item.

### Sambonet Tailor Made personalizations (The costs indicated are net)

- Type of standard Tailor Made engravings:
  - On the front terminal: one of the standard logos, or the monogram (two letters) using one of the standard characters;
  - On the rear terminal: the date in the standard format, using one of the standard characters;
- Tailor Made engraving cost:
  - € 19.90 for engravings on the front terminal;
  - € 19.90 for engravings on the rear terminal;
  - € 39.80 for engraving on both the front and rear terminals.
- Minimum purchase order for Tailor Made loose items:
  - 6 pcs for nickel-silver items, multiples of 6 pcs;
  - 12 pcs for all other items, multiples of 12 pcs.
- Application of the Tailor Made engraving cost on the single purchase order:
  - A single cost per type of engraving, as set out in point 2;
  - A single cost regardless of the number of pcs, if higher than the minimum purchase indicated in point 3;
  - One cost regardless of the number of pcs up to 150 pcs.
  - Above 150 pcs and at multiples of 150 pcs the cost of engraving will be applied again.

### Special conditions for personalisations

- The Company reserves the right not to carry out the customization if it considers it not technically executable.
- Customized orders and special executions cannot be cancelled.
- Customized products cannot be returned for replacement.
- Requests for specific packaging will be charged to the Customer.

### Marketing

- The goods are intended for marketing in the Country where the customer is based. If the goods are sold in a different Country, the client shall undertake to verify the regulations applicable to the goods in such Country, including customs and import rules, as well as the risk of disputes by third parties for an reason whatsoever. It being understood that the client shall hold Sambonet Paderno Industrie S.p.A. free and harmless of any claim and/or legal action from third parties arising by the sale of the goods in such different Country.
- Sambonet Paderno Industrie S.p.A. does not provide any guarantee regarding possible infringement of intellectual property rights of third parties, in particular in the event of resale of the goods over the internet.
- It is prohibited to publish prices lower than the price lists in force on websites without authentication.

### Retention of title and payment terms

- Any complaints shall not in any case have the effect of deferring or suspending payments.
- Any payment delays shall therefore render the Customer a debtor by law to Sambonet Paderno Industrie S.p.A. of a lump sum indemnity for reminder costs of € 40.00. If the reminder costs exceed the aforementioned amount, Sambonet Paderno Industrie S.p.A. will have the right to claim a further indemnity.
- In the event of non-payment of all or part of the invoice, or of any deterioration in the Customer's financial situation, Sambonet Paderno Industrie S.p.A. will also have the right to:
  - suspend or cancel the orders and deliveries in progress;
  - request advance payment for further orders and/or payment guarantees.

### Delivery

- The delivery deadlines are indicated as accurately as possible but they depend upon the procurement and transportation conditions of Sambonet Paderno Industrie S.p.A., which undertakes to apply the utmost diligence in order to respect the deliveries, subject to causes of force majeure.
- If the planned delivery deadlines are exceeded, Sambonet Paderno Industrie S.p.A. shall not be required to pay any penalty, damages compensation or interest.
- Any change to the order will lead to a consequent change to the delivery date.
- The following are considered to be causes of force majeure, which release Sambonet Paderno Industrie S.p.A. from the delivery obligation: war, revolt, fire, strikes, impossibility of procurement, particularly significant incidents involving equipment, machine breakdowns, interruption or delay in transportation.
- Sambonet Paderno Industrie S.p.A. will keep the Customer informed of any delay. In any case, the delivery within the deadlines may only be made if the Customer has precisely fulfilled all its obligations towards Sambonet Paderno Industrie S.p.A., whatever the cause.
- It is, moreover, agreed between the parties that if the Customer does not take possession of the ordered products under the established conditions, Sambonet Paderno Industrie S.p.A. will invoice to the Customer:
  - any additional transportation and/or storage cost;
  - custody costs equivalent to 5% of the order amount, excluding taxes, for each month of delay.

### Important notice

- The perception of colour may be subjective, in function of geometries, dimensions, finishes, and lighting in the environment. The products subject to PVD processing may manifest slight chromatic variations or diversities between different models, series or batches of the same product. These variations are acceptable if within the established tolerance limits, which are strictly monitored.
- Errors may occur during the printing stage. Sambonet Paderno Industrie S.p.A. reserves the right to correct printing or calculation errors.
- The pictures illustrated and data are representatives. Sambonet Paderno Industrie S.p.A. reserves the right to alter at any time the specifications stated without notice.
- The shapes of cutlery illustrated in this publication are representatives and are not to be considered as the real shape.

**Condizioni Generali e Termini di Vendita**

1. Gli ordini sono soggetti ad approvazione di Sambonet Paderno Industrie S.p.A.
2. Ordine minimo € 100,00 netto merce.
3. Imballo standard gratuito.
4. Qualsiasi variazione delle presenti condizioni richiede la forma scritta.

**Diritto di Proprietà e Condizioni di Pagamento**

1. La merce fornita rimane di proprietà di Sambonet Paderno Industrie S.p.A. fino all'integrale pagamento della fattura da parte del cliente.
2. Il pagamento della fattura è dovuto entro il termine di pagamento preventivamente concordato tra le parti. Allo scadere di tale termine, saranno dovuti gli interessi di mora al saggio di cui all'art.5 D.LGS. 231/2002 e succ. modifiche come da D.LGS. 192/2012, maggiorato dell'8%.

**Offerte/Ordini**

1. Le offerte di Sambonet Paderno Industrie S.p.A. sono libere e non vincolanti all'ordine.
2. Con l'accettazione dell'offerta in forma scritta o della conferma d'ordine (con le modalità in essa contenute), si genera a tutti gli effetti un ordine che comporta l'esecuzione di un contratto conforme alle condizioni generali e termini di vendita.

**Resi/Reclami**

1. La merce deve essere controllata al ricevimento.
2. In caso di colli difettosi/danneggiati, il documento di trasporto dovrà essere firmato con riserva, specificando i motivi (vale come prova la foto del collo con evidenza del segnacollo e nastro del corriere e descrizione del difetto).
3. I reclami saranno accettati entro **15 giorni** dalla data fattura, termine ultimo non negoziabile, alle seguenti condizioni:
  - a) la segnalazione di reclamo / richiesta di reso merce deve essere fatta attraverso la procedura guidata all'indirizzo [www.agenti.sambonet.it](http://www.agenti.sambonet.it) nell'area utente;
  - b) la merce dovrà essere resa franco nostra fabbrica;
  - c) In caso di responsabilità del cliente, Sambonet Paderno Industrie S.p.A. provvederà all'addebito del 15% del prezzo netto, con un minimo di € 25,00, per costi di gestione;
  - d) in caso di accertata responsabilità di Sambonet Paderno Industrie S.p.A., la merce verrà sostituita, e resa franco domicilio cliente;
  - e) per prodotti resi per riparazione non in garanzia, le spese di spedizione e rispedizione, sono a carico del cliente;
  - f) Non saranno accettati resi per articoli speciali (non a catalogo), incisi Tailor Made, con altre personalizzazioni o fuori produzione.

**Annullamento dell'ordine**

1. Per i prodotti fuori catalogo, personalizzati o speciali NON è possibile annullare l'ordine.
2. Per i prodotti a catalogo, l'annullamento è possibile solo se l'ordine non è ancora stato confermato.

**Condizioni di Resa Italia**

1. La merce è resa franco domicilio Cliente tramite corriere convenzionato con Sambonet Paderno Industrie S.p.A.:
  - a) con addebito forfettario di € 15,00 (spese di gestione ordine) per ordini da € 100,00 a € 350,00 netto merce;
  - b) senza alcun addebito per ordini superiori a € 350,00 netto merce.
2. Qualora il Cliente richieda che le spedizioni vengano effettuate tramite Suo corriere di fiducia, le merci verranno inoltrate automaticamente in franco fabbrica:
  - a) con addebito forfettario di € 15,00 (spese di gestione ordine) per ordini da € 100,00 a € 350,00 netto merce;
  - b) senza alcun addebito per ordini superiori a € 350,00 netto merce.
3. Per ogni contestazione o controversia è applicabile la legge Italiana e competente il Foro di Novara.

**Condizioni di Resa – Gruppo A**

*Austria, Germania, Olanda, Belgio, Lussemburgo, Francia, UK:*

1. La merce è resa franco domicilio Cliente:
  - a) con addebito di € 15,00 per ordini da € 100,00 a € 350,00 netto merce;
  - b) senza alcun addebito per ordini superiori a € 350,00 netto merce.
2. Le condizioni sopra indicate sono valide solo per spedizioni tramite corriere convenzionato con Sambonet Paderno Industrie S.p.A.

**Condizioni di Resa – Gruppo B**

*Spagna, Portogallo, Polonia, Repubblica Ceca, Slovacchia, Ungheria, Romania, Slovenia, Croazia, Bulgaria, Danimarca, Norvegia:*

1. La merce è resa franco domicilio Cliente:
  - a) con addebito di € 30,00 per ordini da € 100,00 a € 600,00 netto merce;
  - b) senza alcun addebito per ordini superiori a € 600,00 netto merce.
2. Le condizioni sopra indicate sono valide solo per spedizioni tramite corriere convenzionato con Sambonet Paderno Industrie S.p.A.

**Condizioni di Resa – Gruppo C**

*Grecia, Irlanda, Lettonia, Lituania, Estonia, Svezia, Finlandia:*

1. La merce è resa franco domicilio Cliente:
  - a) con addebito di € 50,00 per ordini da € 100,00 a € 1.000,00 netto merce;
  - b) senza alcun addebito per ordini superiori a € 1.000,00 netto merce.
2. Le condizioni sopra indicate sono valide solo per spedizioni tramite corriere convenzionato con Sambonet Paderno Industrie S.p.A.

**Condizioni di Resa – Gruppo D**

*Nazioni UE ed Extra-UE non specificate nei paragrafi precedenti:*

1. La merce è resa franco fabbrica.

**Personalizzazioni (I costi indicati sono da intendersi netti)**

1. Sambonet Paderno Industrie S.p.A. effettua su richiesta del Cliente personalizzazioni ed esecuzioni particolari alle seguenti condizioni:
  - a) versamento di **acconto del 30%** sul valore dell'ordine;
  - b) consegna da convenire dopo l'approvazione disegno esecutivo e/o campione;
  - c) Sambonet Paderno Industrie S.p.A. si riserva la facoltà di applicare, per ogni singolo articolo, una **tolleranza** pari a +/- 10%, con arrotondamento all'unità superiore, nella spedizione dei quantitativi ordinati;
  - d) Sambonet Paderno Industrie S.p.A. provvederà a fornire al Cliente una scheda con l'indicazione di tutti i parametri necessari (disegno, posizione, dimensioni, ecc.) e procederà alla fornitura solo al ricevimento della stessa firmata per accettazione.
2. Seghettatura lame coltelli frutta: ove non prevista di serie, con addebito di € 0,65 al pezzo.
3. Incisione al Pantografo/Laser:
  - a) costo impianto: € 70,00;
  - b) costo incisione: posateria € 0,50 al pezzo - vasellame, incisione ove possibile, € 1,00 al pezzo;
  - c) quantità minime: posateria 100 pezzi per articolo - vasellame 10 pezzi per articolo.
4. Punzonatura:
  - a) costo punzoni: il primo punzone € 300,00 - i successivi € 150,00 cad.;
  - b) costo punzonatura: posateria € 0,50 al pezzo - vasellame preventivo su richiesta;
  - c) quantità minime:
    - nuovi impianti: posateria 1.000 pezzi per articolo - coltelli manico cavo 800 pezzi per articolo;
    - riordini: posateria 100 pezzi per articolo - coltelli manico cavo 800 pezzi per articolo.

**Personalizzazioni Sambonet Tailor Made (I costi indicati sono da intendersi netti)**

1. Tipologia di incisioni Tailor Made standard:
  - a) Sul terminale frontale: uno dei loghi standard, oppure il monogramma (due lettere) utilizzando uno dei caratteri standard;
  - b) Sul terminale posteriore: la data in formato standard, utilizzando uno dei caratteri standard;
2. Costo di incisione Tailor Made:
  - a) € 19,90 per incisioni sul terminale frontale;
  - b) € 19,90 per incisioni sul terminale posteriore;
  - c) € 39,80 per incisioni sul terminale frontale e sul terminale posteriore.
3. Ordine minimo di acquisto per articoli sfusi Tailor Made:
  - a) 6 pz per le referenze realizzate in alpacca, a multipli di 6 pz;
  - b) 12 pz per tutte le altre referenze, a multipli di 12 pz;
4. Applicazione del costo di incisione Tailor Made sul singolo ordine di acquisto:
  - a) Un solo costo per ogni tipologia di incisione - indicate al punto 2;
  - b) Un solo costo a prescindere dal numero di referenze - se superiori al minimo di acquisto indicato al punto 3;
  - c) Un solo costo a prescindere dal numero di pz fino a 150 pz.
  - d) Oltre i 150 pz e a multipli di 150 pz verrà nuovamente applicato il costo di incisione.

**Condizioni speciali per le personalizzazioni**

1. L'Azienda si riserva il diritto di non eseguire la personalizzazione qualora tecnicamente non eseguibile.
2. Ordini personalizzati e/o esecuzioni particolari non possono essere annullati.
3. I prodotti personalizzati non possono essere resi per sostituzione.
4. Le richieste di imballaggi specifici saranno a carico del Cliente.

**Commercializzazione**

1. La merce è destinata alla commercializzazione nel Paese in cui ha sede il Cliente. Qualora la merce sia commercializzata in un Paese differente, sarà onere del Cliente verificare le normative applicabili in tale Paese incluse le normative doganali e di importazione, nonché il rischio di contestazioni da parte di terzi a qualunque titolo, restando inteso che Sambonet Paderno Industrie S.p.A. sarà manlevata e tenuta indenne dal Cliente per quanto causato dalla vendita della merce in tale diverso Paese.
2. Sambonet Paderno Industrie S.p.A. non fornisce alcuna garanzia in ordine a possibili contestazioni di violazione di diritti di proprietà industriale ed intellettuale di terzi, in particolare nell'ipotesi di rivendita della merce a mezzo Internet.
3. È vietato pubblicare prezzi inferiori ai listini vigenti in siti web senza autenticazione.

**Riserva di proprietà e condizioni di pagamento**

1. Eventuali reclami non potranno in alcun caso avere come effetto il differimento o la sospensione dei pagamenti.
2. Il Cliente in situazioni di ritardo di pagamento sarà peraltro debitore di diritto, nei confronti di Sambonet Paderno Industrie S.p.A. di un indennizzo forfettario per spese di sollecito pari a € 40,00. Qualora le spese di sollecito siano superiori al suddetto importo, Sambonet Paderno Industrie S.p.A. avrà il diritto di richiedere un ulteriore indennizzo.
3. In caso di mancato pagamento di tutta o parte della fattura, o di aggravio della situazione finanziaria del Cliente, Sambonet Paderno Industrie S.p.A. avrà anche la facoltà di:
  - a) sospendere o annullare gli ordini e le consegne in corso;
  - b) esigere un pagamento anticipato per gli ulteriori ordini e/o garanzie di pagamento.

**Consegna**

1. Le scadenze di consegna sono indicate il più esattamente possibile, ma dipendono dalle condizioni di approvvigionamento e trasporto di Sambonet Paderno Industrie S.p.A., la quale si impegna a porre la massima diligenza ai fini del rispetto delle consegne salvo cause di forza maggiore.
2. Il superamento dei tempi di consegna previsti, non potrà vincolare Sambonet Paderno Industrie S.p.A. al versamento di penali, risarcimenti per danni e interessi.
3. Qualsiasi modifica di ordine darà luogo a una conseguente modifica della data di consegna.
4. Sono considerate come cause di forza maggiore, che svincolano Sambonet Paderno Industrie S.p.A. dall'obbligo di consegna: guerra, rivolta, incendio, scioperi, impossibilità di approvvigionamento, incidenti particolarmente rilevanti all'attrezzatura, la rottura di macchine, l'interruzione o il ritardo nel trasporto.
5. Sambonet Paderno Industrie S.p.A. terrà il Cliente tempestivamente informato di qualsiasi ritardo. In ogni caso, la consegna entro i termini potrà essere effettuata soltanto se il Cliente avrà puntualmente ottemperato a tutti i suoi obblighi nei confronti di Sambonet Paderno Industrie S.p.A., qualsiasi sia la causa.
6. Viene peraltro convenuto tra le parti che se il Cliente non prenderà possesso dei prodotti ordinati alle condizioni stabilite, Sambonet Paderno Industrie S.p.A. fatturerà al Cliente:
  - a) qualsiasi ulteriore spesa di trasporto e/o giacenza;
  - b) spese di custodia equivalenti al 5% dell'importo dell'ordine, tasse escluse, per ogni mese di ritardo.

**Avvertenze importanti**

1. La percezione del colore può risultare soggettiva in funzione di geometria, dimensioni, finiture e illuminazione dell'ambiente. I prodotti sottoposti a lavorazione PVD potrebbero essere soggetti a piccole variazioni cromatiche o discontinuità tra diversi modelli, tra diverse referenze o tra partite diverse dello stesso prodotto. Tali variazioni sono comprese entro limiti di tolleranza prestabiliti e strettamente monitorati.
2. In fase di stampa sono possibili errori e/o omissioni. Sambonet Paderno Industrie S.p.A. si riserva il diritto di rettifica di eventuali errori di stampa o calcolo.
3. Le immagini, le caratteristiche e le misure espresse sono indicative e soggette a variazioni senza preavviso.
4. Le sagome delle posate illustrate di questa pubblicazione sono puramente indicative e non si riferiscono alle sagome reali.

## DEU

### Allgemeine Verkaufsbedingungen

1. Bestellungen sind erst nach Bestätigung durch Sambonet Paderno Industrie S.p.A. gültig.
2. **Mindestwarenbestellwert € 100,00 netto.**
3. Standardverpackung kostenlos.
4. Änderungen dieser Bedingungen bedürfen der Schriftform.

### Eigentumsrecht und Zahlungsbedingungen

1. Die gelieferte Ware bleibt bis zur vollständigen Bezahlung der Rechnung durch den Kunden Eigentum der Sambonet Paderno Industrie S.p.A.
2. Die Bezahlung der Rechnung muss innerhalb der zwischen den Parteien zuvor vereinbarten Zahlungsfrist erfolgen. Nach Ablauf dieser Frist werden Verzugszinsen in der in Art. 5 der [italienischen gesetzesvertretenden Verordnung] D. Lgs. 231/2002 (in der durch D. Lgs. 192/2012 geänderten Fassung) vorgesehenen Höhe zuzüglich 8 % fällig.

### Angebote/Bestellungen

1. Angebote von Sambonet Paderno Industrie S.p.A. sind freibleibend.
2. Mit der schriftlichen Annahme des Angebots oder der Auftragsbestätigung (mit allen enthaltenen Bedingungen) wird eine in jeder Hinsicht wirksame Bestellung aufgegeben, die mit der Ausführung eines Vertrags gemäß den allgemeinen Verkaufsbedingungen verbunden ist.

### Rückgaben/Reklamationen

1. Die Ware ist bei Erhalt zu kontrollieren.
2. Sollten Pakete defekt/beschädigt sein, so ist das Transportdokument unter Vorbehalt und mit Angabe der Gründe (z. B. ein Foto der Ware, auf der die Kennzeichnung der Ware und die Spedition erkennbar sind, und eine Beschreibung des Defekts) zu unterschreiben. Reklamationen werden innerhalb von 15 Tagen nach Rechnungsdatum als letzte nicht verhandelbare Frist unter folgenden Bedingungen angenommen:
  - a) Die Reklamation/der Antrag auf Rücknahme der Ware erfolgt über das angeleitete Verfahren im Benutzerbereich der Website [www.agenti.sambonet.it](http://www.agenti.sambonet.it);
  - b) Die Lieferung erfolgt frei unserem Werk;
  - c) Liegt die Verantwortung für die Rückgabe beim Kunden, Sambonet Paderno Industrie S.p.A. stellt 15% des Nettopreises, jedoch mindestens € 25,00 als Bearbeitungskosten in Rechnung;
  - d) Liegt die Verantwortung nachgewiesenermaßen bei Sambonet Paderno Industrie S.p.A., wird die Ware ersetzt und dem Kunden frei Haus zugestellt;
  - e) Im Falle von Produkten, die zur Reparatur zurückgegeben werden und keiner Gewährleistung unterliegen, gehen die Kosten für Zu- und Rücksendung zu Lasten des Kunden;
  - f) Nicht angenommen werden Rücksendungen von Sonderartikeln (nicht im Katalog), kundenindividuellen Artikeln und Artikeln, deren Produktion eingestellt wurde.

### Stornierung der Bestellung

1. Bestellungen von Produkten, die nicht im Katalog enthalten oder die kundenindividuell gefertigt sind, oder Bestellungen von Sonderartikeln können NICHT storniert werden.
2. Bei Produkten aus dem Katalog ist eine Stornierung nur möglich, wenn die Bestellung noch nicht bestätigt wurde.

### Lieferbedingungen – Gruppe A

*Österreich, Deutschland, Holland, Belgien, Luxemburg, Frankreich, Großbritannien:*

1. Die Lieferung zum Kunden erfolgt frei Haus, wobei:
  - a) bei einem Warenbestellwert zwischen € 100,00 und € 350,00 netto eine Pauschale von € 15,00 in Rechnung gestellt wird;
  - b) bei einem Warenbestellwert von über € 350,00 netto keine Versandkosten in Rechnung gestellt werden.
2. Die vorstehenden Bedingungen gelten nur für den Versand mit dem Vertragsspediteur von Sambonet Paderno Industrie S.p.A.

### Lieferbedingungen – Gruppe B

*Spanien, Portugal, Polen, Tschechische Republik, Slowakei, Ungarn, Rumänien, Slowenien, Kroatien, Bulgarien, Dänemark, Norwegen:*

1. Die Lieferung zum Kunden erfolgt frei Haus, wobei:
  - a) bei einem Warenbestellwert zwischen € 100,00 und € 600,00 netto eine Pauschale von € 30,00 in Rechnung gestellt wird;
  - b) bei einem Warenbestellwert von über € 600,00 netto keine Versandkosten in Rechnung gestellt werden.
2. Die vorstehenden Bedingungen gelten nur für den Versand mit dem Vertragsspediteur von Sambonet Paderno Industrie S.p.A.

### Lieferbedingungen – Gruppe C

*Griechenland, Irland, Lettland, Litauen, Estland, Schweden, Finnland:*

1. Die Lieferung zum Kunden erfolgt frei Haus, wobei:
  - a) bei einem Warenbestellwert zwischen € 100,00 und € 1.000,00 netto eine Pauschale von € 50,00 in Rechnung gestellt wird;
  - b) bei einem Warenbestellwert von über € 1.000,00 netto keine Versandkosten in Rechnung gestellt werden.
2. Die vorstehenden Bedingungen gelten nur für den Versand mit dem Vertragsspediteur von Sambonet Paderno Industrie S.p.A.

### Lieferbedingungen – Gruppe D

*EU- und Nicht-EU-Länder, die in den vorherigen Absätzen nicht aufgeführt sind:*

1. Die Lieferung erfolgt frei Werk.

### Kundenindividuelle Anfertigungen (die angegebenen Kosten verstehen sich als Nettobeträge)

1. Auf Wunsch des Kunden stellt Sambonet Paderno Industrie S.p.A. kundenindividuelle und Sonderanfertigungen her. Es gelten die folgenden Bedingungen:
  - a) Es wird eine **Anzahlung in Höhe von 30 %** des Bestellwertes geleistet;
  - b) Die Lieferung wird nach der Freigabe der endgültigen Gestaltung und/oder des Musters vereinbart;
  - c) Sambonet Paderno Industrie S.p.A. behält sich in Bezug auf den Versand der bestellten Mengen für jeden einzelnen Artikel einen **Toleranzwert** von +/- 10 % mit Aufrundung auf die nächsthöhere Einheit vor;
  - d) Sambonet Paderno Industrie S.p.A. legt dem Kunden ein Beschreibungsblatt mit allen erforderlichen Parametern (Zeichnung, Platzierung, Abmessungen usw.) vor. Die Lieferung erfolgt erst, nachdem der Kunde dieses zum Zeichen der Annahme unterschrieben und zurückgesendet hat.
2. Wellenschliff Obstmesser, wenn nicht serienmäßig vorgesehen, Aufpreis von € 0,65 pro Stück.
3. Gravur mit Pantograf/Laser
  - a) Einrichtungskosten: € 70,00;
  - b) Gravurkosten: Besteck € 0,50 pro Stück – Geschirr, sofern Gravur möglich, € 1,00 pro Stück;
  - c) Mindestmengen: Besteck 100 Stück je Artikel – Geschirr 10 Stück je Artikel.
4. Stanzungen:
  - a) Punzen: erste Punze € 300,00 – jede weitere € 150,00;
  - b) Stanzkosten: Besteck € 0,50 pro Stück – Geschirr: bitte Kostenvorschlag anfordern;
  - c) Mindestmengen:
    - Erstbestellung: Besteck 1.000 Stück je Artikel – Messer mit Hohlheftgriff 800 Stück je Artikel;
    - Folgebestellungen: Besteck 100 Stück je Artikel – Messer mit Hohlheftgriff 800 Stück je Artikel.

### Personalisierungen Sambonet Tailor Made (die angegebenen Beträge sind Nettobeträge)

1. Arten Standardgravuren Tailor-Made:
  - a) Auf dem vorderen Ende des Besteckgriffs: eines der Standardlogos, oder das Monogramm (zwei Buchstaben) mit Standardschriftarten;
  - b) Auf dem hinteren Ende des Besteckgriffs: Datum im Standardformat, mit einer Standardschriftart;
2. Kosten der Gravur Tailor-Made:
  - a) € 19,90 für Gravuren auf dem Ende des Besteckgriffs / Vorderseite;
  - b) € 19,90 für Gravuren auf dem Ende des Besteckgriffs / Hinterseite;
  - c) € 39,80 für Gravuren auf dem Ende des Besteckgriffs / Vorder- und Hinterseite.
3. Mindestbestellung für lose Artikel Tailor-Made:
  - a) 6 St. für die Bezugsprofile in Alpaca, in Vielfachstückelungen von 6 St.;
  - b) 12 St. für alle anderen Bezugsprofile, in Vielfachstückelungen von 12 St.;
4. Anwendung der Preise für die Gravur Tailor-Made auf die einzelne Bestellung:
  - a) Nur einmalige Zahlung für jede Art von Gravur – wie in Punkt 2 angeführt;
  - b) Nur einmalige Zahlung unabhängig von der Zahl der Artikel – bei Überschreitung der Mindestbestellung wie in Punkt 3 angeführt;
  - c) Nur einmalige Zahlung unabhängig von der Stückzahl bis zu 150 St.
  - d) bei mehr als 150 St. und Vielfachen von 150 St. werden die Kosten für die Gravur erneut veranschlagt.

### Sonderkonditionen für Personalisierungen

1. Die Firma behält sich das Recht vor die Personalisierung nicht auszuführen, wenn diese technisch nicht durchführbar ist.
2. Bestellungen von kundenindividuellen und/oder nicht standardmäßigen Sonderanfertigungen können nicht storniert werden.
3. Kundenindividuell gefertigte Artikel können nicht umgetauscht werden.
4. Besondere Verpackungsanfragen gehen zu Lasten des Kunden.

### Vertrieb

1. Die Ware ist für die Vermarktung in dem Land, in dem der Kunde ansässig ist, bestimmt. Wenn die Ware in einem anderen Land vermarktet wird, liegt es in der Verantwortung des Kunden, die in diesem Land geltenden Vorschriften einschließlich Zoll- und Einfuhrbestimmungen sowie das Risiko von Streitigkeiten durch Dritte aus irgendeinem Grund zu überprüfen. Es versteht sich, dass Sambonet Paderno Industrie S.p.A. für jede mögliche Streitigkeit, die durch den Verkauf der Ware in diesem anderen Land entstehen kann, schadlos gehalten wird.
2. Sambonet Paderno Industrie S.p.A. übernimmt keine Garantie für eventuelle Ansprüche wegen Verletzung von gewerblichen Schutzrechten und Rechten des geistigen Eigentums Dritter, insbesondere im Falle des Weiterverkaufs der Ware über Internet.
3. Die Veröffentlichung von Preisen, die unter denen der geltenden Preislisten liegen, ist auf Webseiten ohne Authentisierung verboten.

### Eigentumsvorbehalt und Zahlungskonditionen

1. Eventuelle Beanstandungen können in keinem Fall den Aufschub oder die Unterbrechung der Zahlungen zur Folge haben.
2. Bei Zahlungsverzögerungen ist der Kunde im Übrigen gegenüber Sambonet Paderno Industrie S.p.A. rechtmäßiger Schuldner einer pauschalen Erstattung für Mahnaufwendungen, die sich auf € 40,00 beläuft. Wenn die Mahnaufwendungen den oben genannten Betrag überschreiten, hat Sambonet Paderno Industrie S.p.A. das Recht eine weitere Erstattung einzufordern.
3. Im Falle der Nichtzahlung des vollständigen oder teilweisen Rechnungsbetrags oder einer Verschlechterung der finanziellen Lage des Kunden hat Sambonet Paderno Industrie S.p.A. auch die Befugnis:
  - a) laufende Bestellungen und Lieferungen zu unterbrechen oder zu annullieren;
  - b) eine Vorauszahlung für weitere Bestellungen und/oder Zahlungsverpflichtungen zu verlangen.

### Lieferung

1. Die Liefertermine sind so genau wie möglich angegeben, hängen aber von den Materialbeschaffungs- und Transportbedingungen ab. Sambonet Paderno Industrie S.p.A. bemüht sich aufs Äußerste die Auslieferungstermine einzuhalten. Ausgenommen davon sind Fälle von höherer Gewalt.
2. Die Überschreitung der vorgesehenen Lieferzeiten verpflichtet Sambonet Paderno Industrie S.p.A. nicht zur Zahlung von Straf-, Schadensersatz- und Zinszahlungen.
3. Jede Änderung einer Bestellung hat eine Änderung des Liefertermins zur Folge.
4. Als Fälle von höherer Gewalt und somit als Bedingungen, die Sambonet Paderno Industrie S.p.A. von der Lieferpflicht entbinden, gelten: Krieg, Aufruhr, Brand, Streiks, Unmöglichkeit der Materialbeschaffung, erhebliche Unfälle an den Geräten, der Bruch einer Maschine, die Unterbrechung oder Verspätung des Transports.
5. Sambonet Paderno Industrie S.p.A. informiert den Kunden rechtzeitig über jede Art von Verspätung. In jedem Fall kann die vereinbarte Lieferung nur erfolgen wenn der Kunde alle seine Verpflichtungen gegenüber Sambonet Paderno Industrie S.p.A. pünktlich erfüllt hat und zwar aus welchem Grund auch immer.
6. Darüberhinaus wird zwischen den Parteien vereinbart, dass, wenn der Kunde die bestellten Produkte nicht zu den festgelegten Konditionen entgegen nimmt, Sambonet Paderno Industrie S.p.A. dem Kunden:
  - a) jede weitere Ausgabe für Transport und/oder Einlagerung;
  - b) Aufbewahrungskosten in Höhe von 5% des Betrags der Bestellung, ausschließlich Steuer, für jeden Monat Verspätung in Rechnung stellt.

### Wichtige Hinweise

1. Die Wahrnehmung von Farbe kann subjektiv sein und abhängig von der Geometrie, der Dimension, der Ausführung und der Beleuchtung eines Raums. Produkte, die dem PVD-Verfahren unterzogen werden, können kleine Farbvariationen oder Unterschiede bei verschiedenen Modellen, verschiedenen Referenzen oder Produktionschargen des gleichen Produkts aufweisen. Iese Farbabweichungen befinden sich im Rahmen eines im Voraus festgelegten Toleranzbereiches und werden streng überwacht.
2. Beim Druck kann es zu Fehlern und/oder Auslassungen kommen. Sambonet Paderno Industrie S.p.A. behält sich die Korrektur von Druck- oder Rechenfehlern vor.
3. Fotos und Abmessungen sind nur als Information zu verstehen. Wir behalten uns das Recht vor, die angegebenen Spezifikationen jederzeit zu ändern.
4. Das Profil der Bestecke ist nur als Informationsskizze zu verstehen. Es stellt nicht dar die wirklichen Profile.



# FRA

## Termes et conditions générales de vente

1. Toute commande est soumise à l'acceptation de Sambonet Paderno Industrie S.p.A.
2. Le montant minimum de commande est de € 100,00 net HT.
3. Emballage standard gratuit.
4. Toute modification de ces conditions doit se faire par écrit.

## Droit de propriété et conditions de paiement

1. Les marchandises fournies restent la propriété de Sambonet Paderno Industrie S.p.A. jusqu'au paiement intégral de la facture par le client.
2. La facture doit être réglée dans le délai préalablement convenu entre les parties. Tout retard de paiement entraînera l'application d'intérêts calculés au taux fixé par l'article 5 du décret législatif italien 231/2002 tel que modifié par le décret législatif italien 192/2012, majoré de 8%.

## Offres/ Commandes

1. Les offres de Sambonet Paderno Industrie S.p.A. sont libres et n'engagent pas à passer une commande.
2. L'acceptation d'une offre par écrit, ou la confirmation de la commande (et les manières qui sont contenu), sera réputée une véritable commande, qui entraîne l'exécution d'un contrat conforme aux termes et aux conditions générales de vente.

## Retours/Réclamations

1. Les marchandises doivent être contrôlées à la réception.
2. En cas de colis défectueux / endommagés, le document de transport devra être signé sous réserve, en spécifiant les raisons (la photo du colis avec l'étiquette logistique et le ruban du transporteur bien en évidence, accompagnée de la description du défaut, vaut réserve).
3. Les réclamations doivent être soumises dans un délai maximum non négociable de 15 jours à compter de la date de la facture, aux conditions suivantes:
  - a) la réclamation / la demande de retour de marchandises doit être soumise en suivant la procédure assistée disponible à l'adresse [www.agenti.sambonet.it](http://www.agenti.sambonet.it) dans l'espace utilisateur;
  - b) Tous les retours de marchandises sont départ notre usine;
  - c) en cas de responsabilité du client, Sambonet Paderno Industrie S.p.A. facturera 15% du prix net, avec un montant minimum de € 25,00, pour les frais de gestion;
  - d) en cas de responsabilité avérée de Sambonet Paderno Industrie S.p.A., les marchandises seront remplacées et retournées franco domicile client;
  - e) pour les produits retournés pour réparation hors garantie, les frais de transport aller-retour sont à la charge du client;
  - f) les retours d'articles spéciaux (hors catalogue), personnalisés ou hors production ne sont pas acceptés.

## Annulation des commandes

1. Les commandes de produits hors catalogue, personnalisés ou spéciaux ne peuvent pas être annulées.
2. Les commandes de produits sur catalogue ne peuvent être annulées que si la commande n'a pas encore été confirmée.

## Conditions de livraison – Groupe A

*Autriche, Allemagne, Pays-Bas, Belgique, Luxembourg, France, Royaume-Uni:*

1. Les envois de marchandises sont franco domicile client:
  - a) avec € 15,00 à la charge du client pour tout montant net HT de commande de € 100,00 à € 350,00;
  - b) sans aucune charge pour tout montant net HT de commande supérieur à € 350,00.
2. Les conditions susmentionnées ne sont valables que pour les envois effectués par le transporteur conventionné avec Sambonet Paderno Industrie S.p.A.

## Conditions de livraison – Groupe B

*Espagne, Portugal, Pologne, République tchèque, Slovaquie, Hongrie, Roumanie, Slovaquie, Croatie, Bulgarie, Danemark, Norvège:*

1. Les envois de marchandises sont franco domicile client:
  - a) avec € 30,00 à la charge du client pour tout montant net HT de commande de € 100,00 à € 600,00;
  - b) sans aucune charge pour tout montant net HT de commande supérieur à € 600,00.
2. Les conditions susmentionnées ne sont valables que pour les envois effectués par le transporteur conventionné avec Sambonet Paderno Industrie S.p.A.

## Conditions de livraison – Groupe C

*Grèce, Irlande, Lettonie, Lituanie, Estonie, Suède, Finlande:*

1. Les envois de marchandises sont franco domicile client:
  - a) avec € 50,00 à la charge du client pour tout montant net HT de commande de € 100,00 à € 1.000,00;
  - b) sans aucune charge pour tout montant net HT de commande supérieur à € 1.000,00.
2. Les conditions susmentionnées ne sont valables que pour les envois effectués par le transporteur conventionné avec Sambonet Paderno Industrie S.p.A.

## Conditions de livraison – Groupe D

*Pays de l'UE et extra-UE non spécifiés dans les paragraphes précédents:*

1. Tous les envois de marchandises sont départ usine.

## Produits personnalisés (Les prix indiqués sont nets)

1. Sambonet Paderno Industrie S.p.A. est en mesure de réaliser des produits personnalisés à la demande du client aux conditions suivantes:
  - a) paiement d'un acompte de 30% sur le montant de la commande;
  - b) livraison à convenir après l'approbation du dessin exécutif et/ou de l'échantillon;
  - c) Sambonet Paderno Industrie S.p.A. se réserve le droit d'appliquer à chaque référence une tolérance de livraison sur les quantités commandées de +/- 10% arrondie à l'unité supérieure;
  - d) Sambonet Paderno Industrie S.p.A. enverra au client une fiche avec toutes les données techniques nécessaires (dessin, position, dimensions, etc.) et n'exécutera la commande qu'à la réception de la fiche signée pour autorisation.
2. Couteaux à dessert exécutés avec lame dentelée (si cette lame n'est pas la lame standard): € 0,65 par pièce.
3. Gravure pantographe/laser:
  - a) frais de commande: € 70,00;
  - b) frais de gravure: couverts € 0,50 par pièce - plats et articles de table, si gravure faisable, € 1,00 par pièce;
  - c) quantité minimum de commande: couverts 100 pièces pour chaque référence - plats et articles de table 10 pièces pour chaque référence.
4. Poinçonnage:
  - a) frais de poinçon: € 300,00 pour le premier poinçon - € 150,00 pour chaque poinçon supplémentaire;
  - b) frais de poinçonnage: couverts € 0,50 par pièce - plats et articles de table: devis sur demande;
  - c) quantité minimum de commande:
    - première commande: couverts 1.000 pièces par référence - couteaux poignée creuse 800 pièces par référence;
    - commandes suivantes: couverts 100 pièces par référence - couteaux poignée creuse 800 pièces par référence.

## Personnalisations Sambonet Tailor Made (Les prix indiqués sont nets)

1. Types de gravures Tailor Made standard :
  - a) Au recto du manche : un des logos standard ou un monogramme (deux lettres) en utilisant l'une des polices standard ;
  - b) Au verso du manche : la date au format standard en utilisant l'une des polices standard ;
2. Coût de la gravure Tailor Made :
  - a) 19,90 € pour les gravures au recto du manche ;
  - b) 19,90 € pour les gravures au verso du manche ;
  - c) 39,80 € pour les gravures au recto et au verso du manche.
3. Minimum d'achat pour des articles en vrac Tailor Made :
  - a) 6 pièces pour les références en maillechort, par multiple de 6 pièces ;
  - b) 12 pièces pour toutes les autres références, par multiple de 12 pièces ;
4. Application du coût de la gravure Tailor Made sur chaque commande :
  - a) Un coût unique pour chaque type de gravure – indiqués au point 2 ;
  - b) Un coût unique quel que soit le nombre de références – à condition qu'il soit supérieur au minimum d'achat indiqué au point 3 ;
  - c) Un coût unique quel que soit le nombre de pièces jusqu'à 150 pièces.
  - d) Au-delà de 150 pièces et par multiple de 150 pièces, le coût de la gravure sera à nouveau appliqué.

## Conditions spéciales pour les personnalisations

1. L'entreprise se réserve le droit de ne pas procéder à la personnalisation pour des raisons de faisabilité technique.
2. Les commandes de produits personnalisés e/o spéciaux ne peuvent pas être annulées.
3. Les produits personnalisés ne peuvent pas être retournés pour remplacement.
4. Toute demande d'emballage spécifique est à la charge du Client.

## Commercialisation

1. Les produits sont destinés à la commercialisation dans le Pays où le client est basé. Si les produits sont vendus dans un autre Pays, il est de la responsabilité du client de vérifier les réglementations applicables dans ce Pays, y compris les réglementations douanières et d'importation, ainsi que le risque de litiges par des tiers pour quelque motif que ce soit, étant entendu que Sambonet Paderno Industrie S.p.A. sera déchargé de tout litige qui pourrait survenir dans ce Pays différent.
2. Sambonet Paderno Industrie S.p.A. ne fournit aucune garantie quant à d'éventuelles actions pour violation des droits de propriété industrielle et intellectuelle par des tiers, en particulier en cas de revente du produit sur Internet.
3. Il est interdit de publier des prix inférieurs aux tarifs en vigueur sur des sites Web sans authentification.

## Réserve de propriété et conditions de paiement

1. Toute réclamation du Client ne peut en aucun cas avoir pour effet de différer ou de suspendre le paiement.
2. En cas de retard de paiement, le Client est redevable de plein droit, envers Sambonet Paderno Industrie S.p.A., d'une indemnité forfaitaire de 40,00 € pour frais de recouvrement. Si les frais de recouvrement sont supérieurs à ce montant, Sambonet Paderno Industrie S.p.A. est en droit de réclamer une indemnisation complémentaire.
3. En cas de non-paiement de tout ou partie de la facture, ou en cas de dégradation de la situation financière du Client, Sambonet Paderno Industrie S.p.A. a également le droit de :
  - a) suspendre ou annuler toute commande et livraison en cours ;
  - b) exiger un acompte pour toute nouvelle commande et/ou des garanties de paiement.

## Livraison

1. Les délais de livraison sont indiqués aussi exactement que possible, mais sont fonction des possibilités d'approvisionnement et de transport de Sambonet Paderno Industrie S.p.A., qui s'engage à respecter les délais de livraison avec la plus grande rigueur sauf cas de force majeure.
2. Les dépassements de délai de livraison ne peuvent donner lieu au paiement de pénalités et de dommages-intérêts par Sambonet Paderno Industrie S.p.A.
3. Toute modification de la commande entraînera une modification de la date de livraison.
4. Sont considérés comme cas de force majeure déchargeant Sambonet Paderno Industrie S.p.A. de son obligation de livrer : la guerre, l'émeute, l'incendie, les grèves, l'impossibilité d'être approvisionné, les accidents graves de matériel, les pannes de machines, l'interruption ou le retard dans les transports.
5. Sambonet Paderno Industrie S.p.A. s'engage à informer le Client sans délai de tout retard. En toute hypothèse, la livraison dans les délais ne peut intervenir que si le Client est à jour de ses obligations envers Sambonet Paderno Industrie S.p.A., quelle qu'en soit la cause.
6. Les parties conviennent également que si le Client ne prend pas possession des produits commandés selon les conditions fixées, Sambonet Paderno Industrie S.p.A. lui facturera :
  - a) les frais supplémentaires de transport et/ou de stockage ;
  - b) les frais de garde équivalents à 5 % du montant de la commande, hors taxes, pour chaque mois de retard.

## Avertissements importants

1. La perception de la couleur peut être subjective en fonction de la géométrie, des dimensions, des finitions et de l'éclairage du local. Les produits soumis à un traitement PVD pourraient subir de petites variations chromatiques ou des discontinuités parmi des modèles, des références ou des lots différents du même produit. Ces variations sont comprises dans les limites de tolérance préétablies et strictement surveillées.
2. Des fautes et/ou des omissions peuvent survenir lors de l'impression. Sambonet Paderno Industrie S.p.A. se réserve le droit de corriger toute faute d'impression ou de calcul.
3. Les photos et dimensions indiquées sont indicatives. Sambonet Paderno Industrie S.p.A. se réserve le droit de modifier à tout moment les spécifications techniques.
4. Les silhouettes des couverts de ce tarif sont uniquement indicatives et elles ne se réfèrent pas à la silhouette réelle des couverts.

## ESP

### Condiciones generales y de venta

1. Los pedidos deben ser aprobados por Sambonet Paderno Industrie S.p.A.
2. Pedido mínimo de € 100,00 en factura.
3. Embalaje estándar incluido.
4. Cualquier variación de las presentes condiciones debe realizarse por escrito.

### Derecho de propiedad y condiciones de pago

1. La mercancía queda de propiedad de Sambonet Paderno Industrie S.p.A. hasta que el cliente realice el pago total de la factura.
2. El plazo de pago de la factura debe realizarse dentro de los términos establecidos previamente por las partes. Al caducar dicho plazo, deberán considerarse los intereses de demora según lo dispuesto por el art. 5 D.LGS 231/2002 y siguientes modificaciones, como previsto en el D.LGS. 192/2012, con aumento del 8%.

### Ofertas/Pedidos

1. Las ofertas de Sambonet Paderno Industrie S.p.A. son libres y no vinculantes al pedido.
2. Aceptando por escrito la oferta, o de la confirmación del pedido (con la modalidad en ella incluidas) se produce a todos los efectos un pedido que implica un contrato conforme a las condiciones generales y de venta.

### Restituciones/Reclamaciones

1. La mercancía debe controlarse en el momento de la entrega.
2. En caso de embalajes defectuosos/deteriorados, el documento de transporte se deberá firmar bajo reserva especificando las razones (como reserva se debe presentar la foto del embalaje y su código de barra, la cinta del servicio de transporte y la descripción de la avería).
3. Las reclamaciones se aceptarán dentro de **15 días** a partir de la fecha de emisión de la factura, plazo no negociable, bajo las condiciones que se citan a continuación:
  - a) La reclamación/solicitud de restitución de mercancía debe realizarse a través del procedimiento guiado en la página web: [www.agenti.sambonet.it](http://www.agenti.sambonet.it) en el área de usuarios;
  - b) La mercancía se entrega franco nuestra fábrica;
  - c) En caso de que el cliente sea responsable, Sambonet Paderno Industrie S.p.A. le cargará el 15% del precio neto, con un mínimo de € 25,00 de coste de gestión;
  - d) en caso de responsabilidad comprobada de Sambonet Paderno Industrie S.p.A., la mercancía será reemplazada y entregada al cliente con porte pagado;
  - e) los gastos de transporte para la reparación de productos sin garantía, corren a cargo del cliente;
  - f) para los artículos especiales (no incluidos en el catálogo), personalizados o fuera de producción no será posible restituir la mercancía.

### Cancelación del pedido

- a) para los productos no incluidos en el catálogo, personalizados o especiales NO es posible cancelar el pedido.
- b) para los productos incluidos en el catálogo, es posible cancelar el pedido sólo en caso de que aún no haya sido confirmado.

### Condiciones de entrega – Grupo A

*Austria, Alemania, Holanda, Bélgica, Luxemburgo, Francia, Reino Unido:*

1. La mercancía se remite a porte pagado:
  - a) cargando € 15,00 para pedidos de entre € 100,00 y € 350,00 netos;
  - b) sin cargo alguno si el pedido neto sobrepasa los € 350,00.
2. Las condiciones mencionadas arriba deben considerarse válidas sólo para los servicios de transporte elegidos por Sambonet Paderno Industrie S.p.A.

### Condiciones de entrega – Grupo B

*España, Portugal, Polonia, República Checa, Eslovaquia, Hungría, Rumania, Eslovenia, Croacia, Bulgaria, Dinamarca, Noruega:*

1. La mercancía se remite a porte pagado:
  - a) cargando € 30,00 para pedidos de entre € 100,00 y € 600,00 netos;
  - b) sin cargo alguno si el pedido neto sobrepasa los € 600,00.
2. Las condiciones mencionadas arriba deben considerarse válidas sólo para los servicios de transporte elegidos por Sambonet Paderno Industrie S.p.A.

### Condiciones de entrega – Grupo C

*Grecia, Irlanda, Letonia, Lituania, Estonia, Suecia, Finlandia:*

1. La mercancía se remite a porte pagado:
  - a) cargando € 50,00 para pedidos de entre € 100,00 y € 1.000,00 netos;
  - b) sin cargo alguno si el pedido neto sobrepasa los € 1.000,00.
2. Las condiciones mencionadas arriba deben considerarse válidas sólo para los servicios de transporte elegidos por Sambonet Paderno Industrie S.p.A.

### Condiciones de entrega – Grupo D

*Países de la UE y países extra-UE no especificados en los párrafos anteriores:*

1. La mercancía se entrega franco fábrica.

### Personalizaciones (Los precios indicados deben considerarse netos)

1. Bajo solicitud del cliente, Sambonet Paderno Industrie S.p.A. realiza personalizaciones y acabados particulares según las siguientes condiciones:
  - a) **pago de un anticipo del 30%** del valor del pedido;
  - b) La entrega será establecida tras aprobar el diseño ejecutivo y/o la muestra;
  - c) Sambonet Paderno Industrie S.p.A. se reserva el derecho de aplicar, en cada artículo, una **tolerancia del +/- 10%**, redondeando por exceso, para el envío de las cantidades solicitadas;
  - d) Sambonet Paderno Industrie S.p.A. enviará al cliente una ficha con toda la información necesaria (diseño, posición, medidas, ecc). La entrega se efectuará sólo después de haber recibido la ficha firmada por el cliente.
2. Endentado de hojas cuchillos postre: si no previsto de serie, con cargo de € 0,65 / pieza.
3. Grabado por Pantógrafo/Láser:
  - a) coste instalación: € 70,00;
  - b) coste grabado: cubiertos € 0,50 / pieza – vajilla, grabado (si es posible) € 1,00 / pieza;
  - c) cantidades mínimas. Cubiertos: 100 piezas por modelo – vajilla: 10 piezas por modelo.
4. Punzonado:
  - a) coste punzones: € 300,00 para el primer punzón – € 150,00 para los siguientes (cada uno);
  - b) coste punzonado: cubiertos € 0,50 / pieza – vajilla: solicitando un presupuesto;
  - c) pedidos mínimos:
    - nuevas instalaciones. Cubiertos: 1.000 piezas por modelo – cuchillos de mango hueco: 800 piezas por modelo;
    - pedidos adicionales. Cubiertos: 100 piezas por modelo – cuchillos de mango hueco: 800 piezas por modelo.

### Personalizaciones Sambonet Tailor Made (Los costes indicados son netos)

1. Tipos de grabados Tailor Made estándar:
  - a) En el terminal frontal: uno de los logotipos estándar, o el monograma (dos letras) usando uno de los caracteres estándar;
  - b) En el terminal trasero: la fecha en formato estándar, utilizando uno de los caracteres estándar;
2. Coste de grabado Tailor Made:
  - a) € 19,90 para grabados en el terminal frontal;
  - b) € 19,90 para grabados en el terminal trasero;
  - c) € 39,80 para grabados en el terminal delantero y en el terminal trasero.
3. Pedido mínimo de compra para artículos sueltos Tailor Made:
  - a) 6 pzas para las referencias hechas en alpaca, con múltiples de 6 pzas;
  - b) 12 pzas para todas las otras referencias, con múltiples de 12 pzas;
4. Aplicación del coste de grabado Tailor Made en un único pedido de compra:
  - a) Un solo coste para cada tipo de grabado - indicados en el punto 2;
  - b) Un solo coste independientemente del número de referencias - si superiores al mínimo de compra indicado en el punto 3;
  - c) Un solo coste independientemente del número de pzas hasta 150 pzas.
  - d) Con más de 150 pzas y múltiples de 150 pzas se aplicará otra vez el coste de grabado.

### Condiciones especiales para las personalizaciones

1. La Empresa se reserva el derecho de no llevar a cabo la personalización si no fuera técnicamente realizable.
2. Pedidos personalizados y/o acabados particulares no se pueden cancelar.
3. No se pueden devolver, para su reemplazo, los productos personalizados.
4. Las solicitudes de embalajes específicos correrán a cargo del Cliente.

### Comercialización

1. Los productos están destinados a la comercialización en el País donde se encuentra el cliente. Si los productos se comercializan en un País diferente, será responsabilidad del cliente verificar las regulaciones aplicables en ese País, incluidas las regulaciones de aduanas e importación, así como el riesgo de disputas por parte de terceros por cualquier motivo, entendiéndose que Sambonet Paderno Industrie SpA estará libre de cualquier disputa que pueda surgir en este País diferente.
2. Sambonet Paderno Industrie S.p.A. no ofrece ninguna garantía con respecto a posibles reclamos de violación de derechos de propiedad industrial e intelectual de terceros, en particular en el caso de reventa de los productos a través de Internet.
3. Está prohibido publicar precios inferiores a las listas de precios vigentes en sitios web sin autenticación.

### Reserva de propiedad y condiciones de pago

1. Cualquier reclamación no podrá, en ningún caso, tener como efecto el retraso o la suspensión de los pagos.
2. Además, en situaciones de retraso en el pago, el Cliente será deudor de derecho, para con Sambonet Paderno Industrie S.p.A. de una indemnización a tanto alzado por los gastos de requerimiento igual a € 40,00. Si los gastos de requerimiento son más altos que la cantidad mencionada anteriormente, Sambonet Paderno Industrie S.p.A. tendrá derecho a solicitar una compensación adicional.
3. En caso de falta de pago de toda o parte de la factura, o de empeoramiento de la situación financiera del Cliente, Sambonet Paderno Industrie S.p.A. también tendrá el derecho de:
  - a) suspender o cancelar los pedidos y las entregas en curso;
  - b) exigir un pago por adelantado para los pedidos y/o garantías de pago sucesivos.

### Entrega

1. Los plazos de entrega se indican lo más exactamente posible, pero dependen de las condiciones de abastecimiento y transporte de Sambonet Paderno Industrie S.p.A., que se compromete a poner la máxima diligencia para cumplir con las entregas, excepto en casos de fuerza mayor.
2. Exceder los tiempos de entrega previstos no puede vincular Sambonet Paderno Industrie S.p.A. al pago de sanciones o indemnizaciones por daños e intereses.
3. Cualquier modificación del pedido dará lugar a una consecuente modificación de la fecha de entrega.
4. Se consideran causas de fuerza mayor que liberan Sambonet Paderno Industrie S.p.A. de la obligación de la entrega: guerra, revuelta, incendio, huelgas, imposibilidad de abastecimiento, accidentes especialmente relevantes al equipo de fabricación, la rotura de máquinas, la interrupción o el retraso en el transporte.
5. Sambonet Paderno Industrie S.p.A. informará al Cliente de forma tempestiva sobre cualquier retraso. En cualquier caso, la entrega dentro de los plazos solo se puede realizar si el Cliente ha cumplido debidamente con todas sus obligaciones para con Sambonet Paderno Industrie S.p.A., cualquiera sea la causa.
6. También se acuerda entre las partes que si el Cliente no toma posesión de los productos pedidos bajo las condiciones establecidas, Sambonet Paderno Industrie S.p.A. facturará al Cliente:
  - a) cualquier costo adicional de transporte y/o almacenamiento;
  - b) gastos de custodia equivalentes al 5% del monto del pedido, excluidos los impuestos, para cada mes de retraso.

### Advertencias importantes

1. La percepción del color puede ser subjetiva en función de la geometría, el tamaño, los acabados y la iluminación del entorno. Los productos sometidos al proceso PVD podrían estar sujetos a pequeñas variaciones cromáticas o discontinuidades entre diferentes modelos, entre diferentes referencias o entre partidas diferentes del mismo producto. Dichas variaciones están comprendidas dentro de límites de tolerancia preestablecidos y estrictamente monitoreados.
2. Al imprimir puede que surjan errores y/o omisiones. Sambonet Paderno Industrie S.p.A. se reserva el derecho a rectificar eventuales errores de impresión o de cálculo.
3. Fotos, datos y medidas que aparecen en este catálogo son indicativos y susceptibles, sin previo aviso, de modificación.
4. Los perfiles de los cubiertos de la lista de precios son meramente simbólicos y no corresponden a los perfiles reales.



## CREDITS

### PHOTO - FOTO

**Riccardo Bianchi**  
**Felice Scoccimarro**

### LOCATIONS

**Ristorante Dolce Stil Novo Alla Reggia, Venaria Reale – Torino, Italia**  
**Ristorante I Gemelli – Milano, Italia**

### COVER - IN COPERTINA

**Alfredo Russo – Michelin-starred chef**

### PRINT - STAMPA

**Graphicscalve S.p.A.**

MEMBER  
OF 

**ARCTURUS** GROUP

### © COPYRIGHT

- Ogni riproduzione anche parziale del presente catalogo è vietata se non espressamente autorizzata per iscritto da Sambonet Paderno Industrie S.p.A.
- This catalogue may not be reproduced in whole or in part unless specific prior written authorization of Sambonet Paderno Industrie S.p.A.
- Die Vervielfältigung dieses Katalogs -auch wenn partial- ohne unsere ausdrückliche schriftliche Erlaubnis ist untersagt.
- Toute reproduction ou reproduction partielle de ce catalogue est interdite sauf expressément autorisée par Sambonet Paderno Industrie S.p.A.
- Queda prohibida la reproducción total o parcial de este catálogo sin autorización de forma expresa y por escrito de Sambonet Paderno Industrie S.p.A.

### NOTE - NOTES

- Le misure, caratteristiche ed illustrazioni dei prodotti sono indicative e soggette a variazioni senza preavviso qualora esigenze tecnico produttive lo richiedessero.
- The pictures illustrated and data are representatives. We reserve the right to alter at any time the specifications stated without notice, whenever technical requirements shall so demand.
- Fotos und Abmessungen sind nur als information zu verstehen. Wir behalten uns das Recht vor, die angegebenen Spezifikationen jederzeit zu ändern, sofern es aus produktionstechnischen Gründen erforderlich ist.
- Les photos et dimensions indiquées sont indicatives. Nous nous réservons le droit de modifier à tout moment les spécifications techniques, si la situation l'exige.
- Fotos, datos y medidas que aparecen en este catálogo son indicativos y susceptibles, sin previo aviso, de modificación por exigencias técnicas o de producción.







**SAMBONET PADERNO INDUSTRIE S.P.A.**

Via Giovanni Coppo 1,C - 28060 Orfengo (NO) - Italy

Ph. +39 0321 1916 601

Fax +39 0321 1916 890

[horeca@paderno.it](mailto:horeca@paderno.it)

[www.paderno.it](http://www.paderno.it)

**ROSENTHAL SAMBONET USA LTD.**

685 Route 10 - Randolph NJ 07869 - USA

Ph. +1 201 804 8000

Fax +1 201 842 9195

[info@rosenthalusa.com](mailto:info@rosenthalusa.com)

[www.rosenthal-hotel-restaurant.com](http://www.rosenthal-hotel-restaurant.com)

MEMBER  
OF   
ARCTURUS GROUP

XA1002 - Ed. 7/2021

